

AVerMedia®

AVer™ DiGi

NV Card Series

NV3000T/5000T/6000T/7240/7480/8416T/9416T

Digital Video Recording System

User's Manual

FCC NOTICE

This device complies with Part 15 of the FCC Rules. Operation is subject to the following two conditions: (1) this device may not cause harmful interference, and (2) this device must accept any interference received, including interference that may cause undesired operation.

Federal Communications Commission Statement

NOTE- This equipment has been tested and found to comply with the limits for a Class A digital device, pursuant to Part 15 of the FCC Rules. These limits are designed to provide reasonable protection against harmful interference in a residential installation. This equipment generates uses and can radiate radio frequency energy and, if not installed and used in accordance with the instructions, may cause harmful interference to radio communications. However, there is no guarantee that interference will not occur in a particular installation. If this equipment does cause harmful interference to radio or television reception, which can be determined by tuning the equipment off and on, the user is encouraged to try to correct the interference by one or more of the following measures:

Reorient or relocate the receiving antenna.

Increase the separation between the equipment and receiver.

Connect the equipment into an outlet on a circuit different from that to which the receiver is connected.

Consult the dealer or an experienced radio/television technician for help.

CE NOTICE

This product is herewith confirmed to comply with the requirements set out in the Council Directives on the Approximation of the laws of the Member States relating to Electromagnetic Compatibility Directive 2004/108/EEC.

Warning - This is a Class A product. In a domestic environment this product may cause radio interference in which case the user may be required to take adequate measures to correct this interference.

DISCLAIMER

No warranty or representation, either expressed or implied, is made with respect to the contents of this documentation, its quality, performance, merchantability, or fitness for a particular purpose. Information presented in this documentation has been carefully checked for reliability; however, no responsibility is assumed for inaccuracies. The information contained in this documentation is subject to change without notice.

In no event will AVerMedia® be liable for direct, indirect, special, incidental, or consequential damages arising out of the use or inability to use this product or documentation, even if advised of the possibility of such damages.

TRADEMARKS

"AVerMedia" is a registered trademark of AVerMedia Technologies, Inc and has been authorized AVerMedia Information Inc to use. "AVerDiGi" and "AVer" are trademarks (or registered trademarks) of AVerMedia Information, Inc. All other products or corporate names mentioned in this documentation are for identification and explanation purposes only, and may be trademarks or registered trademarks of their respective owners.

COPYRIGHT

© 2011 AVerMedia Information, Inc. All rights reserved. No part of this document may be reproduced, transmitted, transcribed, stored in a retrieval system, transmitted in any form, or translated into any language by any means (electronically, mechanically, photocopied, recorded, etc.) without the prior written permission of AVerMedia. Information in this document is subject to change without notice. The information contained herein is for informational purposes only and shall not be considered legally binding.

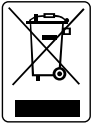

Following information is only for EU-member states:

The use of the symbol indicates that this product may not be treated as household waste. By ensuring this product is disposed of correctly, you will help prevent potential negative consequences for the environment and human health, which could otherwise be caused by inappropriate waste handling of this product. For more detailed information about recycling of this product, please contact your local city office, your household waste disposal service or the shop where you purchased the product.

TABLE OF CONTENTS

CHAPTER 1	INTRODUCTION	1
	NV3000T PACKAGE	1
	NV3000T OPTIONAL ACCESSORIES.....	1
	NV5000T PACKAGE	1
	NV5000T VIDEO EXTENSION CARD PACKAGE (OPTIONAL)	1
	NV5000T OPTIONAL ACCESSORIES.....	2
	NV6000T PACKAGE	2
	NV7240/7480 PACKAGE	3
	NV8416T PACKAGE	3
	NV9416T PACKAGE	4
	OSD KIT (OPTIONAL)	4
	NV3000T CARD PARTS	5
	NV5000T CARD PARTS	5
	NV 6000T CARD PARTS	5
	NV7240/7480 CARD PARTS	6
	NV8416T CARD PARTS	6
	NV9416T CARD PARTS	7
	IR USB RECEIVER PART & CONNECTION	7
CHAPTER 2	HARDWARE INSTALLATION	8
2.1	MINIMUM SYSTEM REQUIREMENTS.....	8
2.2	SYSTEM REQUIREMENT AND PERFORMANCE RECOMMENDATION	12
2.2.1	Pure NVR.....	12
2.2.2	Hybrid DVR	14
2.3	NV3000T/5000T/6000T/7240/7480/8416T/9416T HARDWARE COMBINATIONS	16
2.4	NV3000T HARDWARE INSTALLATION.....	18
2.4.1	Installing NV3000T and I/O Audio cards (optional).....	18
2.4.2	Installing (2) NV3000T and (2) I/O Audio cards (optional)	18
2.4.3	Installing (4) NV3000T cards	19
2.5	NV5000T HARDWARE INSTALLATION.....	19
2.5.1	Installing NV5000T Card	19
2.5.2	Installing NV5000T and I/O Audio cards	20
2.5.3	Installing NV5000T and (3) BNC video extension cards.....	20
2.5.4	Installing NV5000T, I/O Audio (optional) and BNC video extension card (optional)	21
2.5.5	Installing NV5000T and Video extension card (optional).....	21
2.5.6	Installing NV5000T, Video extension card (optional), and I/O Audio (optional)	22
2.6	NV6000T HARDWARE INSTALLATION.....	23

2.6.1	Installing (2) NV6000T card.....	23
2.6.2	Installing NV6000T and I/O card.....	23
2.7	NV7240/NV7480 HARDWARE INSTALLATION	24
2.7.1	Installing NV7240/NV7480 card.....	24
2.7.2	Installing NV7240/NV7480 and I/O card	24
2.7.3	Installing NV7240/NV7480, I/O card, and Display 21 card (optional)	25
2.8	NV8416T HARDWARE INSTALLATION.....	26
2.8.1	Install NV8416T card.....	26
2.8.2	Install (2) NV8416T cards.....	26
2.8.3	Install NV8416T card and I/O card (optional).....	27
2.8.4	Install NV8416T card, I/O card (optional), and Display 21 card (optional)	27
2.9	NV9416T HARDWARE INSTALLATION.....	28
2.9.1	Install NV9416T card.....	28
2.9.2	Install NV9416T, Display 21 card (optional) and I/O card.....	29
2.10	CONNECTING THE WATCHDOG LINE	30
2.10.1	Connecting the Watchdog line to NV3000T/5000T	30
2.10.2	Connecting the Watchdog line to NV6000T	30
2.10.3	Connecting the Watchdog line to NV7240/NV7480.....	31
2.10.4	Connecting the Watchdog line to NV8416T	31
2.10.5	Connecting the Watchdog line to NV9416T	31
2.11	CONNECTING THE CAMERAS, A TV AND AUDIO DEVICE	32
2.11.1	Connecting the Cameras, a TV and Audio device to NV3000T/5000T	32
2.11.2	Connecting the Cameras, a TV and Audio devices to NV6000T	33
2.11.3	Connecting the Cameras, a TV and Audio devices to NV7240/NV7480	34
2.11.4	Connecting the Cameras, a LCD Monitor, and Audio devices to NV8416T	35
2.11.5	Connecting the Cameras, a TV and Audio devices to NV9416T	36
2.12	DUAL MONITORS SETUP.....	37
2.12.1	Graphic card with ATi chipset.....	37
2.12.2	Graphic card with NVIDIA chipset.....	39
2.13	CONNECTING AN I/O BOX TO NV3000T/5000T I/O AUDIO CARD	40
2.13.1	I/O box Sensor and Relay pinhole allocation:	40
2.13.2	I/O box pin definition.....	41
2.14	CONNECTING THE SENSOR/RELAY DEVICE TO NV6000T/7240/7480/8416T/9416T I/O CARD..	42
2.14.1	I/O Card Sensor and Relay pinhole allocation:	42
2.15	THE SENSOR INPUT AND RELAY OUTPUT SPECIFICATIONS	43
2.16	CONNECTING POS (POINT OF SALES).....	44

CHAPTER 3	SOFTWARE INSTALLATION	45
3.1	INSTALLING NV DVR SOFTWARE AND DRIVERS IN WINDOWS XP/VISTA/7	46
CHAPTER 4	USING THE NV DVR SOFTWARE	47
4.1	RUNNING THE NV DVR SOFTWARE	47
4.2	USING THE VIRTUAL KEYBOARD	47
4.3	FAMILIARIZING THE BUTTONS IN PREVIEW/ADVANCED MODE	48
4.3.1	Using Event Log Viewer	55
	Using POS Viewer	56
	Using Counting Log Viewer	57
	Using the Object Log Viewer	59
4.4	FAMILIARIZING THE BUTTONS IN COMPACT MODE	60
4.5	FAMILIARIZING THE BUTTONS IN PLAYBACK MODE	61
4.6	WATERMARK VERIFICATION	66
4.7	FAMILIARIZING THE BUTTONS IN PTZ CAMERA CONTROLLER	67
4.8	SETTING UP AND USING THE EMAP	68
4.8.1	To Use the Emap	69
4.9	TO CUT AND SAVE THE WANTED PORTION OF THE RECORDED VIDEO	70
4.10	TO BOOKMARK A SECTION OF THE VIDEO	71
4.11	TO SEARCH USING THE VISUAL SEARCH	72
4.12	TO SEARCH USING THE EVENT SEARCH	73
4.13	TO SEARCH USING THE INTELLIGENT SEARCH	74
4.14	TO SETUP THE PTZ/IP PTZ CAMERA	75
4.14.1	Setup the PTZ Camera	75
4.14.2	Setup the IP PTZ Camera	77
CHAPTER 5	CUSTOMIZING THE NV DVR SYSTEM	79
5.1	SYSTEM SETTING	79
5.1.1	To Set the POS Setting	95
	General Setting	95
	Setup POS Device	97
	Advanced Setting	101
	POS Database Setting	101
5.1.2	Operating the System Controller	102
	Hardware Introduction	102
	Hardware Installation	107
	Operating the System Controller Pro	111
	Upgrading the Firmware of the System Controller	112

Switching to USB DVR Mode	113
Switching to 485 DVR Mode	114
Switch Control on Multiple DVR Servers	115
Familiarizing with LCD Screen	116
Operating the LCD Menu	117
Select a Camera	119
Locking System Operation	120
Trigger the Alarm Button	121
To Playback the Recorded File.....	122
To Playback the Recorded File.....	122
To View the Emap.....	124
PTZ Operation	125
Using the Joystick to Operate the PTZ Camera	125
TO FOCUS THE OBJECT	126
ADJUSTING THE BRIGHTNESS OF THE IMAGE	126
SETUP PRESET POSITION AND USE PRESET.....	127
Enabling the AutoPan	128
Using Digital Zoom	130
Multi-Functions Menu.....	131
SELECT A MONITOR LAYOUT.....	131
CAMERA SETUP	132
SERVER SETUP.....	140
CONTROLLER SETUP.....	144
Operating in PTZ 485 Mode	154
SWITCHING TO THE PTZ 485 MODE.....	154
SELECT THE PROTOCOL OF THE PTZ CAMERA	156
SETUP THE BAUDRATE OF THE PTZ CAMERA.....	157
CONTROLLER SETUP	158
5.2 CAMERA SETTING	166
5.2.1 Setup the Object Counting	173
5.2.2 To Setup the FaceFinder	175
5.2.3 Setup PTZ Tracking.....	177
5.2.4 Create a Camera Group	179
5.3 RECORDING SETTING.....	182
5.3.1 To Mask/Shield an area on the screen.....	188
5.3.2 To show and change the color of the Mask.....	188
5.3.3 To Playback Encrypted Video.....	188

5.4	NETWORK SETTING.....	189
5.5	SCHEDULE SETTING.....	192
5.5.1	To set schedule at a specific portion of time in that hour:.....	194
5.6	BACKUP SETTING	195
5.6.1	Setup Quick Backup.....	196
5.7	SENSOR SETTING	197
5.8	RELAY SETTING	198
5.8.1	To Setup External I/O Box	199
5.9	ALARM SETTING	202
5.9.1	To Setup Alarm Relay.....	209
5.9.2	To Setup the Alarm Sound Setting.....	209
5.9.3	To Setup Call Out List.....	210
5.9.4	To Setup Send E-mail Setting.....	211
5.9.5	To Setup FTP Setting	212
5.9.6	To Setup Alarm Recording Setting.....	212
5.9.7	To Setup SMS/MMS Setting.....	213
5.9.8	To Setup PTZ Preset Point	214
5.9.9	To Setup Alarm SOP	214
5.9.10	To Setup CMS Setting	214
5.9.11	To Setup POS Keyword Setting.....	215
5.9.12	Missing, Suspicious Object, and Scene Change Detected.....	216
5.10	USER SETTING	218
CHAPTER 6	PLAYBACK BACKUP VIDEO	220
6.1	FAMILIARIZING QPLAYER BUTTONS	220
CHAPTER 7	FUNCTIONAL KEYS AND DEBUG TOOL	223
7.1	USING FUNCTIONAL KEYS.....	223
7.2	USING DEBUG TOOL	224
CHAPTER 8	USING THE REMOTE PROGRAMS	225
8.1	FAMILIARIZING THE NV DVR WEBVIEWER BUTTONS	226
8.1.1	To Setup Remote System Setting.....	228
	Basic Setting.....	228
	Advance Setting.....	230
	System Setting	230
	Camera Setting	234
	Record Setting.....	236

Network Setting.....	240
Schedule Setting.....	243
Alarm Setting.....	245
8.2 FAMILIARIZING THE WEBVIEWER PTZ BUTTONS.....	250
8.3 FAMILIARIZING THE REMOTE CONSOLE BUTTONS.....	251
8.3.1 To Setup Remote Console Setting.....	252
8.4 FAMILIARIZING THE BUTTONS IN PTZ CAMERA CONTROLLER.....	254
8.5 USING THE REMOTE PLAYBACK.....	255
8.5.1 Familiarizing the Local Playback Buttons.....	257
8.5.2 Familiarizing the RealTime Playback Buttons.....	260
8.5.3 Familiarizing the Download and Playback Buttons.....	263
8.6 USING HANDYVIEWER TO ACCESS NV DVR SERVER.....	265
8.7 USING PDAVIEWER TO ACCESS NV DVR SERVER.....	265
8.7.1 To install PDAViewer thru ActiveSync.....	265
8.7.2 To install PDAViewer from the Internet.....	266
8.7.3 To Use the PDAViewer.....	267
8.7.4 To Playback in PDAViewer.....	268
8.8 USING JAVAVIEWER TO ACCESS NV DVR SERVER.....	270
8.8.1 To install JavaViewer from the DVR Server.....	270
8.8.2 To Use the JavaViewer.....	270
8.9 USING IPHONE TO ACCESS REMOTE DVR SERVER.....	272
8.9.1 Download the iViewer.....	272
I. Download through the PC.....	272
II. Using iPhone to Download.....	273
8.9.2 Using the iViewer.....	274
8.9.3 To Add DVR Server into DVR List.....	278
8.9.4 Using PTZ Function.....	280
8.10 USING BLACKBERRY PHONE TO ACCESS DVR SERVER.....	282
8.10.1 Download through the BlackBerry Desktop Manager.....	282
8.10.2 Using BlackBerry Phone to Download iBBViewer.....	285
8.10.3 Using the iBBViewer.....	287
CHAPTER 9 IMAGE VERIFICATION.....	289
9.1 TO RUN THE IMAGEVERIFICATION PROGRAM.....	289
CHAPTER 10 IENHANCE.....	290
10.1 TO USE IStABLE.....	291

CHAPTER 11	WEB TOOLS	292
11.1	DISPATCH SERVER.....	292
11.1.1	To Run Dispatch program.....	292
11.2	REMOTE SETUP.....	293
11.2.1	To Add DVR server.....	293
11.2.2	To Setup Remote DVR Server.....	294
	Network Setting.....	304
11.3	REMOTE BACKUP.....	314
11.4	IMATRIX APPLICATION.....	317
11.4.1	Software Installation.....	318
	Minimum System Requirements.....	318
	Installing the iMatrix Software in Windows XP/Vista/7.....	318
11.4.2	Using the iMatrix.....	320
	Running the iMatrix Software.....	320
	Using the iMatrix Application.....	320
	Using Monitor Controller.....	322
	Familiarizing the Buttons in PTZ Camera Controller.....	324
11.4.3	Customizing the iMatrix System.....	325
	System Setting.....	325
	DVR Setup.....	326
	Camera Setup.....	328
	User Setting.....	331
11.4.4	Using the Playback Function.....	332
CHAPTER 12	USING THE REMOTE CONTROL SERVER	334
APPENDIX A	REGISTERING DOMAIN NAMES	335
APPENDIX B	CONFIGURE UPNP	339
	ENABLING UPNP IN WINDOW XP.....	339
APPENDIX C	NETWORK SERVICE PORT	341
APPENDIX D	MOBILE VIEWER COMPARISON	342
	LIMITED WARRANTY.....	343

Manual Conventions

The following conventions are used throughout this manual.



Caution symbol is intended to alert the user of the important installation and operating instructions. Fail to comply may damage the system.



Information symbol is intended to provide additional information for the purpose of clarification.

NOTICE



- INFORMATION IN THIS DOCUMENT IS SUBJECT TO CHANGE WITHOUT NOTIEC.
 - THE INFORMATION CONTAINED HEREIN IS TO BE CONSIDERED FOR REFERENCT ONLY.
-

Chapter 1 Introduction

AVerMedia AVerDVR is a 32-bit PCI video capture card that works as a digital video surveillance system. It enables you to capture true color images and real-time videos from 4 up to 16 camera inputs simultaneously.

With the latest Motion Detection technology, you no longer need to monitor every single moment of the day; the system automatically records and triggers an alarm when any movement is detected.

NV3000T Package

NV3000T package includes the following:

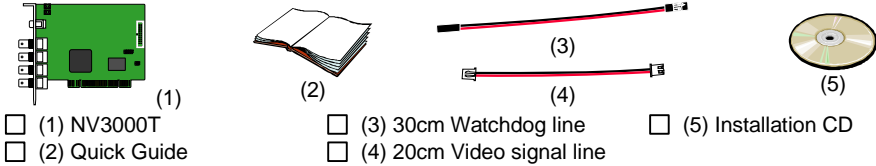

NV3000T Optional Accessories

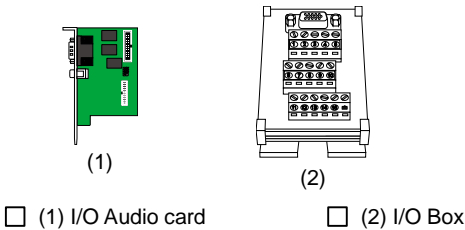

i Please refer to [Chapter 2.14](#) for installation

NV5000T Package

NV5000T package includes the following:

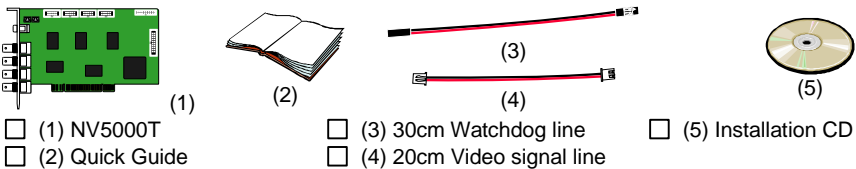

NV5000T Video Extension Card Package (Optional)

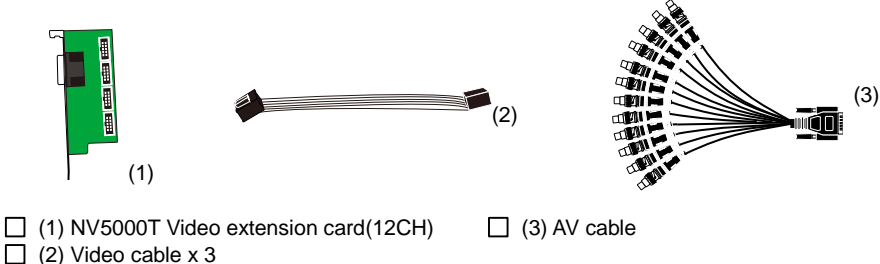

NV5000T Optional Accessories

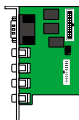

(1)

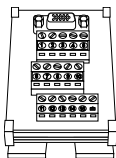

(2)

(1) I/O Audio card

(2) I/O Box



Please refer to [Chapter 2.14](#) for installation

NV6000T Package

NV6000T package includes the following:

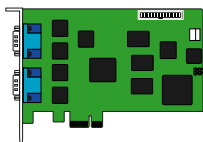

(1)



(2)

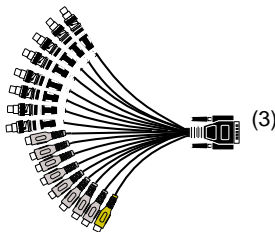

(3)

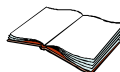

(4)



(5)



(6)



(7)

(1) NV6000T
(6240T/6480T)

(3) 2X AV cable

(5) Installation CD

(7) I/O cable

(2) I/O card

(4) Quick Guide

(6) 30cm Watchdog line

NV7240/7480 Package

NV7480 package includes the following:

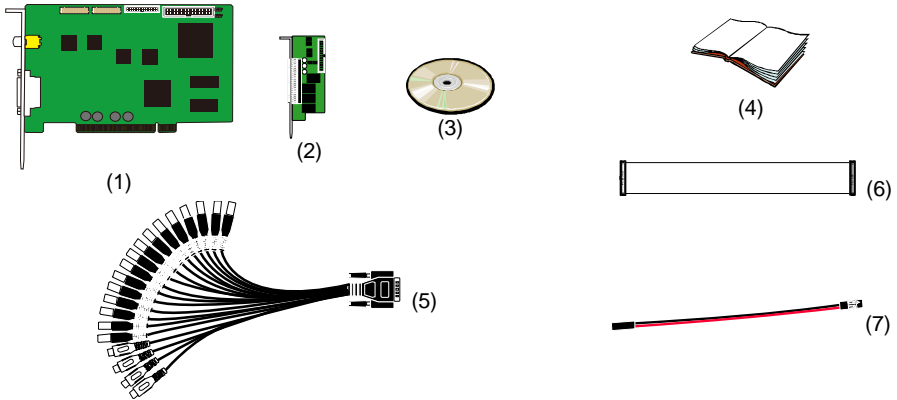

- (1) NV7240/7480
- (2) I/O card
- (3) Installation CD
- (4) Quick Installation Guide
- (5) AV cable
- (6) I/O cable
- (7) Watchdog line

NV8416T Package

NV8416T package includes the following:

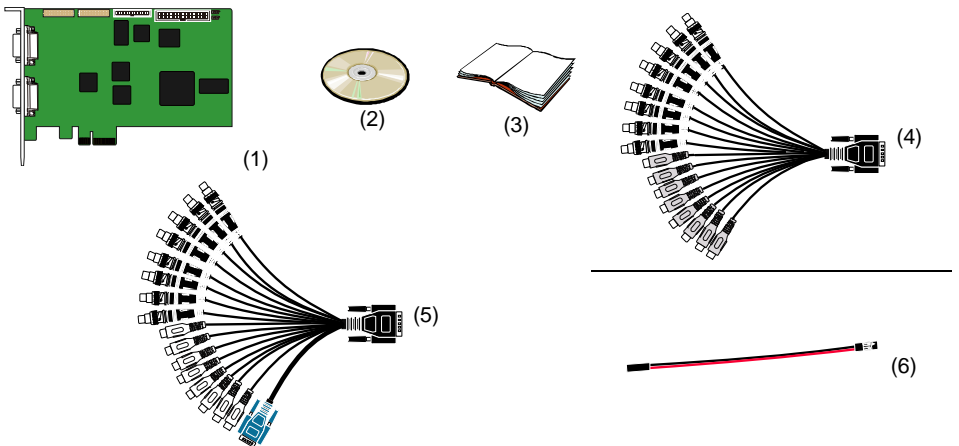

- (1) NV8416T
- (2) Installation CD
- (3) Quick Installation Guide
- (4) AV cable
- (5) AV cable
- (6) Watchdog line

NV9416T Package

NV9416T package includes the following:

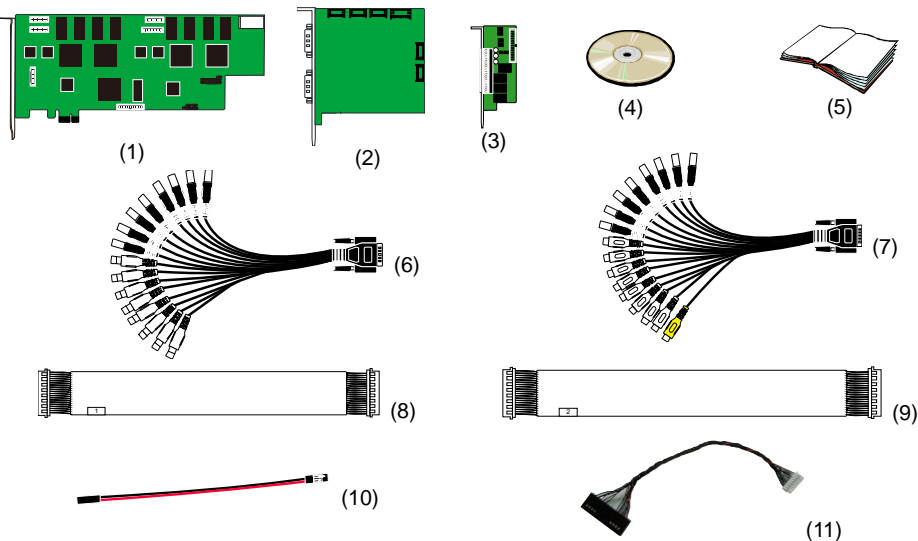

- | | | |
|--|---|--|
| <input type="checkbox"/> (1) NV9416T | <input type="checkbox"/> (5) Quick Installation Guide | <input type="checkbox"/> (9) Audio transmitting cable(#2/27cm) |
| <input type="checkbox"/> (2) Daughter card | <input type="checkbox"/> (6) AV cable | <input type="checkbox"/> (10) Watchdog line |
| <input type="checkbox"/> (3) I/O card | <input type="checkbox"/> (7) AV cable | <input type="checkbox"/> (11) I/O cable |
| <input type="checkbox"/> (4) Installation CD | <input type="checkbox"/> (8) 3x Video transmitting cable(#1/25cm) | |

OSD kit (optional)

This allows you to operate NV DVR with the use of remote control.

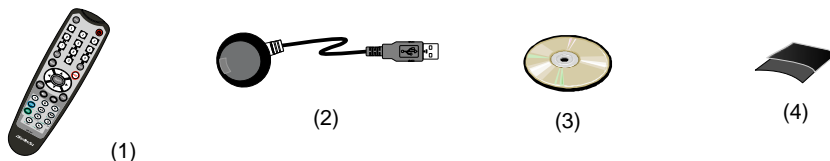

- | | |
|--|--|
| <input type="checkbox"/> (1) Remote Control (batteries included) | <input type="checkbox"/> (3) OSD Installation CD |
| <input type="checkbox"/> (2) IR USB Receiver | <input type="checkbox"/> (4) 2X Velcro Strips |



OSD control is not supported under dual monitor environment.



If there is any damage, shortage or inappropriate item in the package, contact your local dealer immediately.

NV3000T Card Parts

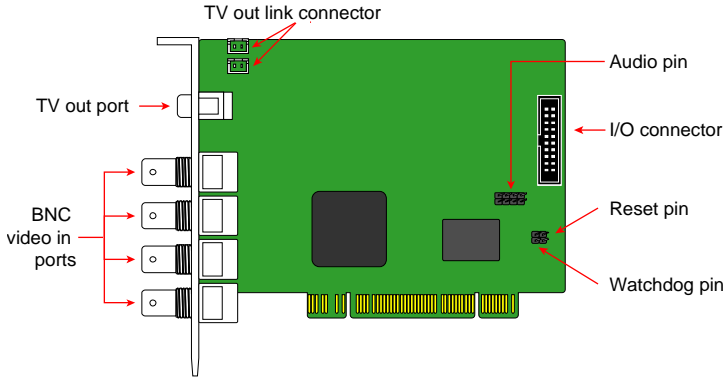

NV5000T Card Parts

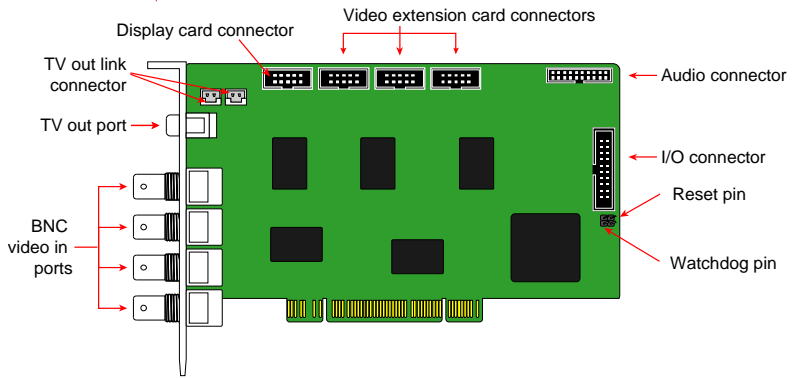

NV 6000T Card Parts

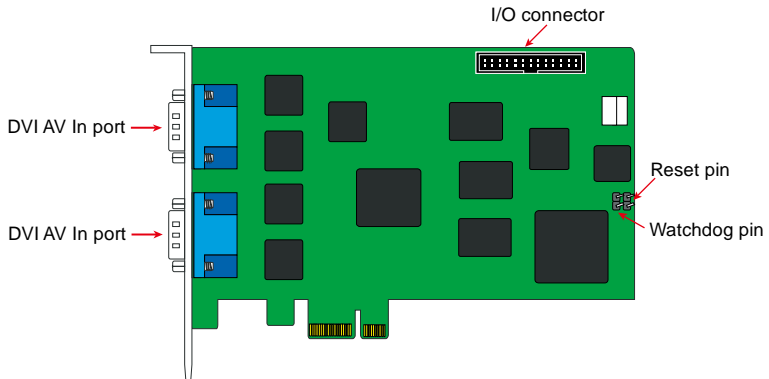

NV7240/7480 Card Parts

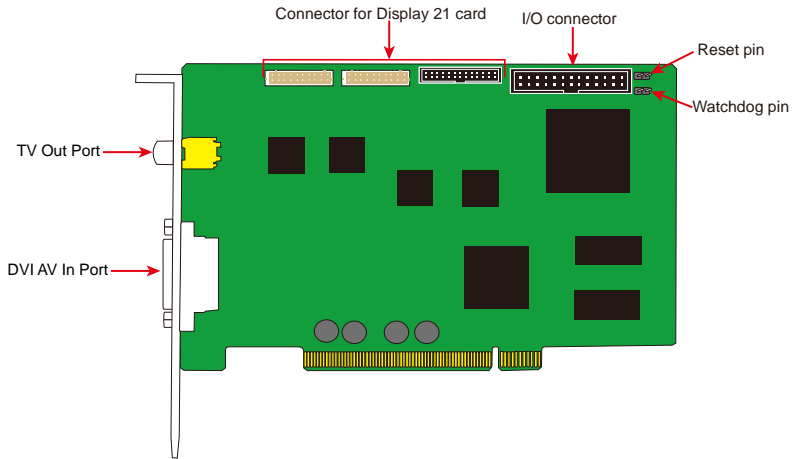

NV8416T Card Parts

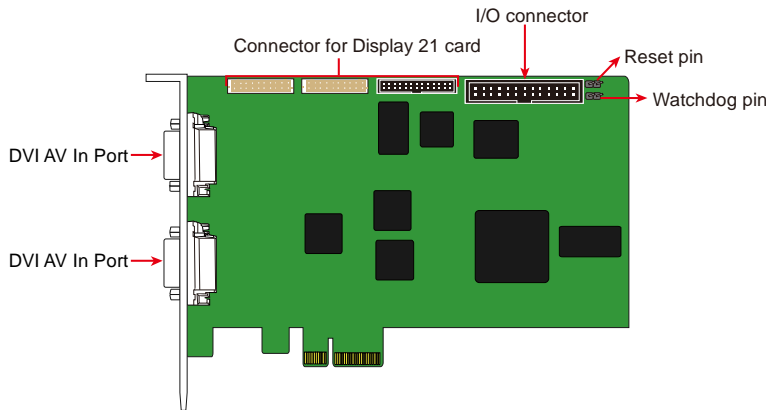

NV9416T Card Parts

NV9416T

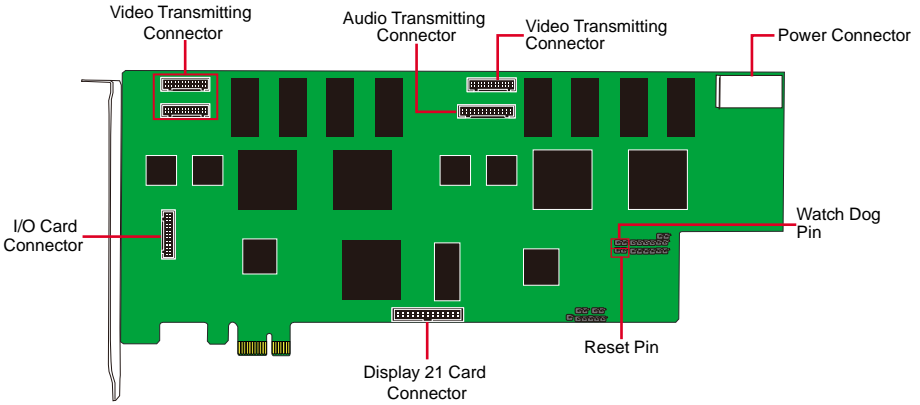

NV9416T Daughter Card

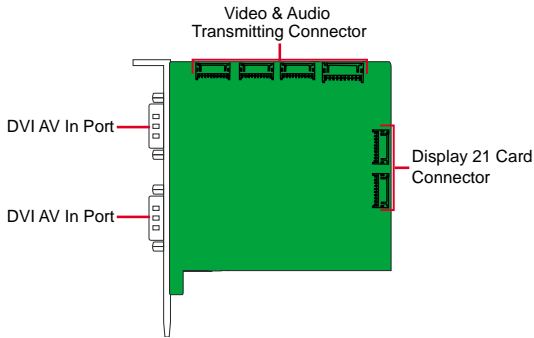

IR USB Receiver Part & Connection

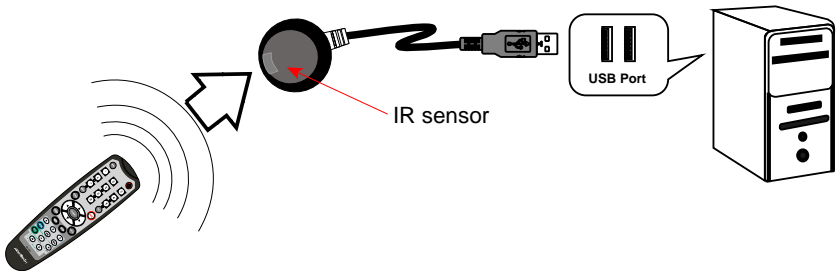

For detail of OSD kit installation, please refer to OSD kit Quick Guide.

Chapter 2 Hardware Installation

2.1 Minimum System Requirements

Verify if the computer meets the minimum system requirements.

NV3000T/5000T:

	NV3000T	NV5000T
CPU	Pentium® 4 2.8GHz or above recommended	
Motherboard	Intel 865, 875, 915, 925, 945, 955, NVIDIA nFORCE4 SLi - Intel Edition Chipset	
OS	Windows XP Professional 32bit /Windows Vista 32bit/Windows 7 32/64bit	
	<p>- For Windows Vista, do the following setting in order to operate DVR normally.</p> <ul style="list-style-type: none">✓ To disable User Account Control (UAC) before enter DVR system. To disable UAC, please go to User Account setting in Control Panel to turn User Account Control off. If UAC doesn't disable, the DVR program will not allow to be installed.✓ Adjust the Display mode to Vista Basic.	
Expansion Slots	1/2/3/4 × 32-bit PCI 2.1 compliant slots	
RAM	DDR 512MB or above	
Hard disk	120GB of free hard disk space, or at least 60GB free space for each partition	
Media	CD-ROM drive	
VGA	16-bit high color SVGA graphic card with DirectDraw & YUV rendering capability, 64MB video memory	
Audio	Sound card and speakers	
Ethernet	10/100/1000 Base-T Ethernet card	

NV6000T/NV7240/NV7480:

CPU	Pentium® 4 2.8GHz or above recommended
Motherboard	Intel 875, 915, 925, 945, 955, NVIDIA nFORCE4 SLi - Intel Edition chipset
OS	Windows XP Professional 32bit /Windows Vista 32bit/Windows 7 32/64bit
	For Windows Vista, do the following setting in order to operate DVR normally. ✓ To disable User Account Control (UAC) before enter DVR system. To disable UAC, please go to User Account setting in Control Panel to turn User Account Control off. If UAC doesn't disable, the DVR program will not allow to be installed. ✓ Adjust the Display mode to Vista Basic .
Expansion Slots	PCI-Ex1 Slot
RAM	DDR 512MB or above
Hard disk	120GB or above
Media	CD-ROM drive
VGA	32-bit high color SVGA graphics card with 128MB video memory and DirectDraw/ YUV Rendering Capability
Audio	Sound card and speakers
Ethernet	10/100/1000 Base-T Ethernet card



For AVerMedia® Security Product Hardware Recommendation list update, go to <http://www.avermedia.com/AVerDiGi/Product/> → AVerDiGi NV series → select the NV card → Hardware Recommendations

NV6000T * 2(32 channels)

CPU	Intel Core 2 Duo E6600 2.4 GHz
Motherboard	Motherboard with Intel 865 / 945 / 955 / P35 / P45 chipsets
OS	Windows XP Professional 32bit /Windows Vista 32bit/Windows 7 32/64bit
	For Windows Vista, do the following setting in order to operate DVR normally. ✓ To disable User Account Control (UAC) before enter DVR system. To disable UAC, please go to User Account setting in Control Panel to turn User Account Control off. If UAC doesn't disable, the DVR program will not allow to be installed. ✓ Adjust the Display mode to Vista Basic .
Expansion Slots	2 * PCI-Express x1 slots
RAM	1GB or above
Hard disk	120GB or above
Media	CD-ROM drive
VGA	32-bit high color SVGA graphics card with 128MB video memory and DirectDraw/ YUV Rendering Capability
Audio	Sound card and speakers
Ethernet	10/100/1000 Base-T Ethernet card



For AVerMedia® Security Product Hardware Recommendation list update, go to <http://www.avermedia.com/AVerDiGi/Product/> → AVerDiGi NV series → select the NV card → Hardware Recommendations

NV8416T:

Motherboard	Motherboard with Intel 965 / P35 / P45 / X58 chipset http://www.avermedia.com/AVerDiGi/Product/ → AVerDiGi NV series → NV8416T → Hardware Recommendations
CPU	Core2Quad Q6600 2.4Ghz or above
Hard disk	500GB or higher
OS	Windows XP Professional 32bit /Windows Vista 32bit/Windows 7 32/64bit
RAM	2GB or higher
VGA card	32-bit high color SVGA graphics card with 256MB video memory and DirectDraw® / YUV Rendering Capability
Ethernet	10/100/1000 Base-T Ethernet card
Others	PCI-Express x4, Sound card and speakers



- CPU i7 and above 2G RAM is required for 32 channels real time recording.
- To disable **User Account Control (UAC)** before enter DVR system. To disable UAC, please go to User Account setting in Control Panel to turn User Account Control off. **If UAC doesn't disable, the DVR program will not allow to be installed.**

NV9416T:

Motherboard	Suggested motherboard in our website. http://www.avermedia.com/AVerDiGi/Product/ → AVerDiGi NV series → NV9416T → Hardware Recommendations
CPU	Core2Duo E82 2.66GHz CPU is highly recommended
Hard disk	120GB or higher120GB or higher
OS	Windows XP Professional 32bit /Windows Vista 32bit/Windows 7 32bit
RAM	2G or higher
VGA card	64-bit high color SVGA graphics card with 256MB video memory and DirectDraw/ YUV Rendering Capability
PSU	350W
Ethernet	10/100/1000 Base-T Ethernet card



- At least 16MB or above hard disk catch buffer is required for 32 channels real time recording. Please contact your hard disk dealer to make sure the hard disk catch buffer spec.
 - To disable **User Account Control (UAC)** before enter DVR system. To disable UAC, please go to User Account setting in Control Panel to turn User Account Control off. **If UAC doesn't disable, the DVR program will not allow to be installed.**
-

2.2 System Requirement and Performance Recommendation

Verify if the computer meets the minimum system requirements from the below chart in order to meet the demand of the performance.

2.2.1 Pure NVR

User can calculate the total resolution (MegaPixel) of IP cameras that plans to connected and map to the below chart to find out the system requirement and performance.

System Requirement:

Total MegaPixel (MP)	1 ~ 4	5 ~ 8	9 ~ 16	17 ~ 20	21 ~ 24	25 ~ 28	29 ~ 32
CPU	Intel P4 2.8 GHz		Intel Core 2 Duo E6400 2.4GHz		Intel Core 2 Quad Q6600 2.4GHz		
RAM	1 GB		2GB		4GB		
VGA	nVidia GeForce 7300GS 256 MB or above			nVidia GeForce 8500 GT 256 MB or above			
Ethernet	100 BaseT			Gigabit LAN			

Guaranteed performance with above system requirement

Total MegaPixel (MP)	1 ~ 4	5 ~ 8	9 ~ 16	17 ~ 20	21 ~ 24	25 ~ 28	29 ~ 32
OS	Microsoft Windows XP / Windows Vista/Windows 7						
Codec Type	MPEG4						
Record (fps)	1-16 MP			17-32 MP			
	30 fps per Channel						
Preview (fps)	1-16 MP			17-32 MP			
	15 fps per channel			7 fps per channel			

Note:	VGA/D1 = 1/4 MP
	CIF = 1/8 MP

【CASE 1】

8 IP camera in 1.3MP and 8 IP cameras in 2MP

Total MegaPixel is $8 * 1.3MP + 8 * 2MP = 26.4MP$

Therefore, **system requirement:**

Total MegaPixel (MP)	25 ~ 28
CPU	Intel Core 2 Quad Q6600 2.4GHz
RAM	4GB
VGA	nVidia GeForce 8500 GT 256 MB or above
Ethernet	Gigabit LAN

Guaranteed Performance:

Total MegaPixel (MP)	25 ~ 28
OS	Microsoft Windows XP / Windows Vista / Windows 7
Codec Type	MPEG4
Record (fps)	17-32 MP
	30 fps per Channel
Preview (fps)	17-32 MP
	7 fps per channel

【CASE 2】

8 IP cameras in 1.3MP and 4 IP cameras in 2MP

4 D1 mode IP cameras

Total MegaPixel is $8 * 1.3MP + 4 * 2MP + 4 * 0.25(VGA/D1 = 1/4 MP) = 19.4MP$

Therefor, **system requirement:**

Total MegaPixel (MP)	17 ~ 20
CPU	Intel Core 2 Duo E6400 2.4GHz
RAM	2GB
VGA	nVidia GeForce 8500 GT 256 MB or above
Ethernet	100 BaseT

Guaranteed Performance:

Total MegaPixel (MP)	17 ~ 20
OS	Microsoft Windows XP / Windows Vista / Windows 7
Codec Type	MPEG4
Record (fps)	17-32 MP
	30 fps per Channel
Preview (fps)	17-32 MP
	7 fps per channel

2.2.2 Hybrid DVR

User can calculate the requirement value of IP cameras and NV card from below chart to find out the system requirement and performance.

System Requirement:

Total MegaPixel (MP)	1 ~ 4	5 ~ 8	9 ~ 16	17 ~ 20	21 ~ 24	25 ~ 28	29 ~ 32
Requirement Value	400	800	1600	2000	2400	2800	3200

Card Type (card unit: 1)	3000T	5000T	7240	7480	6000T (8ch)	6000T (16ch)	8416T	9416T	Video Ext.
Requirement Value	100	400	400	800	800	1600	3200	1600	100

Value	Below 800	800 ~ 1599	1600 ~ 1999	2000 ~ 2399	2400 ~ 2799	2800 ~ 3199	3200 And Above
CPU	Intel P4 2.8 GHz		Intel Core 2 Duo E6400 2.4GHz		Intel Core 2 Quad Q6600 2.4GHz		
RAM	1 GB		2GB		4GB		
VGA	nVidia GeForce 7300GS 256 MB or above			nVidia GeForce 8500 GT 256 MB or above			
Ethernet	100 BaseT			Gigabit LAN			

Guaranteed performance:

Value	Below 800	800 ~ 1599	1600 ~ 1999	2000 ~ 2399	2400 ~ 2799	2800 ~ 3199	3200 And Above
OS	Microsoft Windows XP / Windows Vista /Windows 7						
Codec Type	MPEG4						
Record (fps)	1-16 MP			17-32 MP			
	30 fps per Channel						
Preview (fps)	1-16 MP			17-32 MP			
	15 fps per channel			7 fps per channel			

Note:	VG/D1 = 1/4 MP
	CIF = 1/8 MP

【CASE 1】

8 IP cameras in 1.3MP and using NV7480 card

IP camera total MegaPixel is $8 * 1.3MP = 10.4$; requirement value is 1600

NV7480 card requirement value is 800

Therefore, value is $1600 + 800 = 2400$

System Requirement would be as following:

Value	2400 ~ 2799
CPU	Intel Core 2 Quad Q6600 2.4GHz
RAM	4GB
VGA	nVidia GeForce 8500 GT 256 MB or above
Ethernet	Gigabit LAN

Guaranteed performance would be as following:

Value	2400 ~ 2799
OS	Microsoft Windows XP / Windows Vista / Windows 7
Codec Type	MPEG4
Record (fps)	17-32 MP
	30 fps per Channel
Preview (fps)	17-32 MP
	7 fps per channel

【CASE 2】

4 IP cameras in 1.3MP, 4 D1 mode IP cameras and using NV7240 card

IP camera total MegaPixel is $4 * 1.3MP + 4 * 0.25MP = 6.2MP$ >> requirement value is 800

NV7240 card requirement value is 400

Therefore, value is $800+400=1200$

System Requirement would be as following:

Value	800 ~ 1599
CPU	Intel P4 2.8 GHz
RAM	1 GB
VGA	nVidia GeForce 7300GS 256 MB or above
Ethernet	100 BaseT

Guaranteed performance would be as following:

Value	800 ~ 1599
OS	Microsoft Windows XP / Windows Vista / Windows 7
Codec Type	MPEG4
Record (fps)	1-16 MP
	30 fps per Channel
Preview (fps)	1-16 MP
	15 fps per channel

2.3 NV3000T/5000T/6000T/7240/7480/8416T/9416T Hardware Combinations

AVerMedia NV DVR provides powerful surveillance functions and flexible hardware combinations. The table shows the numbers of camera inputs, audio inputs, sensor inputs and relay outputs on different hardware combinations.



Before installing the cards, the computer must be turned **OFF**, the power cable must be **UNPLUGGED** and all other cables that are attached at the back of the computer must be **DISCONNECTED**.

When installing multiple cards, it is important to arrange the cards in sequence so that the cables would not tangle up.

NV3000T hardware combinations:

Hardware Combinations		Camera Input	Audio Input	Sensor Input	Relay Output
NV3000T Card	I/O Audio Card				
1	0	4	0	0	0
	1	4	1	4	3
2	0	8	0	0	0
	1	8	1	4	3
	2	8	2	8	6
3	0	12	0	0	0
	1	12	1	4	3
	2	12	2	8	6
4	0	16	0	0	0
	1	16	1	4	3
	2	16	2	8	6

NV5000T hardware combinations:

Hardware Combinations			Camera Input	Audio Input	Sensor Input	Relay Output
NV5000T Card	BNC Video Extension Card	I/O Audio Card				
1	0	0	4	0	0	0
		1	4	4	4	3
	1	0	8	0	0	0
		1	8	4	4	3
	2	0	12	0	0	0
		1	12	4	4	3
		0	16	0	0	0
	3	1	16	4	4	3
		1	16	4	4	3
Hardware Combinations			Camera Input	Audio Input	Sensor Input	Relay Output
NV5000T Card	12CH Video Extension Card	I/O Audio Card				
1	1	0	12	0	0	0
		1	12	4	4	4

NV600T hardware combinations:

Hardware Combinations		Camera Input	Audio Input	Sensor Input	Relay Output
NV6480T Card	IO Card				
1	1	16	16	4	4
Hardware Combinations		Camera Input	Audio Input	Sensor Input	Relay Output
NV6240T Card (8Channels)	IO Card				
1	1	8	8	4	4

NV7240 hardware combinations:

Hardware Combinations		Camera Input	Audio Input	Sensor Input	Relay Output
NV7240 Card	IO Card				
1	0	8	4	0	0
1	1	8	4	4	4

NV7480 hardware combinations:

Hardware Combinations		Camera Input	Audio Input	Sensor Input	Relay Output
NV7480 Card	IO Card				
1	0	16	4	0	0
1	1	16	4	4	4

NV8416T hardware combinations:

Hardware Combinations		Camera Input	Audio Input	Sensor Input	Relay Output
NV8416T Card	IO Card				
1	0	16	16	0	0
2	0	32	32	0	0
1	1	16	16	4	4
2	1	32	32	4	4

NV9416T hardware combinations:

Hardware Combinations		Camera Input	Audio Input	Sensor Input	Relay Output
NV9416T Card	IO Card				
1	0	16	16	0	0
1	1	16	16	4	4
2	0	32	32	0	0
2	1	32	32	4	4

2.4 NV3000T Hardware Installation

2.4.1 Installing NV3000T and I/O Audio cards (optional)



The I/O audio card is an optional item. The D-type I/O port receives and transmit signal from the I/O box where the sensor and relay device are connected to it, while the audio input port receives the signal from the microphone NV3000T card is compatible with I/O Audio card that supports one audio input only.

1. Remove the PC case cover.
2. Remove 2 brackets that cover the PCI slots. Save the screws.
3. Connect the NV3000T card and I/O Audio card with the connection cables.
4. Press the cards into the PCI slots firmly.
5. Secure the cards with the screws.

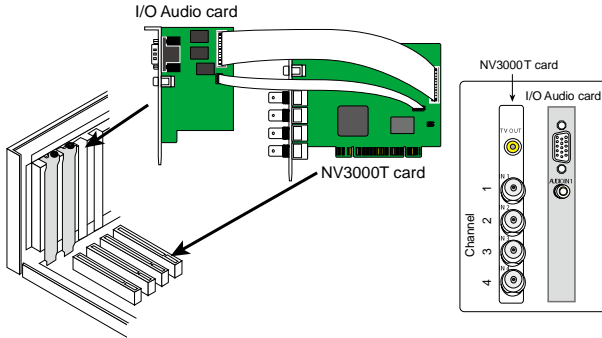

2.4.2 Installing (2) NV3000T and (2) I/O Audio cards (optional)

1. Remove the PC case cover.
2. Remove 4 brackets that cover the PCI slots. Save the screws.
3. Connect the NV3000T card and I/O Audio card with the connection cables.
4. Connect the (2) NV3000T cards with the supplied 20cm video signal line.
5. Press the cards into the PCI slots firmly.
6. Secure the cards with the screws.

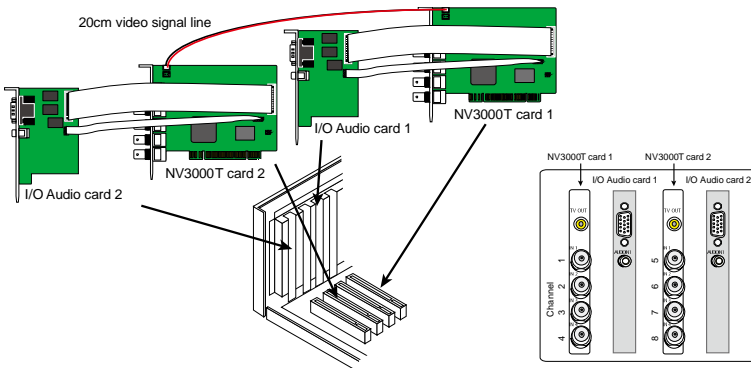

2.4.3 Installing (4) NV3000T cards

1. Remove the PC case cover.
2. Remove 4 brackets that cover the PCI slots. Save the screws.
3. Connect the (4) NV3000T cards with the supplied 20cm video signal line.
4. Press the cards into the PCI slots firmly.
5. Secure the cards with the screws.

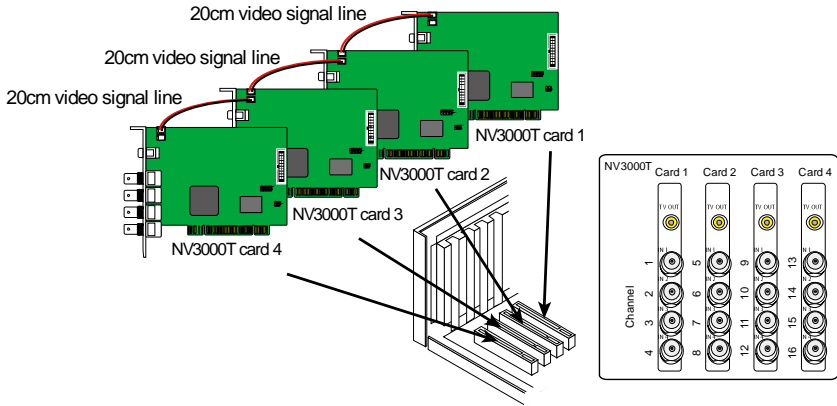

2.5 NV5000T Hardware Installation



NV5000T card only can support 4 IP cameras.

2.5.1 Installing NV5000T Card

1. Remove the PC case cover.
2. Remove a bracket that covers the PCI slot. Save the screw.
3. Press the NV5000T card into the PCI slot firmly.
4. Secure the card with the screws.

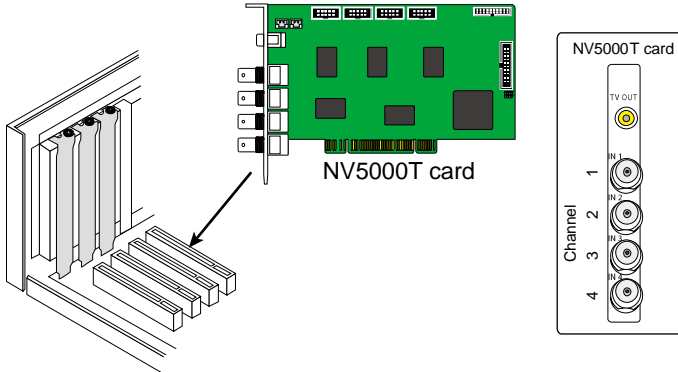

2.5.2 Installing NV5000T and I/O Audio cards



The I/O audio card is an optional item. The D-type I/O port receives and transmit signal from the I/O box where the sensor and relay device are connected to it, while the audio input port receives the signal from the microphone NV5000T card is compatible with the I/O Audio card that supports four (4) audio inputs.

1. Remove the PC case cover.
2. Remove 2 brackets that cover the PCI slots. Save the screws.
3. Connect the NV5000T card and I/O Audio card with the connection cables.
4. Press the cards into the PCI slots firmly.
5. Secure the cards with the screws.

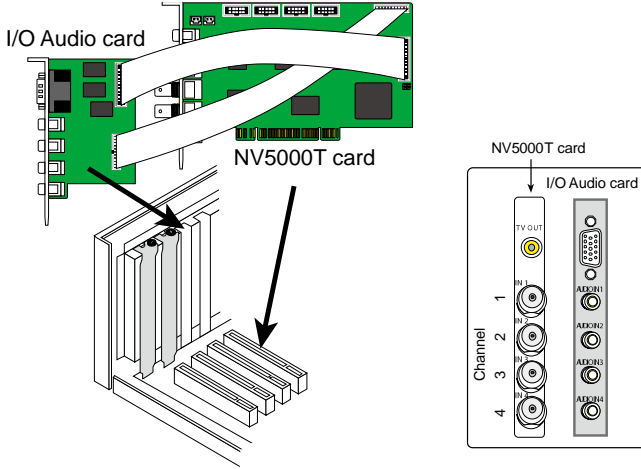

2.5.3 Installing NV5000T and (3) BNC video extension cards



The BNC video extension card is an optional item. It comes with additional four (4) BNC video input ports that provide four (4) extra channels.

1. Remove the PC case cover.
2. Remove 4 brackets that cover the PCI slots. Save the screws.
3. Connect the NV5000T card and BNC video extension cards with the connection cables.
4. Press the cards into the PCI slots firmly.
5. Secure the cards with the screws.

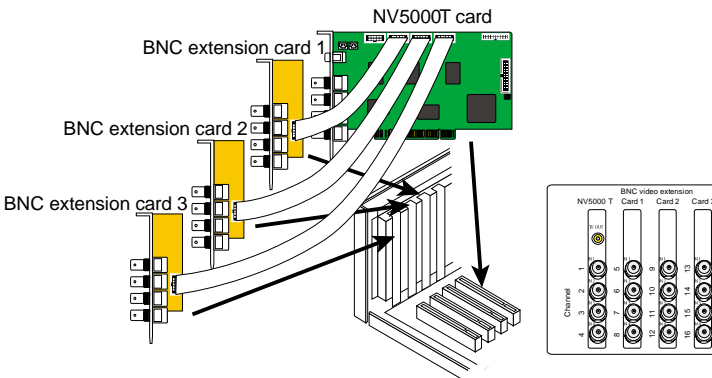

2.5.4 Installing NV5000T, I/O Audio (optional) and BNC video extension card (optional)

1. Remove the PC case cover.
2. Remove 3 brackets that cover the PCI slots. Save the screws.
3. Connect the NV5000T card, BNC video extension card and I/O Audio card with the connection cables.
4. Press the cards into the PCI slots firmly.
5. Secure the cards with the screws.

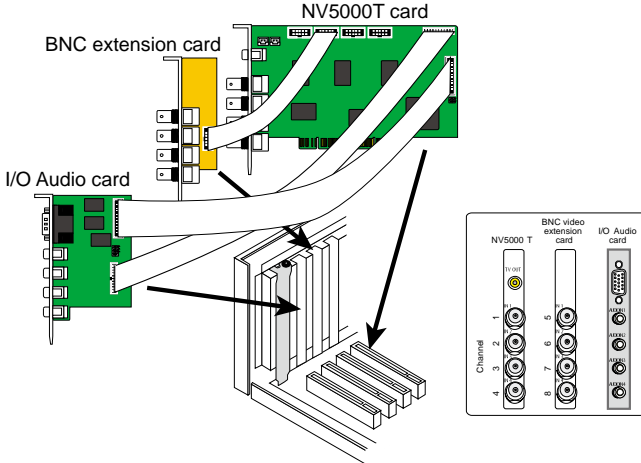

2.5.5 Installing NV5000T and Video extension card (optional)

1. Remove the PC case cover.
2. Remove 2 brackets that cover the PCI slots. Save the screws.
3. Connect the NV5000T card and video extension card with the connection cables.
4. Press the cards into the PCI slots firmly.
5. Secure the cards with the screws.



- The video extension card is an optional item. It comes with additional 12 video input ports that provide 12 extra channels.
- The 1st connector on the video extension card doesn't have function.

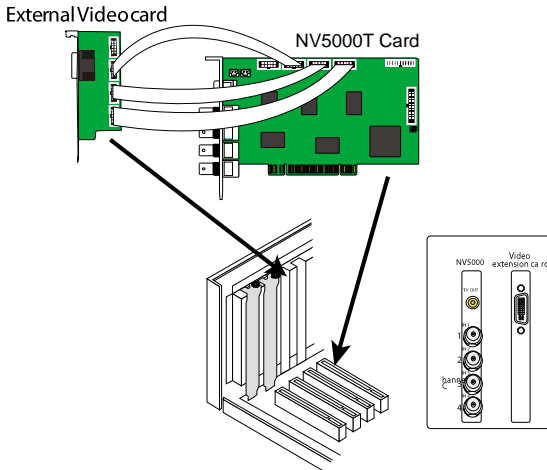

2.5.6 Installing NV5000T, Video extension card (optional), and I/O Audio (optional)

1. Remove the PC case cover.
2. Remove 3 brackets that cover the PCI slots. Save the screws.
3. Connect the NV5000T card, video extension card and I/O Audio card with the connection cables.
4. Press the cards into the PCI slots firmly.
5. Secure the cards with the screws.



- The video extension card is an optional item. It comes with additional 12 video input ports that provide 12 extra channels.
- The 1st connector on the video extension card doesn't have function.

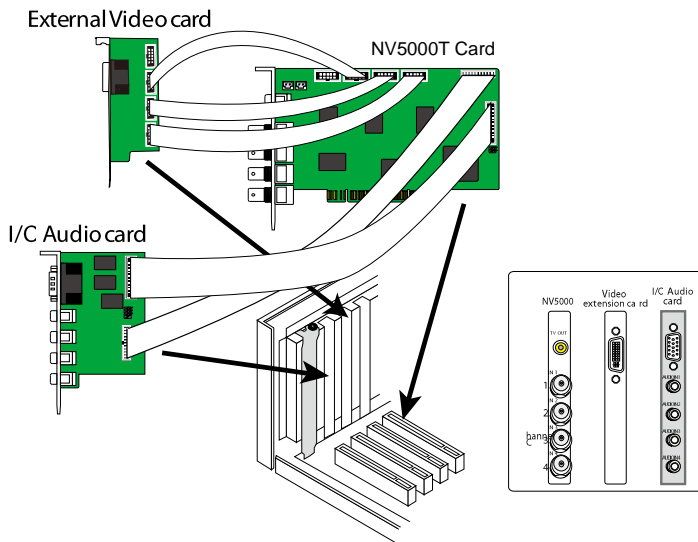

2.6 NV6000T Hardware Installation

The NV6000T can support up to 16 cameras and 8 audio inputs

2.6.1 Installing (2) NV6000T card



The PC motherboard needs to have 2 PCI-Ex1 slots for installing 2 NV6000T card.

1. Remove the PC case cover.
2. Remove 2 brackets that cover the PCI slots. Save the screws.
3. Press the cards into the PCI-Ex1 slot firmly.
4. Secure the card with the screws.
5. Connect the supplied AV connection cable to the DVI AV IN port.

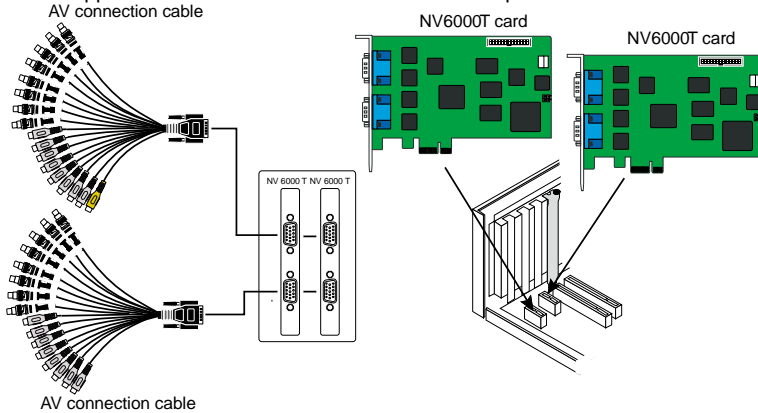

2.6.2 Installing NV6000T and I/O card

1. Remove the PC case cover.
2. Remove 1 bracket that cover the PCI slot and 1 bracket that cover the PCI-Ex slot. Save the screws.
3. Connect the NV6000T card and I/O card with the connection cable.
4. Press the cards into the PCI-Ex1 slots firmly.
5. Secure the card with the screws.
6. Connect the supplied AV connection cable to the DVI AV IN port.

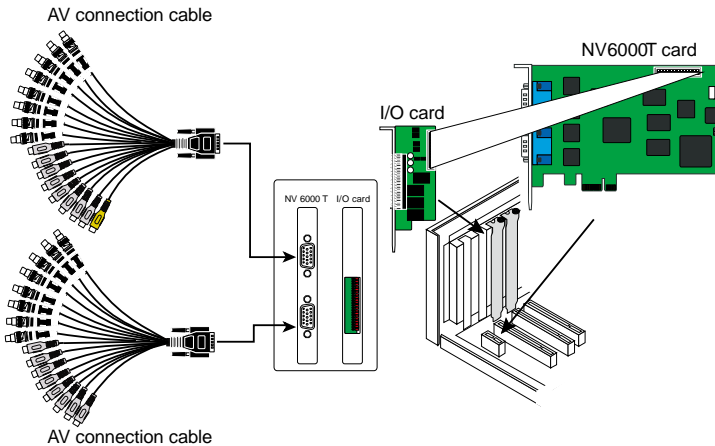

2.7 NV7240/NV7480 Hardware Installation

2.7.1 Installing NV7240/NV7480 card

1. Remove the PC case cover.
2. Remove 1 bracket that cover the PCI slots and save the screws.
3. Press the NV card into the PCI slot firmly.
4. Secure the card with the screws.
5. Connect the supplied AV connection cable to the AV IN port.

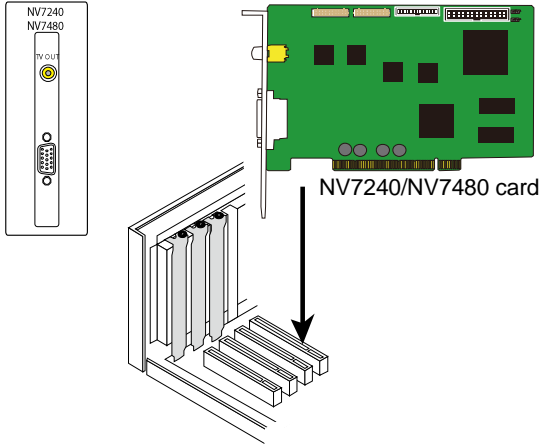

2.7.2 Installing NV7240/NV7480 and I/O card

1. Remove the PC case cover.
2. Remove 2 brackets that cover the PCI slots. Save the screws.
3. Connect the NV card and I/O card with the I/O cable.
4. Press the cards into the PCI slot firmly.
5. Secure the card with the screws.
6. Connect the supplied AV connection cable to the AV IN port.

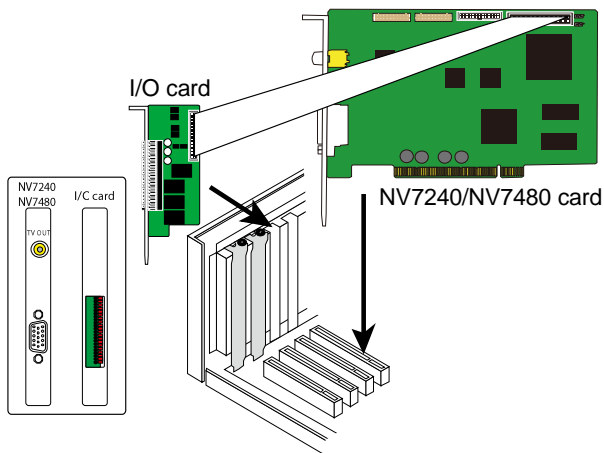

2.7.3 Installing NV7240/NV7480, I/O card, and Display 21 card (optional)

1. Remove the PC case cover.
2. Remove 3 brackets that cover the PCI slots. Save the screws.
3. Connect the NV card, /O card, and Display 21 card with the connection cable.
4. Press the cards into the PCI slot firmly.
5. Secure the card with the screws.
6. Connect the supplied AV connection cable to the AV IN port.

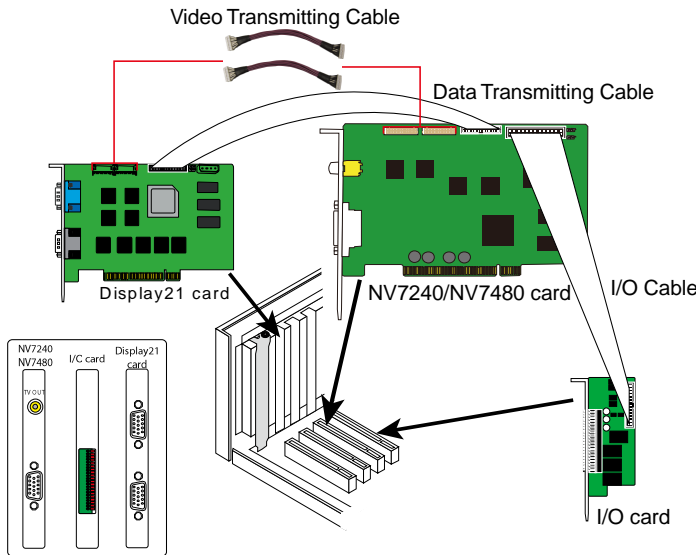

2.8 NV8416T Hardware Installation

2.8.1 Install NV8416T card

1. Remove the PC case cover.
2. Remove 1 bracket that covers the PC-Ex4I slot. Save the screws
3. Press the NV8416T card into the PCI-Ex4slot firmly.
4. Secure all the cards with the screws.
5. Connect the supplied AV connection cables to the AV IN ports.

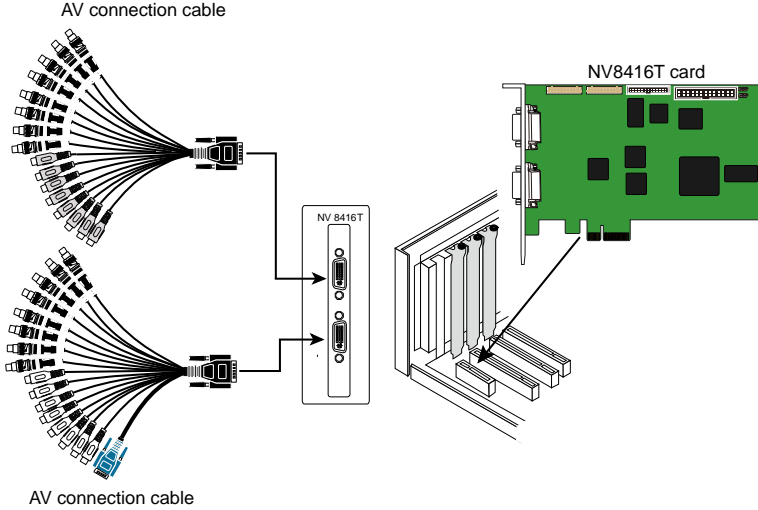

2.8.2 Install (2) NV8416T cards

1. Remove the PC case cover.
2. Remove 2 brackets that cover the PCI-Ex4 slot. Save the screws
3. Press the NV8416T cards into the PCI-Ex4 slot firmly.
4. Secure all the cards with the screws.
5. Connect the supplied AV connection cables to the AV IN ports.

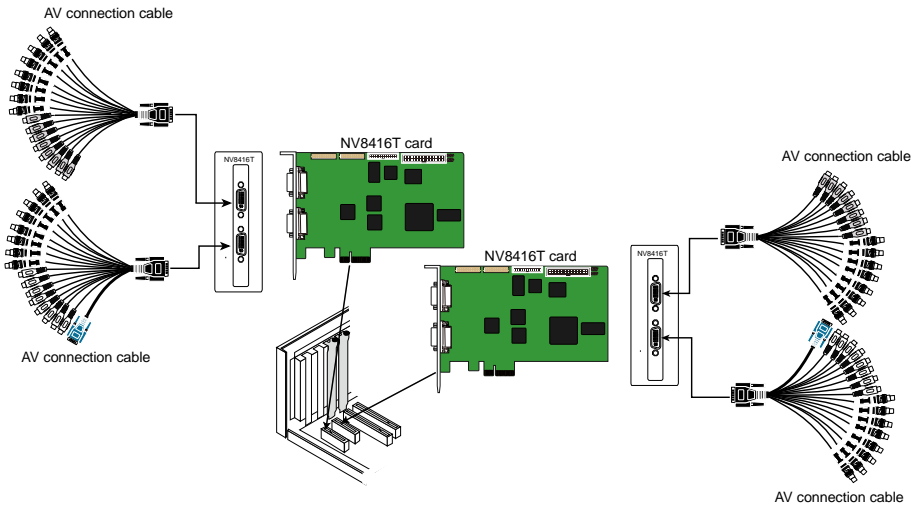

2.8.3 Install NV8416T card and I/O card (optional)

1. Remove the PC case cover.
2. Remove 1 bracket that cover the PC-Ex4 slot and 1 bracket that cover the PCI slot. Save the screws
3. Press the NV8416T card into the PCI-Ex4 slot and I/O card into the PCI slot firmly.
4. Secure all the cards with the screws.
5. Connect the supplied AV connection cables to the AV IN ports.

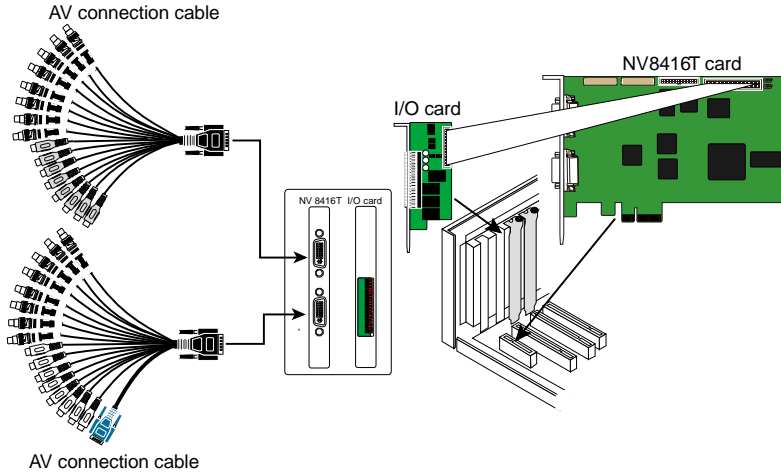

2.8.4 Install NV8416T card, I/O card (optional), and Display 21 card (optional)

1. Remove the PC case cover.
2. Remove 2 brackets that cover the PCI slot and 1 bracket that cover the PCI-Ex4 slot. Save the screws
3. Press the NV8416T card into the PCI-Ex4 slot and I/O card and Display 21 card into the PCI slot firmly.
4. Secure all the cards with the screws.
5. Connect the supplied AV connection cables to the AV IN ports.

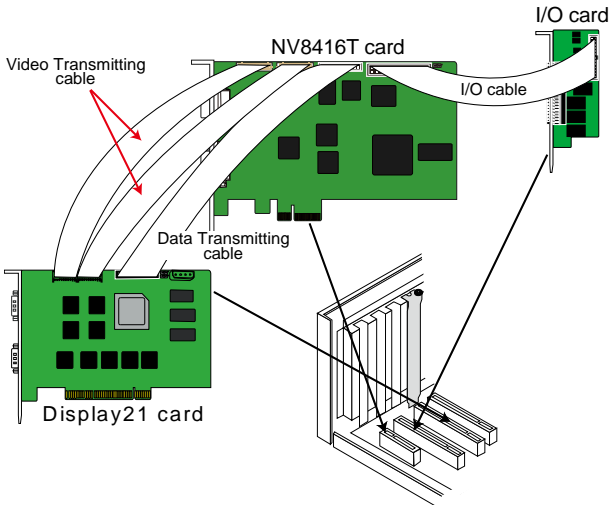

2.9 NV9416T Hardware Installation

2.9.1 Install NV9416T card

1. Remove the PC case cover.
2. Remove 1 bracket that cover the PCI slots and 1 bracket that cover the PCI-Ex1. Save the screws.
3. Connect the Video and Audio transmitting cable to NV9416T card and NV9000E Daughter card.
4. Connect the power cable of power supply inside the PC to power connector of NV9416T card.
5. Press the NV9416T card into the PCI-Ex1 slot and NV9416T Daughter card, into PIC slot firmly.
6. Secure all the cards with the screws.

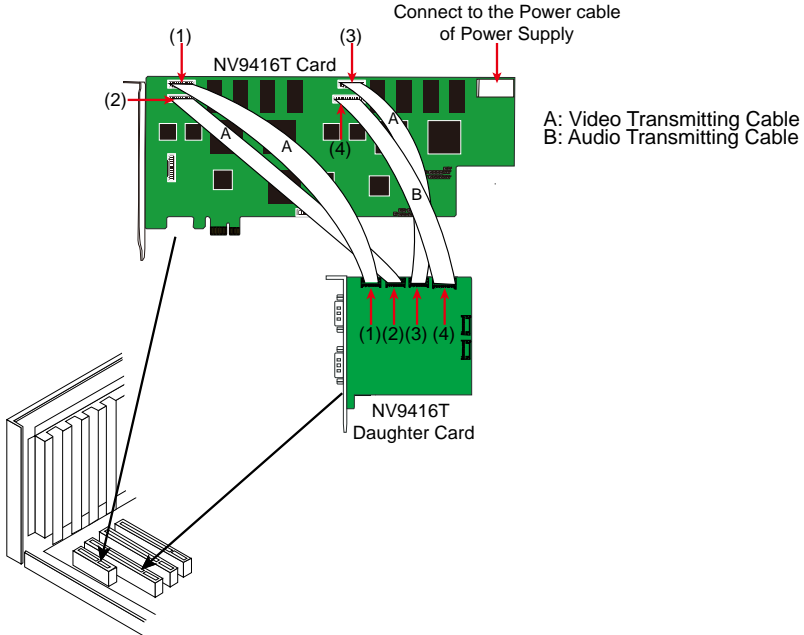

- In illustration, (1) is connecting to (1), (2) is connecting to (2), (3) is connecting to (3), and (4) is connecting to (4).
- All cables connecting position must exactly same as above illustration shown.

2.9.2 Install NV9416T, Display 21 card (optional) and I/O card

1. Remove the PC case cover.
2. Remove 3 brackets that cover the PCI slots and 1 bracket that cover the PCI-Ex1. Save the screws.
3. Connect the Video and Audio transmitting cable to NV9416T card and NV9416T Daughter card.
4. Connect the supplied Data transmitting cable and Video transmitting cable to NV9416T card and Display 21 card. (see figure below for more clear ideal)
5. Connect the I/O card to NV9416T card with I/O cable.
6. Connect the power cable of power supply inside the PC to power connector of NV9416T card.
7. Press the NV9416T card into the PCI-Ex1 slot and NV9416T Daughter card, Display 21 card, and I/O card into PIC slot firmly.
8. Secure all the cards with the screws.

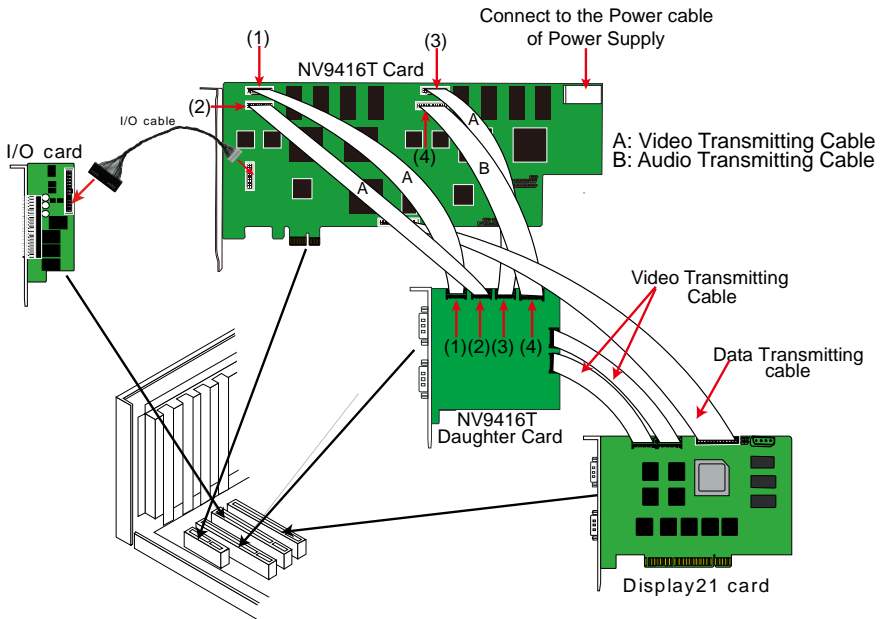

- In illustration, (1) is connecting to (1), (2) is connecting to (2), (3) is connecting to (3), and (4) is connecting to (4).
- All cables connecting position must exactly same as above illustration shown.

2.10 Connecting the Watchdog line

The NV DVR program constantly monitors its operation. Connecting the NV3000T/5000T/6000T/7240/7480/8416T/9416T to the motherboard reset switch panel, enables the unit to restart automatically and reset the system when an error has been detected.



If more than one NV33000T/5000T/6000T/7240/7480/8416T/9416T card is installed, connect the watchdog line at last card.

2.10.1 Connecting the Watchdog line to NV3000T/5000T

1. Look for the labeled RESET SW switch lead and connect it to the NV3000T/5000T card reset pin.
2. Connect the supplied Watchdog line to the NV3000T/5000T card watchdog pin and the other end to the motherboard RESET SW panel. If you are not sure, please refer to the motherboard user manual.
3. You may now replace back the PC cover and connect all the cables.

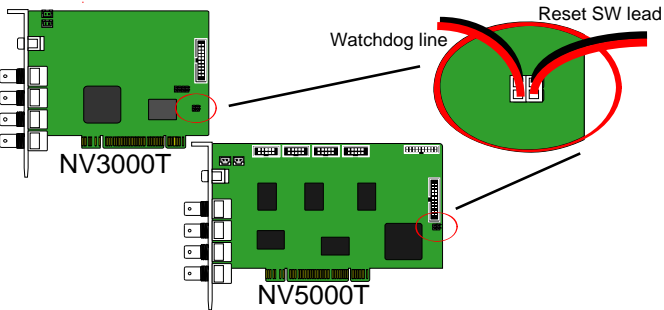

2.10.2 Connecting the Watchdog line to NV6000T

1. Look for the labeled RESET SW switch lead and connect it to the NV6000T card reset pin.
2. Connect the supplied Watchdog line to the NV6000T card watchdog pin and the other end to the motherboard RESET SW panel. If you are not sure, please refer to the motherboard user manual.
3. You may now replace back the PC cover and connect all the cables.

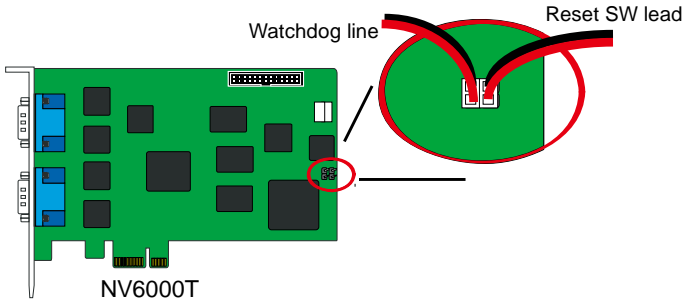

2.10.3 Connecting the Watchdog line to NV7240/NV7480

1. Look for the labeled RESET SW switch lead and connect it to the NV card reset pin.
2. Connect the supplied Watchdog line to the NV card watchdog pin and the other end to the motherboard RESET SW panel. If you are not sure, please refer to the motherboard user manual.
3. You may now replace back the PC cover and connect all the cables.

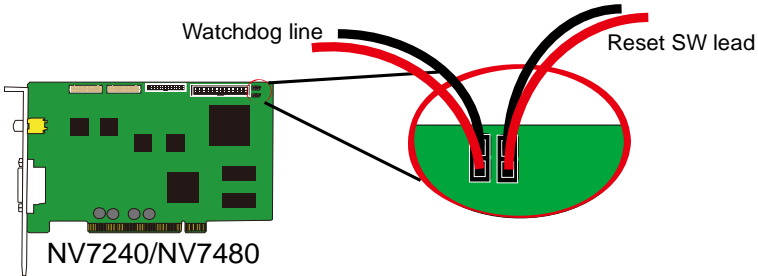

2.10.4 Connecting the Watchdog line to NV8416T

1. Look for the labeled RESET SW switch lead and connect it to the NV8416T card reset pin.
2. Connect the supplied Watchdog line to the NV8416T card watchdog pin and the other end to the motherboard RESET SW panel. If you are not sure, please refer to the motherboard user manual.
3. You may now replace back the PC cover and connect all the cables.

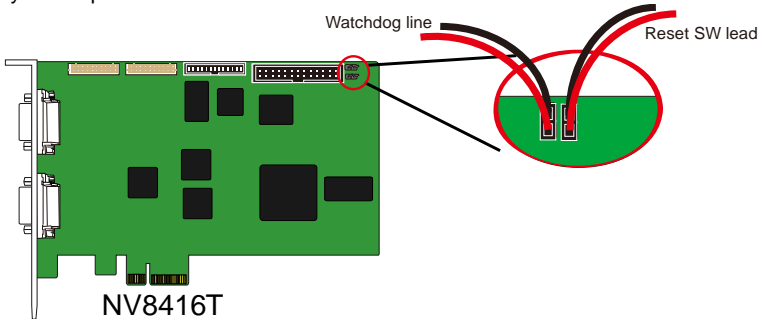

2.10.5 Connecting the Watchdog line to NV9416T

1. Look for the labeled RESET SW switch lead and connect it to the NV9416T card reset pin.
2. Connect the supplied Watchdog line to the NV9416T card watchdog pin and the other end to the motherboard RESET SW panel. If you are not sure, please refer to the motherboard user manual.
3. You may now replace back the PC cover and connect all the cables.

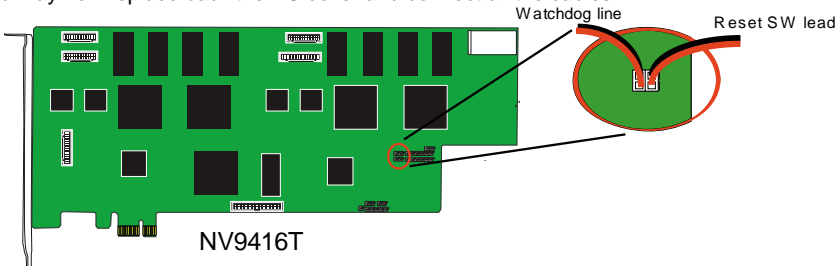

2.11 Connecting the Cameras, a TV and Audio device

2.11.1 Connecting the Cameras, a TV and Audio device to NV3000T/5000T

1. Connect the cameras to the BNC video input port (see [NV3000T/5000T card parts](#)). If you have installed more than one card, please refer the sequence of the camera to the number of cards installed in installing the card section.
2. Connect one end of the RCA video cable (not supplied) to the TV OUT port of NV3000T/5000T card and the other end to the TV video input port. If you are not sure, please refer to the TV user manual.

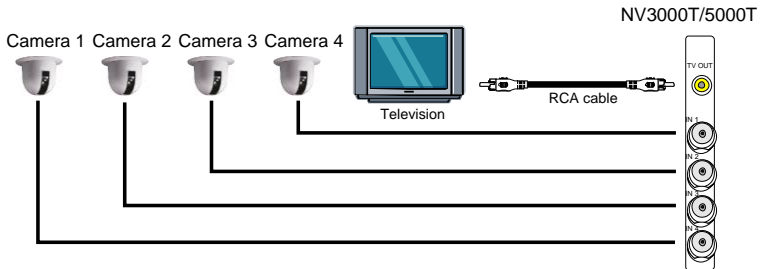

3. Connect the audio devices to the Audio input port of the I/O card.

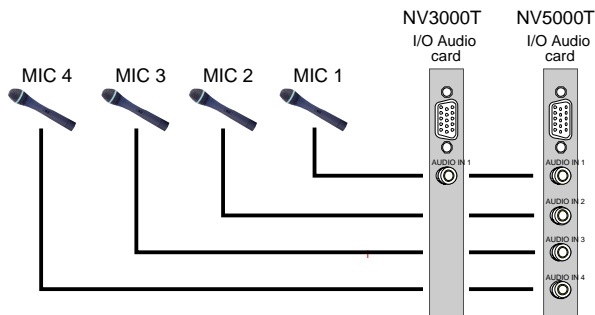

2.11.2 Connecting the Cameras, a TV and Audio devices to NV6000T

1. Use the supplied AV connection cable and connect it to the D-type AV IN port of NV6000T card (see [NV6000T card parts](#)).
2. Connect the cameras to the BNC video connectors and audio devices to the RCA audio connectors. Just follow the order basing on the marked sequence.
3. Connect one end of the RCA video cable (not supplied) to the TV OUT port of NV6000T card and the other end to the TV video input port. If you are not sure, please refer to the TV user manual.

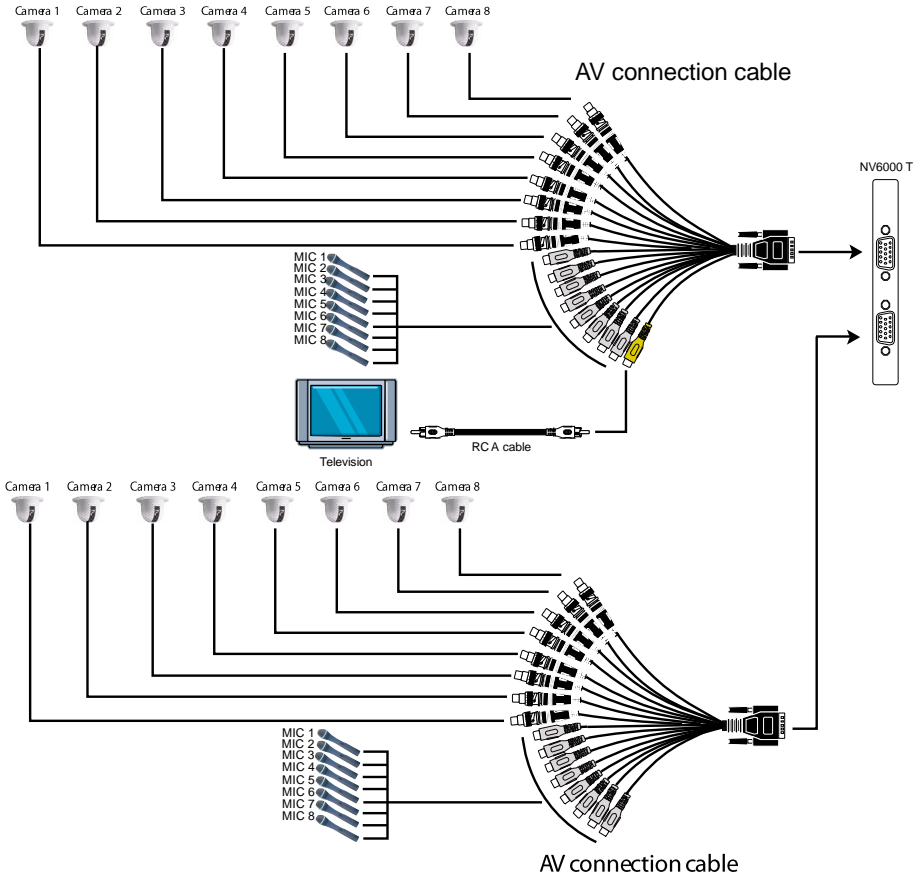

2.11.3 Connecting the Cameras, a TV and Audio devices to NV7240/NV7480

1. Use the supplied AV connection cable and connect it to the D-type AV IN port of NV7480 card (see [NV7240/NV7480 card parts](#)).
2. Connect the cameras to the BNC video connectors and audio devices to the RCA audio connectors. Just follow the order basing on the marked sequence.
3. Connect one end of the RCA video cable (not supplied) to the TV OUT port of NV card and the other end to the TV video input port. If you are not sure, please refer to the TV user manual.

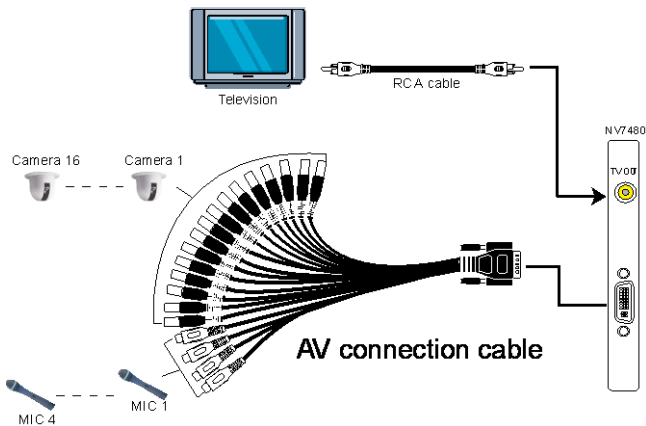
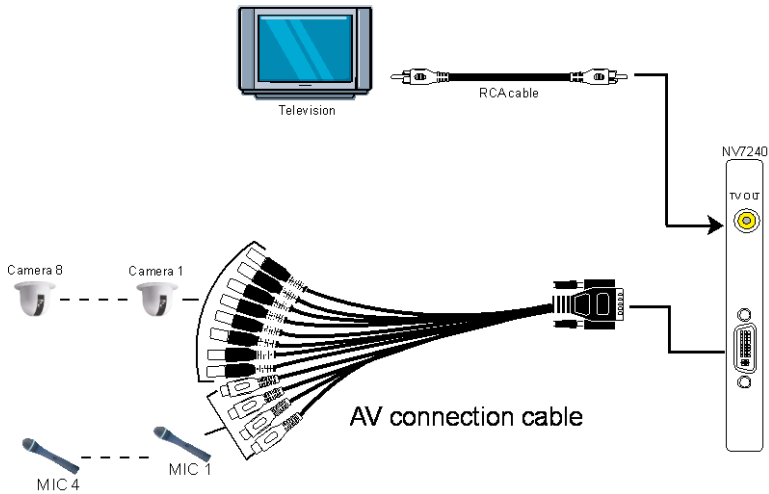

2.11.4 Connecting the Cameras, a LCD Monitor, and Audio devices to NV8416T

1. Use the supplied AV connection cable and connect it to the DVI AV IN port of NV8416T daughter card (see [NV8416T card parts](#)).
2. Connect the cameras to the BNC video connectors and audio devices to the RCA audio connectors. Just follow the order basing on the marked sequence.
3. Connect the LCD Monitor to VGA cable.

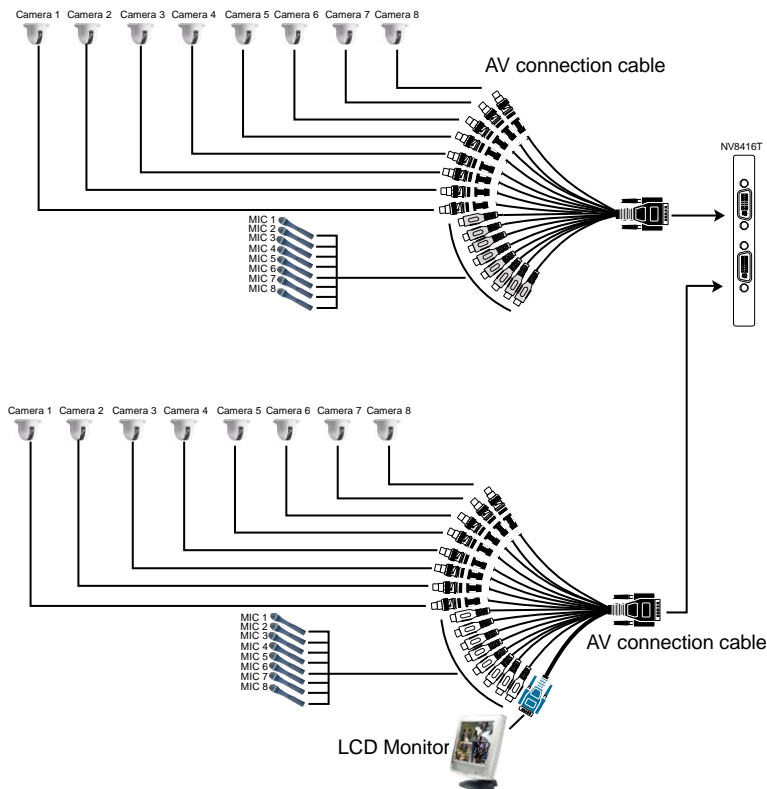

2.11.5 Connecting the Cameras, a TV and Audio devices to NV9416T

1. Use the supplied AV connection cable and connect it to the DVI AV IN port of NV9416T daughter card (see [NV9416T card parts](#)).
2. Connect the cameras to the BNC video connectors and audio devices to the RCA audio connectors. Just follow the order basing on the marked sequence.
3. Connect one end of the RCA video cable (not supplied) to the TV OUT port of NV9416T daughter card and the other end to the TV video input port. If you are not sure, please refer to the TV user manual.

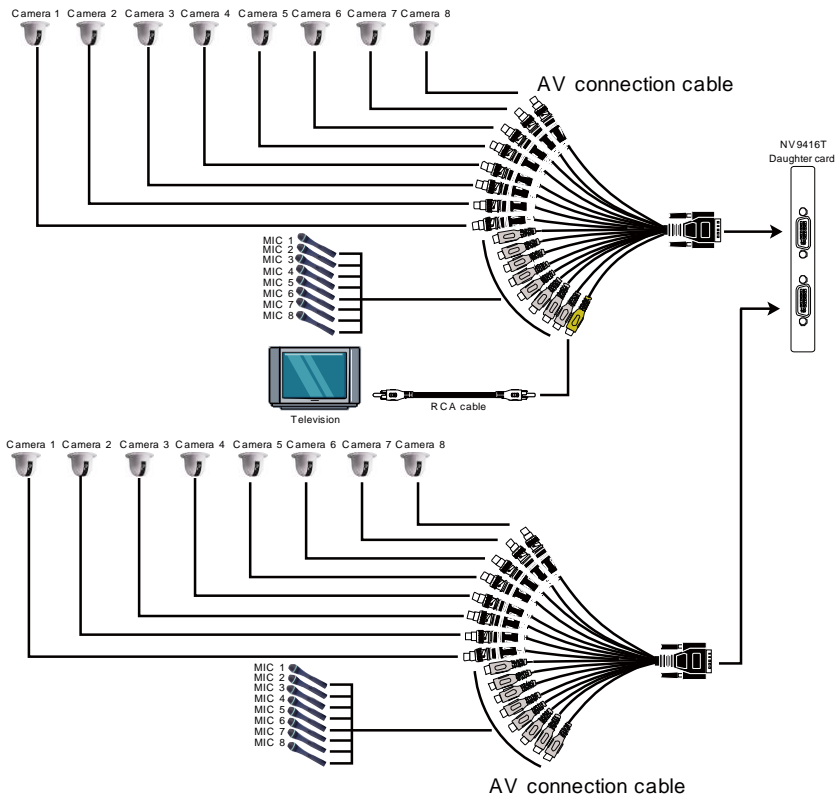

2.12 Dual Monitors Setup

The NV DVR system Supports Single and Dual monitor displays. When using dual monitors, the E-map and Playback function will be display on the second monitor.

The Video configuration is different for each different VGA chipsets. Please follow the steps below to setup the dual monitors display.

2.12.1 Graphic card with ATI chipset

1. Enter the ATI Catalyst Control Center, user can click the short-cut or right click on the screen.



2. There are two modes to select — Basic and Advanced.

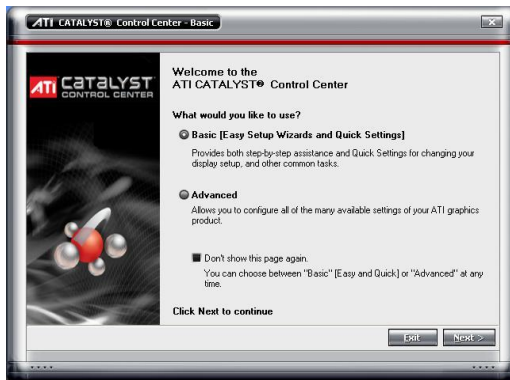

3. If user selected Basic mode, press the **Quick Settings** tab. Then select the **Select a different desktop mode** and click **Go**.

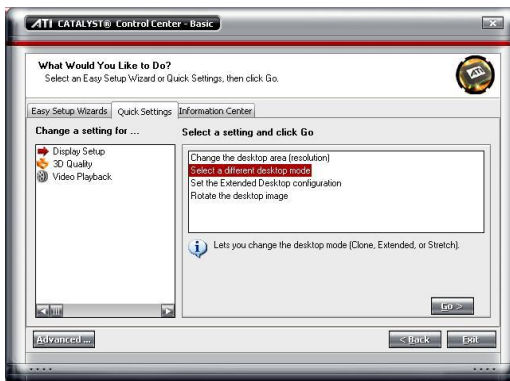

4. Select the **Extended Desktop** and then click **Finish**.

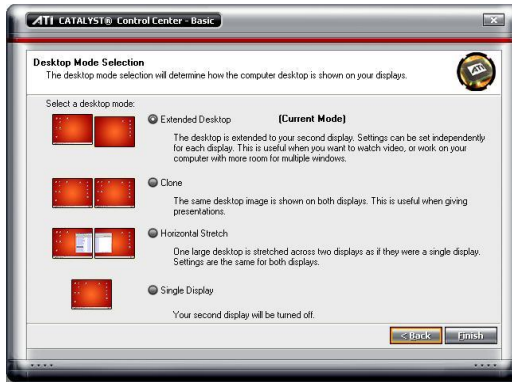

5. If user selected the Advanced mode, click the **View** button.
6. In **Display Manager**, right click on the second Display on the right side and select **Extend Main onto monitor**.



7. Adjust each monitor resolution to 1024x768, 1440x900, 1680x1050, 1920x1200 or 1920x1080.

2.12.2 Graphic card with NVIDIA chipset

1. Click the NVIDIA nView, and select the **Dualview** mode.
2. Adjust each monitor resolution to 1024x768, 1440x900, 1680x1050, 1920x1200 or 1920x1080

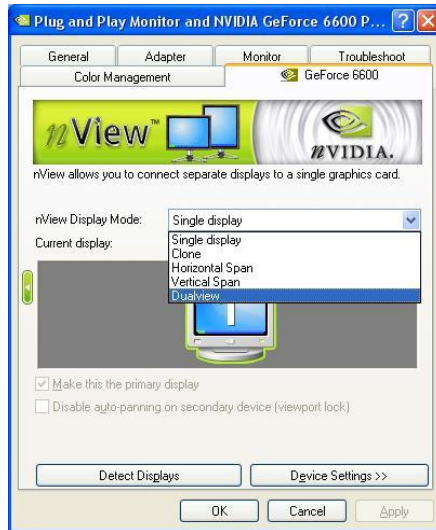

3. To review if the display mode is correct, you can check the task bar. The task bar will show on the first monitor only.



Monitor 1

Monitor 2

2.13 Connecting an I/O box to NV3000T/5000T I/O Audio card



The external I/O box is an optional item. It provides four (4) sensor input and three (3) relay output.

Connect the male end of the D-type cable to the D-type I/O port of the I/O box and the female end to the D-type port of the I/O Audio card. Check the table below and locate which pinhole is assigned to sensor input and relay output.

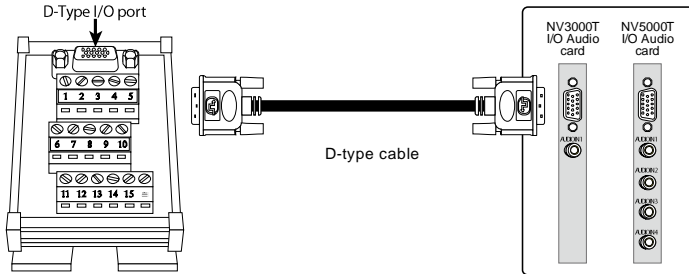

2.13.1 I/O box Sensor and Relay pinhole allocation:

The signal from the sensor (i.e., infrared sensors, smoke detectors, proximity sensors, door sensors, etc.) is being transmitted to the I/O card, and this triggers the system to respond and send signal to relay device (i.e., alarm, telephone etc).

Pin #	Definition
1	INPUT SIGNAL 1+
2	INPUT SIGNAL 2+
3	INPUT SIGNAL 3+
4	INPUT SIGNAL 4+
5	OUTPUT 3 – Normally Closed
6	INPUT SIGNAL 1-(GND)
7	INPUT SIGNAL 2-(GND)
8	INPUT SIGNAL 3-(GND)
9	INPUT SIGNAL 4-(GND)
10	OUTPUT 3 – Common
11	OUTPUT 1 – Normally Open
12	OUTPUT 1 – Common
13	OUTPUT 2 – Normally Open
14	OUTPUT 2 – Common
15	OUTPUT 3 – Normally Open

2.13.2 I/O box pin definition

The following table lists the pin definition of D-type I/O port on I/O box.

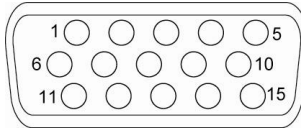

Pin #	Definition	Pin #	Definition
1	Sensor 1	10	Relay 3_COM
2	Sensor 2	11	Relay 1_NO
3	Sensor 3	12	Relay 1_COM
4	Sensor 4	13	Relay 2_NO
5	Relay 3_NC	14	Relay 2_COM
		15	Relay 3_NO

2.14 Connecting the Sensor/Relay device to NV6000T/7240/7480/8416T/9416T I/O card

The I/O Audio card enables you to connect (4) sensor inputs and (4) relay outputs. Just connect the external sensor and relay pin directly to the NV6000T/7240/7480/8416T/9416T I/O card pinhole. Check the table below and locate which pinhole is assigned to sensor input and relay output.

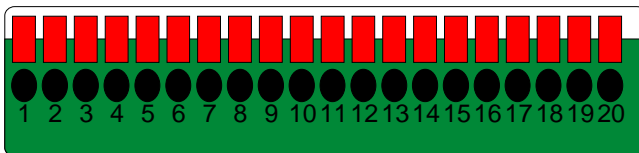

2.14.1 I/O Card Sensor and Relay pinhole allocation:

The signal from the sensor (i.e., infrared sensors, smoke detectors, proximity sensors, door sensors, etc.) is being transmitted to the I/O card and this triggers the system to respond and send signal to relay device (i.e., alarm, telephone etc).

Pin #	Definition	Pin #	Definition
1	Sensor input signal 1+	11	Relay Normal Close 1
2	Sensor output signal 1-(GND)	12	Relay Common 2
3	Sensor input signal 2+	13	Relay Normal Open 2
4	Sensor output signal 2-(GND)	14	Relay Normal Close 2
5	Sensor input signal 3+	15	Relay Common 3
6	Sensor output signal 3-(GND)	16	Relay Normal Open 3
7	Sensor input signal 4+	17	Relay Normal Close 3
8	Sensor output signal 4-(GND)	18	Relay Common 4
9	Relay Common 1	19	Relay Normal Open 4
10	Relay Normal Open 1	20	Relay Normal Close 4

2.15 The Sensor input and Relay output Specifications

You may use the sensor input and relay output specifications table below for your reference.

A. Sensor Input Specification

Absolute Maximum Ratings

(Ta=25°C)

Parameter		Symbol	Rating	Unit
Input	Forward Current	I_F	50	mA
	Reverse Voltage	V_R	6	V
	Power Dissipation	P	70	mW

Electrical/Optical Characteristics

(Ta=25°C)

Parameter		Symbol	Min	Typ.	Max.	Unit	Conditions
Input	Forward Current	V_F	-	1.2	1.4	V	$I_F=20mA$
	Reverse Voltage	I_R	-	-	10	A	$V_R=4V$
	Terminal Capacitance	C_t	-	30	250	pF	$V=0, f=1KHz$
Parameter		Symbol	Min	Typ.	Max.	Unit	Conditions
Output	Collector Dark Current	I_{CEO}	-	-	100	nA	$V_{CE}=20V$
	Collector-Emitter Breakdown Voltage	BV_{CEO}	35	-	-	V	$I_C=0, 1mA$
	Emitter-Collector Breakdown Voltage	BV_{ECO}	6	-	-	V	$I_E=10 A$
Transfer Characteristics	*Current Transfer Ratio	CTR	50	-	600	%	$I_F=5mA, V_{CE}=5V, R_{BE}=\text{---}$
	Collector Current	I_C	2.5	-	30	mA	
	Collector-Emitter Breakdown Voltage	$V_{CE(sat)}$	-	0.1	0.2	V	$I_F=20mA, I_C=1mA$
	Isolation Resistance	R_{ISO}	5×10^{10}	10^{11}	-		DC500V, 40-60% R.H.
	Floating Capacitance	C_f	-	0.6	1.0	pF	$V=0, f=1MHz$
	Cut-off Frequency	f_c	-	80		KHz	$V_{CE}=5V, I_C=2mA$ $R_L=100, -3dB$
	Response Time (Rise)	t_r	-	4	18	s	$V_{CE}=2V, I_C=2mA$ $R_L=100$
Response Time (Fall)	t_f	-	3	18	s		

$$*CTR = \frac{I_C}{I_F} \times 100\%$$

B. Relay Output Specification

Surge strength	:1500 VAC
Nominal power	: 200mw ~ 360mw
Operating power	: 110mw ~ 200mw

C. COIL RATINGS (at 20 oC)

Coil Nominal Voltage (VDC)	Coil Resistance 10%	Pick-up Voltage (VDC)	Drop-Out Voltage (VDC)	Nominal Current (mA)
5	125	3.75	0.5	40

* Max Continuous Voltage at 20°C : 110% of Coil Nominal Voltage

D. CONTACT RATINGS

Contact Arrangement	1 Form C (SPDT)
max. Switch Power	125VA 60W
max. Switch voltage	125VAC 30VDC
max. Switch current	1A
Contact Resistance	$\leq 100m\Omega$
Resistive Load	1A/125VAC 1A/30VDC

2.16 Connecting POS (Point of Sales)

AVerMedia® AVerDVR can be integrated with POS system equipment. Connecting the POS equipment to AVerMedia® AVerDVR system thru RS232 connection, enables you to view, record and keep track of the items that were sold. You may also select the camera on where to display all the data.

To connect, locate the RS232 port of the POS equipment and PC. Use an RS232 cable (not supplied) to make the connection.

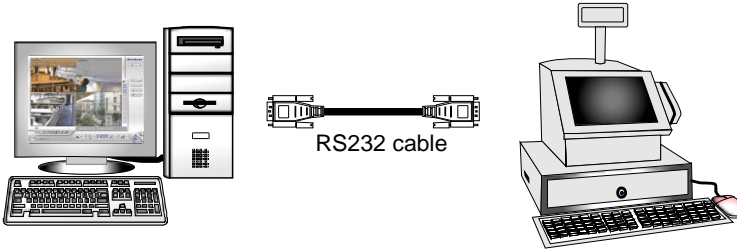

For detail of POS installation, please refer to POS Quick Guide.

Chapter 3 Software Installation

This chapter describes how to install the NV DVR software and drivers.



The CD-Key is permitted for use on a single computer. It is prohibited to use the CD-key on more than one computer. Once detected, this would cause a system conflict and some of the features might fail to work on both PC.



Before installing the software, make sure that the Windows OS patches and the video graphic card driver are **UPDATED**.



If you have an old version of the NV DVR software installed in your PC, the old copy must be removed. To remove, click **Start>Settings>Control Panel** and then double click **Add/Remove Programs**. In Add/Remove Programs list, select **NV DVR** and then click **Remove**.



We **HIGHLY RECOMMEND** having three (3) separate drives for the main system (OS and NV DVR software), storage and backup. The ideal hard disk size for the main drive is 20GB. As for the storage and backup, at least 60GB each. The hard drives format must be in **NTFS**. This way we can maintain an optimized system for your security.



To ensure getting the latest copy of NV DVR software, go and download the updated version from the following site:

Worldwide :

<http://www.avermedia.com/AVerDiGi/support/Default.aspx?Pid=1>

US/CANADA:

<http://www.avermedia-usa.com/surveillance/support.aspx>

3.1 Installing NV DVR Software and Drivers in Windows XP/Vista/7



Upon turning the computer on, the system automatically detects the newly installed hardware. When the **Found New Hardware** dialog box appears, **IGNORE** it.

Remember : It is important to install the NV DVR software first, before installing the drivers.

Please follow the below steps to install NV application:

1. Place the installation CD into the CD-ROM drive then click **Install Surveillance System**. And follow the on-screen instructions.



2. When product select dialog appears, mark the NV card that you have purchased. The NV7240 and 7480 is belonging to NV7000 series.
3. Accept the agreement license to continue the installation. If you do not agree the license agreement, the installation will be cancel.
4. Enter your company name and the series number that is located on the cover of installation CD.
5. Click **OK** to complete the installation.
6. You may now run the NV DVR program. To run the application, click  on your PC desktop or click **Start > Programs > DVR > NV series**.

Chapter 4 Using the NV DVR Software

4.1 Running the NV DVR Software

To run the application, double-click  on your PC desktop or click **Start > Programs > DVR > NV series**. Also, **Start > NV series**.

For security purpose, some of the features would require you to enter User ID and Password before it can be accessed. When the Authorization dialog box appears, key in your User ID and Password. (If this is the first time, enter the one you have registered when installing the software.)



Please make sure the cursor is located on User ID or Password column if user has call out virtual keyboard for entering ID and password.



4.2 Using the Virtual Keyboard

If the keyboard is not available, you may use the Virtual Keyboard. Just click  to show the virtual keyboard. For uppercase and lowercase, click **shift** button.



4.3 Familiarizing the Buttons in Preview/Advanced Mode

NV DVR now supports 1024x768, 1440x900, 1680x1050, 1920x1200 or 1920x1080 display resolution.



(20)



Name**Function**

(1) Exit

Call up the Logout dialog box.

In the logout dialog box, you may do the following:

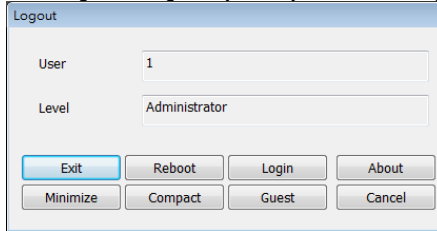

- Click **Exit** to close the NV DVR program.
- Click **Reboot** to restart DVR system.
- Click **Login** to sign-in in different account.
- Click **About** to update patch or find about the software info.

To update the patch file, Click **Update** and select the patch file location – **Local Machine** or **Server Download**. And then, select **Update type – Main program** or **IP camera**.

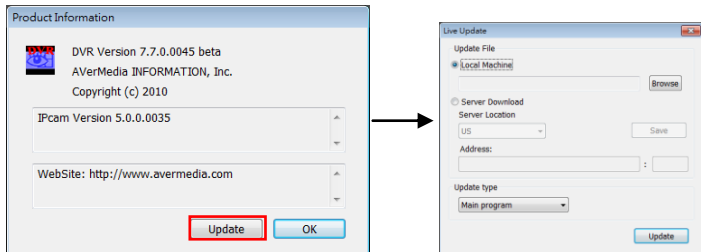

- Click **Minimize** to reduce the NV DVR to taskbar button.
- Click **Compact** to switch to compact mode (see [Chapter 4.4](#)).
- Click **Guest** to switch to the guest mode. In guest mode, the functions are limited to preview function only. For complete functions of DVR, please login as an administrator.
- Click **Cancel** to exit Logout dialog box.

(2) Volume





Adjust the sound volume.

(3) Split Screen Mode

Select from 7 different split screen types to view all the camera, or one camera over the other or alongside on a single screen. It also allows you to switch and view different camera number.

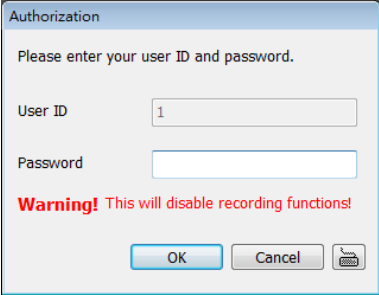

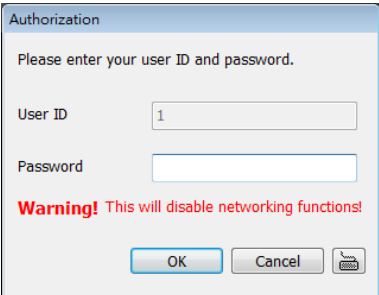
- If there are only 4 cameras, you won't be able to switch to 9, 16, 13, and 32 split screen mode.
- The DVR system will save the current operating mode (split screen mode, auto scan, full screen, and compact mode status) when shutdown DVR application and apply the mode status for next login.
- When you are in single screen mode, **Right-click** and **Drag** a square on the area you want to enlarge. Using left button of mouse click on the enlarge screen area and user can move the screen for viewing. Right-click on screen again will back to normal view.
- When you are in multiple-screen mode, **Right click** the video screen of the camera and **Drag** on where you want to relocate it. To only display one of the video in the multiple-screen mode, **Left click** on the video screen you only want to display.

Name	Function
(4) Record	<p>Start/stop video recording. The authorize password is required for disabling the record function. The authorization dialog will show the warning message to inform the user for stop recording.</p> 
<p> Please make sure the cursor is located on Password column if user has call out virtual keyboard for entering ID and password.</p>	
(5) Emap	<p>Display the map in each area, and the location of camera/ sensor/ relay and the warning(see also Chapter 4.7).</p>
(6) Network	<p>Enable/disable remote system access. This feature allows you to access NV DVR server from a remote location via internet connection (see also Chapter 8). The authorize password is required for disabling the network function. The authorization dialog will show the warning message to inform the user for disabling network.</p> 
<p> Please make sure the cursor is located on or Password column if user has call out virtual keyboard for entering ID and password.</p>	
(7) Setup	<p>Configure the system settings (see also Chapter 5).</p>
(8) PTZ	<p>Access PTZ control panel. Beside PTZ camera, NV DVR system also support mega pixel IP PTZ camera (see also Chapter 4.6).</p>
(9) Preview	<p>Switch to Preview/Advanced mode. This allows you to view live camera display. Press ctrl + F can freeze the live preview video screen. And then, click Snapshot can save the freeze video screen.</p>
(10) Playback	<p>Switch to Playback mode. This allows you to view the recorded video file(see Chapter 4.5).</p>
(11) Status Bar	<p>Display the current date, time and hard disk free space.</p>

Name	Function
------	----------

(12) Camera Group Tree	To view the user defined channel group tree(see also Chapter 5.2.4). Click + of group to extend group and drag the camera to surveillance screen to view. Click + of camera to view the camera information.
------------------------	--



(13) Camera ID	Show the number of cameras that are being viewed. When you are in single screen mode, click the camera ID number to switch and view other camera.
----------------	---

Name	Function
------	----------

(14) iPOS Live

To view the real time iPOS data of channels. Click the iPOS Live to call out the real time iPOS data windows.

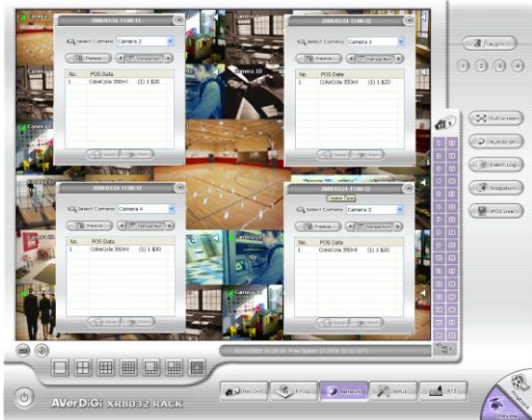

User can move the channel of iPOS windows apart to proper position. If user didn't enable the multi-channel of iPOS Live(see also [POS Advanced Setting](#) in 5.1.1), and then, user only can view one channel each time.



To switch to different channel, click **Select Camera** drop down list to select the channel. To tempore stop iPOS data coming, click **Freeze**. To un-freeze, click **Transaction**.

(15) Snapshot

Capture and save the screen shot either in *.jpg or *.bmp format.

(16) Event log

Show the record of activities that take place in the system (also see [Chapter 4.3.1](#)).

(17) AutoScan

Start/Stop video screen cycle switch (see also [Chapter5.1 #6](#)).

Name**Function**

(18) Full screen

Use the entire area of the screen to only display the video. To return, press the right button of the mouse or **ESC** on the keyboard or click the arrow icon.

When DVR in full screen mode, each channel will display current date and time.





When you switch to full screen in multiple-screen mode, Left click to toggle to only display one of the video in the multiple-screen mode or all.

(19) Alarm

Alert and display warning info. Only Administrator-level can reset and turn on, off and trigger the Sensor and Relay by right-clicking the item in the Sensor and Relay list.

Name	Function
------	----------

(20) Live Playback button

Click  to playback the recorded file instantly in preview mode. When the channel is in live playback mode, the icon is . Move the mouse to the bottom of the live playback channel, the playback tool bar  will show up. Using the playback tool bar to control the playback. Total 4 channels can be live playback at the same time.

 When DVR system start to recording, the live playback button will appear on the screen of each channel.



9-split screen mode



Single screen mode

(21) On Screen Keyboard

If the keyboard is not available, you may use the Virtual Keyboard.

4.3.1 Using Event Log Viewer

Show the record of activities that take place in the system.



- NV DVR system now supports HDD failure pre-detection mechanism called **HDD S.M.A.R.T.** function. Once when DVR system has detected the HDD failure possibility, an event log will be occurred and user can check it in Event Log Viewer window.
- The HDD S.M.A.R.T. function accurate is approximately about **60%**.
- The HDD warning event log will issue once a day.

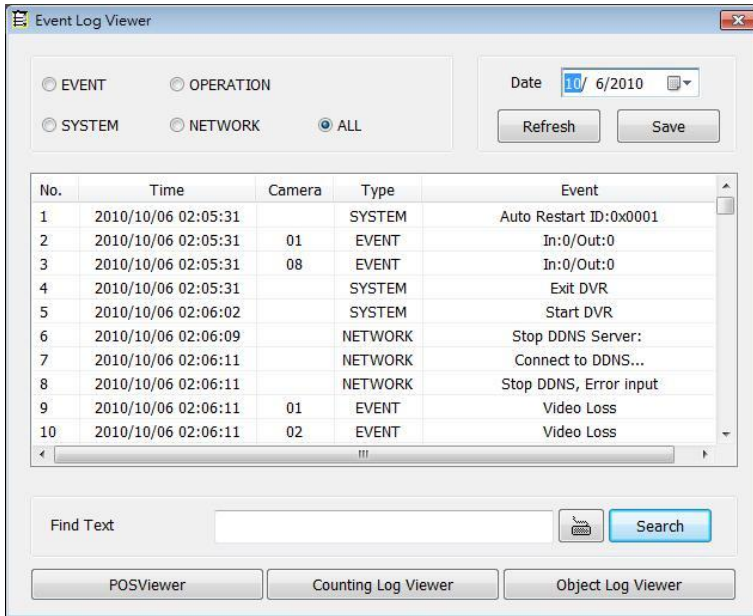

HDD S.M.A.R.T. warning messages' description are as following:

- **HDD warning (Low risk):** abnormal situations are occurred frequently but hard disk can recovery by itself.
- **HDD warning(High risk):** When HDD warning(Low risk) event has occurred too frequently, even though hard disk can recovery by itself; however hard disk recovery too frequently will effect performance of hard disk. Therefore, it is recommended to replace the hard disk.

[Note] HDD S.M.A.R.T. is an accumulation mechanism, therefore the HDD warning (High risk) event log will issue once every day until hard disk has been replaced.

1. Click the Event Log button on DVR application main interface. The Event log viewer window will show up.
2. Select the **Date** to view or search certain event log by key word. Enter the key word in **Find Text** column and click **Search** button.
3. To filter the records, select and click the select button to display Event, System, Operation, Network or All.
4. The events list which display on the screen can be saved as text file format. To save the events list,

- click **Save** button.
- To view POS event log, click **POSViewer** bar to call out the POSViewer window (see also [Using POS Viewer](#)).
 - Click Counting Log Viewer to view object counting information (see also [Using Counting Log Viewer](#)).
 - To view FaceFinder log, click Object Log Viewer (see also [Using Object Log Viewer](#)).

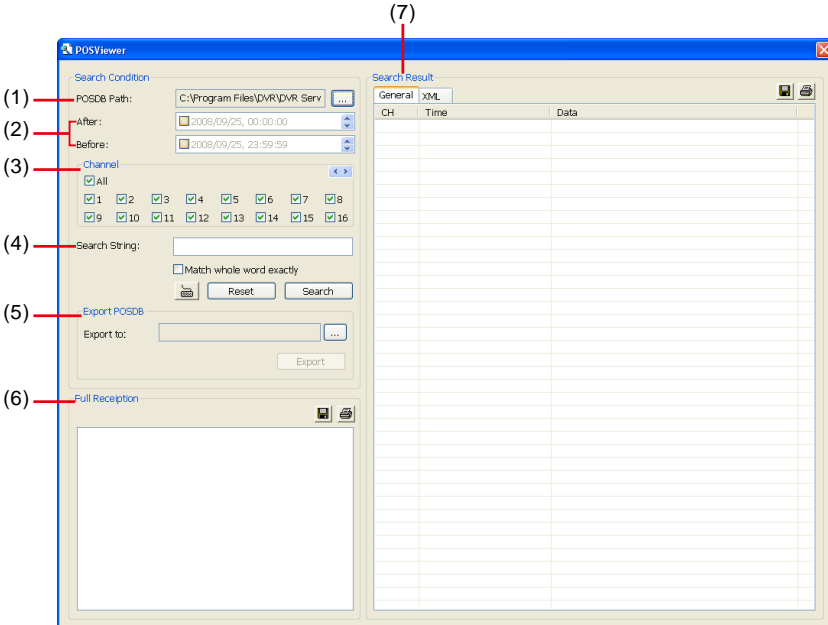

Using POS Viewer

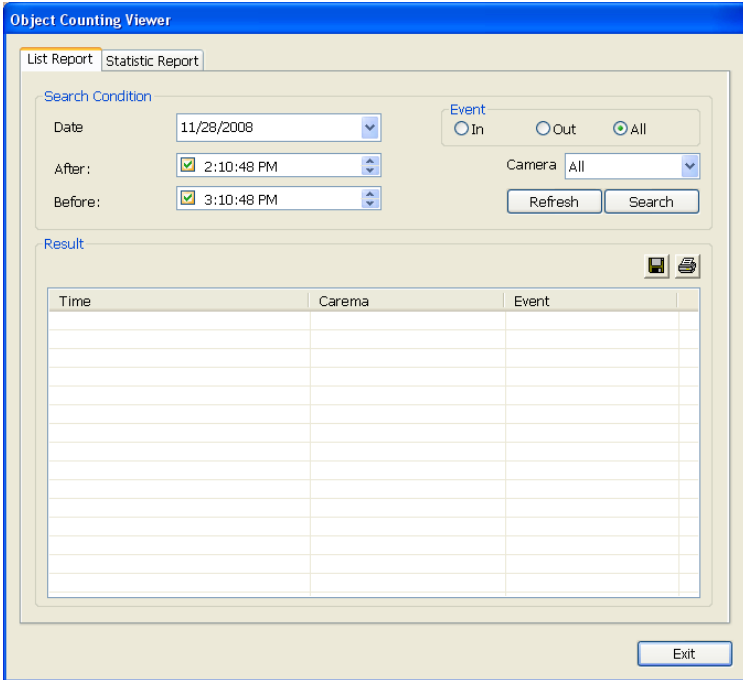

Name	Function
(1) POSDB Path	The storage path for POS event log. Click to change the storage path.
(2) Before/After	Set a time period before and after of POS event log.
(3) Channel	Select the POS event log of channel
(4) Search String	Enter specific key word or word string to search the POS event log. Mark the Match whole word exactly box if wants to find exactly key word or word string of POS event log.
(5)Export POSDB	It allows user to save the POS database to selected storage path in excel format. Click to change the storage path. Click Export to save the POSDB to selected storage path.
(6) Full Reception	Display the POS event log detail that user selected from Search Result window. Click to save the POS event log. Click to print out the POS event log.
(7) Search Result	Display the POS event log of search result. Click to save the search result. Click to print out the search result.

Using Counting Log Viewer



1. Select the **Date** and set a time period between **After** and **Before** for object counts searching.
2. Select the search **Event – In, Out or All.**
3. Select the **Camera** or **All** cameras to search.
4. Click **Search** to start searching.
5. The result will be list out in **Result** tablet.
6. To save the search result, click .
7. Click  to print out the object counts log.
8. To view the analysis of object counts, click **Statistic Report** tab.

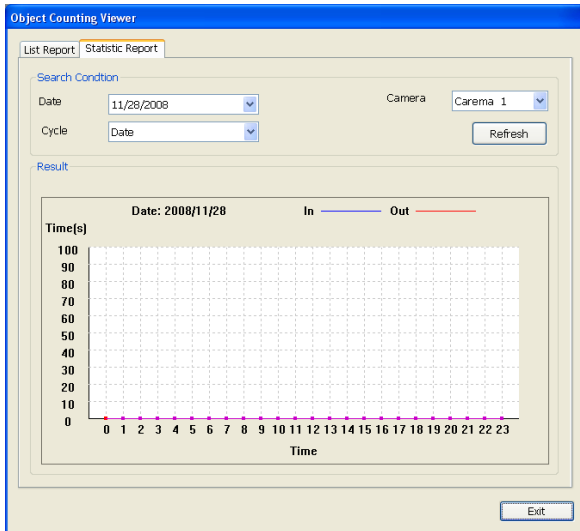

9. User can select the **Date**, **Camera**, and **Cycle** to view the report of object counts (In/Out).

Using the Object Log Viewer

Click Object Viewer bar to view and search FaceFinder event log.

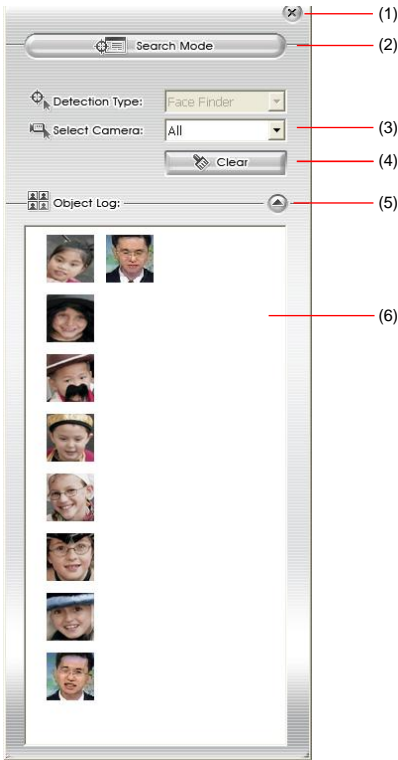

Name	Function
(2) Search Mode	Switch to face object log search mode. In search mode UI, select the Time and Camera to search the object. Click Print button can print out the search result.

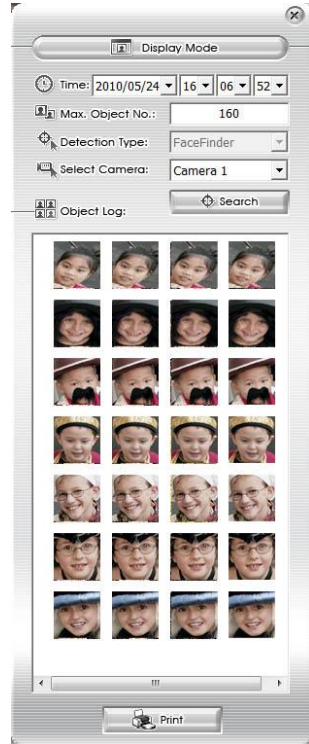

(3) Select Camera	Select the camera to view or select all to view all cameras
(4) Clear	To clear all object log in Object Log list
(5) Close up	Click to close up the Object Log List
(6) Object Log List	Display the face object logs. It can display 32 object logs and when the list is full, the first row of object log will be replaced.

4.4 Familiarizing the Buttons in Compact Mode

To view in Compact mode, click **Exit** button. In the logout dialog box, click **Compact**.

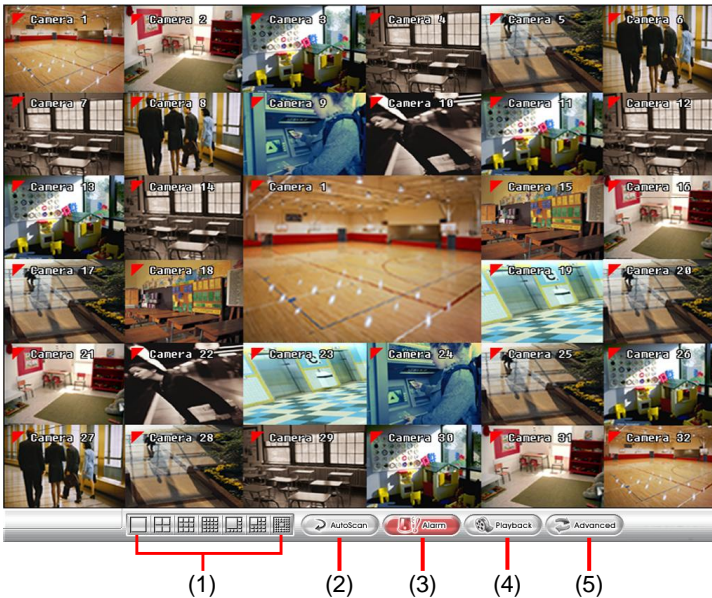
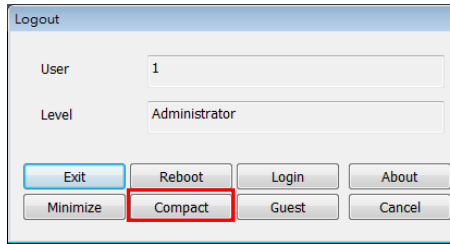

Name	Function
(1) Split Screen Mode	Select from 7 different split screen type to view all the camera, or one camera over the other or alongside on a single screen.
i	<ul style="list-style-type: none"> - If there are only 4 cameras, you won't be able to switch to 9, 16, 13, and 32 split screen mode. - When you are in single screen mode, Right click and Drag a square on the area you want to enlarge. - When you are in multiple-screen mode, Right click the video screen of the camera and Drag on where you want to locate it. To only display one of the video in the multiple-screen mode, Left click the video screen you want to display.
(2) AutoScan	Start/Stop video screen cycle switch
(3) Alarm	Alert and display warning info.
(4) Playback	Switch to Playback mode. This allows you to view the recorded video file. (see Chapter 4.5)
(5) Advanced	Switch to Preview/Advanced mode.

4.5 Familiarizing the Buttons in Playback Mode

To switch in Playback mode, click **Playback** button at the lower right corner of Advanced/Preview mode user interface.



In wide screen mode, click ◀ button call out the progress bar. According to color of progress bar, user can know the recording file type. Blue means regular recording file. Green means motion recording file. Yellow means video loss while recording.

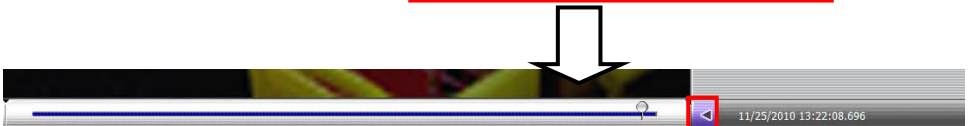



Name	Function
------	----------

(1) Split Screen Mode	Select from 6 different split screen type to playback the recorded video file of all the camera, or one camera over the other or alongside on a single screen.
-----------------------	--



- If there are only 4 cameras enabled, you won't be able to switch to 9, 16, and 13 split screen mode.
- To zoom in an area on the screen, **Right-click** and **Drag** a square on the area you want to enlarge. Using left button of mouse click on the enlarge screen area and user can move the screen for viewing. Right-click on screen again will back to normal view.

(2) Exit	Close the Playback application.
----------	---------------------------------

(3) Progress bar	Show the progress of the file being played. You may move the bar to seek at any location of the track.
------------------	--

(4) Hour Buttons	Select and click to playback the recorded video file on the specific time frame.
------------------	--



The Hour buttons represent the time in 24-hour clock. The blue bar on top of the hour button indicates that there is a recorded video file on that period of time. While the red bar indicates that you are currently viewing the recorded video file.

(5) Playback Control Buttons	<p>Begin: Move at the beginning of the recorded video file.</p> <p>Previous: Go back to the previous frame.</p> <p>Slower: Play the recorded video file at the speed of 1/2X, 1/4X, 1/8X, 1/16X, or 1/32X.</p> <p>Rewind: Wind back the recorded video file.</p> <p>Pause: Briefly stop playing the recorded video file.</p> <p>Play: Play the recorded video file.</p> <p>Faster: Play the recorded video file at the speed of 2x, 4x, 8x, 16x or 32x.</p> <p>Next: Go to the next frame.</p> <p>End: Go to the end of the recorded video file.</p>
------------------------------	---

Name**Function**

While faster play status, press **play** button, then, the play speed will back to normal playback speed (1x).

(6) Archive

Select the date on the calendar and the time from 00 to 23 to where to start playing the recorded video file.

- **OPEN FILE:** user can open the recorded file from HDD
- **Channel 01~ 16&Channel 17 ~ 32:** Switch to different channel group of playback calendar.
- **Day Light Saving:** the playback calendar will show the available video records during day light saving time period.

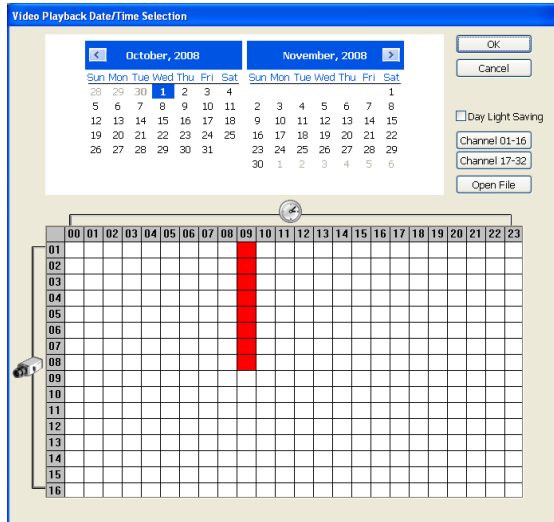

The numbers from 00 to 23 represent the time in 24-hour clock. The numbers from 01 to 16 represent the camera ID. The blue colored column indicates that there is a recorded video file on that period of time. While the red colored column indicates on where to start playing the recorded video file.

(7) Status bar

Display the recorded date, time and play speed.

(8) Camera ID

Show the number of cameras that are being viewed. When you are in single screen mode, click the camera ID number to switch and view other camera.

Name**Function**

(9) iPOS Search

To find iPOS event by keyword or period.

POSOB Path: where the iPOS data located.**Start Time:** select the search start time and date**End Time:** select the search end time and date**Select Camera:** select the camera for iPOS events search**Keyword:** enter a keyword to search iPOS event

- **Match whole words exactly:** the iPOS event must 100% match the keyword that user has entered.

The search result will display in Search Result windows. User can click specific iPOS event to view and the iPOS detail will display in Search Receipt.

To save the search result, click **Save** button. Click **Print** button to print the search result.

To save the selected iPOS search receipt, click **Save**. Click **Print** to print the selected iPOS event's detail.

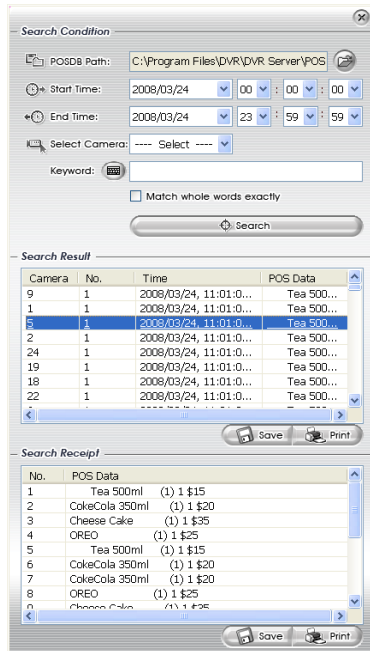

(10) Export

Export includes Snapshot, Print, Output Video Clip, and Backup function.

- **Snapshot:** Capture and save the screen shot either in *.jpg or *.bmp format.
- **Print:** Print the screen shot.
- **Output Video Clip:** Save the segmented file in *.mpg, *.avi, or *.dvr format (see also [Chapter 4.8](#)).
- **Backup:** Save the playback file to USB device or DVD-ROM disk(see also [Chapter 5.6 Backup Setting](#))

Name	Function
------	----------

(11) Segment	Keep a portion of the recorded video (see also Chapter 4.8).
--------------	---

(12) Full screen	View in Playback-compact mode. To return, press the right button of the mouse or ESC on the keyboard or click the arrow icon.
------------------	--



When you switch to full screen in multiple-screen mode, **Left** click to toggle to only display one of the video in the multiple-screen mode or all.

i	When there are dual monitors with 32 channels, the full screen mode will split into 16 channels on each monitor.
----------	--

(13) Event log	Show the record of activities that take place in the system. To filter the records, select and click the option button to only display Event, System, Operation, Network or POS.
----------------	--

(14) Bookmark	Mark a reference point when previewing the recorded video file to which you may return for later reference. You may also set it to protect the file. (See also Chapter 4.9)
---------------	--

(15) Visual Search	Search from a specific camera by Date, Hour, Minute, 10 Seconds and Second. (See also Chapter 4.10)
--------------------	--

(16) Find Next	Search for the next event or changes in the motion detector frame. You can use this when you are using Intelligent Search or Event Search function.
----------------	---

(17) Event Search	Search from the recorded activities that take place in the system (i.e., Sensor, Motion, Video Loss, POS). (See also Chapter 4.11)
-------------------	---

(18) Intelligent Search	Search the changes in the motion detector frame (See also Chapter 4.12).
-------------------------	---

(19) Audio	Enable/disable volume. To adjust audio volume, drag and move the audio volume bar beside the audio button.
------------	--

(20) De-interlace	To enhance the video quality. Set the de-interlace mode to #1, if you are capturing motionless picture and #2, if it captures lots of movement.
-------------------	---

i	IP camera doesn't support de-interlace.
----------	---

(21) Watermark	To verify the playback video has not been modified (also see Chapter 4.5.1).
----------------	---

4.6 Watermark Verification

Now, NV DVR supports watermark-checking to identify the authenticity of playback video. NV DVR program can only verify one channel at a time in playback mode.



To verify the playback video doesn't been modified. Click  to check the video. Watermark verification windows will show up as following:

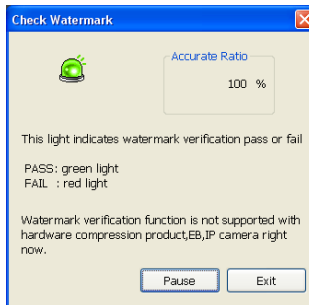

Watermark verification doesn't support the video that is recorded from IP camera.

4.7 Familiarizing the Buttons in PTZ Camera Controller

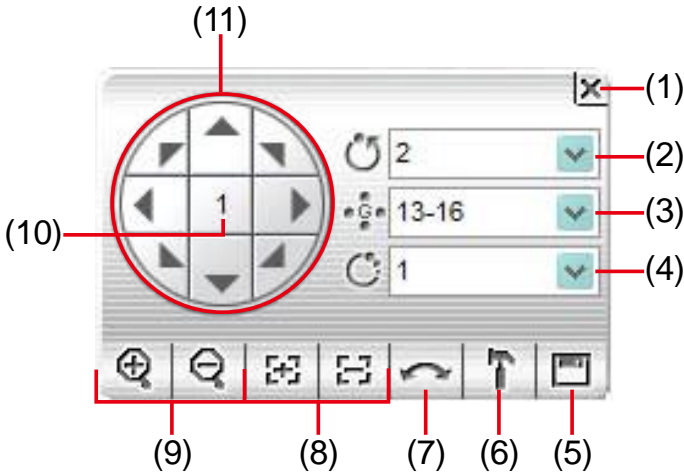

Name	Function
(1) Close	Exit PTZ camera controller.
(2) Camera preset position number	Move the PTZ camera to the preset point.
(3) Group AutoPan	Select to automatically operate PTZ camera in group.
(4) Direction buttons' moving speed	Adjust the moving speed of the PTZ camera lens. This speed will apply to the (11) Direction buttons' moving speed only.
(5) Save Camera preset position	Save the PTZ camera preset position number. Select the camera and click the preset position number and save it.
(6) Setup	Configure PTZ cameras (also see Chapter 4.13).
(7) AutoPan	Operate the PTZ cameras automatically based on the selected camera group preset position number.
(8) Zoom +/-	Zoom in and out the image.
(9) Focus +/-	Adjust the focus manually to produce clear image.
(10) Camera ID	Display the PTZ camera number that is being operated.
(11) Direction buttons	Move and position the focal point of the PTZ camera. The support of direction button depends on the PTZ camera.

4.8 Setting Up and Using the Emap

E-Map can hold up to 8 maps in *.bmp/*.jpg format. You may locate the camera, sensor and relay on the map.

To Set Up the Emap

1. Click **Emap**.
2. When the Emap screen appears, click the area number (1 to 8 buttons) on where you want to insert the map.
3. Click **Load Map** to insert the map. When the open dialog box appears, locate and select the map and click **Open**.



The DVR only supports 24-bit and 32-bit bmp and jpeg file.

The map file size is no more than 200K.

4. When the inserted map appears on the Emap screen, click **Edit**. You may now drag the camera, sensor, and relay icons to its place on the map. Icons on the map can be relocated anywhere.
5. To set the camera direction, right click camera icon can select the camera direction in 8 angles.
6. If you are going to locate the icon on the map to other area, you need to drag the icon to the black pane at the bottom of the Emap screen and then switch to the area on where you want to locate the icon. To bring all the icons back to the black pane at the bottom of the Emap screen, click **Reset Icon**.

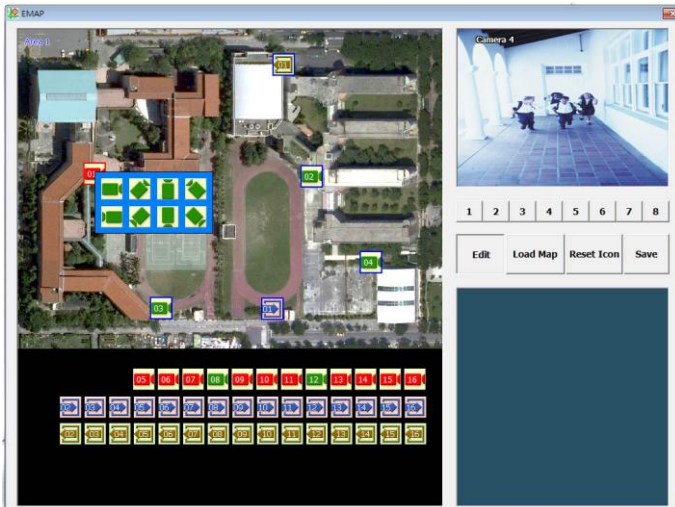

7. When you are done, click **Save** button to save the new setting. To close Emap screen, click **X**.

4.8.1 To Use the Emap

1. Click **E-map**.
2. In the Emap screen, click the camera icon to switch on the area where the camera is located on the map and to display the video at the upper right corner of the Emap screen. At the lower right corner of the Emap screen, it lists all the warning message.

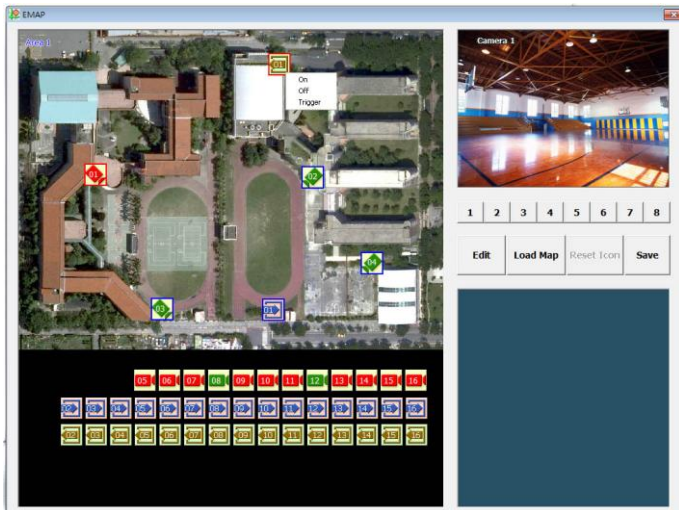

3. To control relay, right-click relay icon and select status (on, off, or trigger) of relay.
4. To view different Emap, click Emap number button (1 ~ 8).
5. Click **X** to close Emap screen.

4.9 To Cut and Save the Wanted Portion of the Recorded Video

1. Use the Playback Control buttons or drag the bar on the playback progress bar and pause on where you want to start the cut. Then, click **Segment** to set the begin mark.



2. Use the Playback Control buttons or drag the bar on the playback progress bar and pause on where you want to end the cut. Then, click **Segment** to set the end mark. To cancel segmentation or set the segment marks from the start, click **Segment** button again.



3. Click **Export** → **Output Video Clip** button to save the wanted clip.
4. In the Save As dialog box, locate on where you want to save the file or choose to **Burn** the video segment to VCD/DVD ROM (only for *.mpeg file format).
5. Select the file type and mark “**show camera information**” to display the camera name, recording date, and time won’t be shown on screen when playback.
6. If the select the file type is *.avi, user can mark **included audio** to include audio in output video segment.
7. To adjust **Video Quality** if needed.
8. Click **Save** to save the video segment.



- MPGE format doesn't support audio output.
- Right-click function is disabling for security issue.

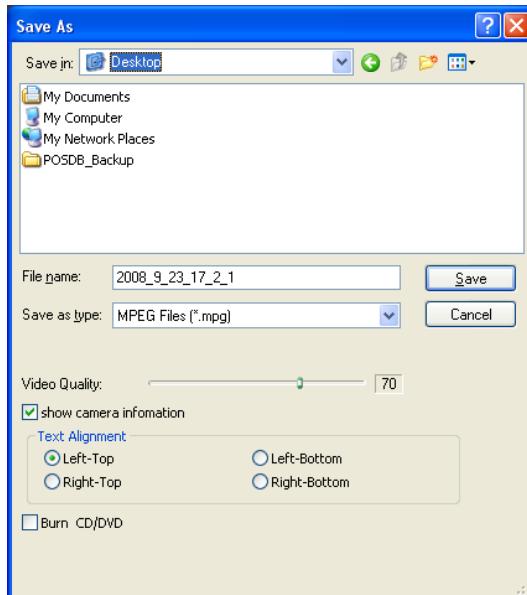

4.10 To Bookmark a Section of the Video

- Click **Bookmark**. The video playback stops when the bookmark button is executed.

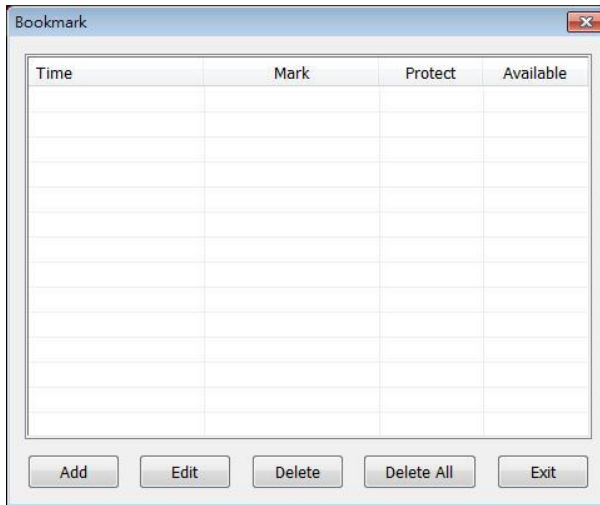

- In the Bookmark dialog box, you may do the following:
 - **Add** to include the new reference mark in the bookmark list. You may select to enable/disable **File Protect** to protect the bookmark file for overwritten.

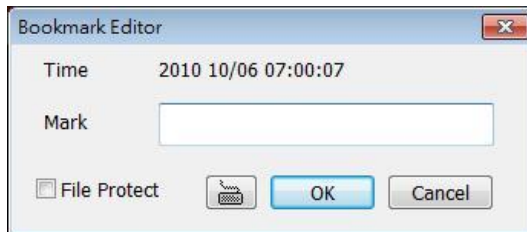



If user has select to enable the file protect, a message dialog will show up to let user to choose to delete protect file or not to delete file when the recycle function has setup (see also [5.1 System setting](#)). Click **Yes** to allow protect file to be deleted, click **No** the protect file will not be deleted even the recycle function has enabled.

- **Edit** to change the mark description or enable/disable file protection.
- **Delete** to remove the selected reference mark in the list.
- **Delete All** to remove all the reference marks in the list.
- **Exit** to close Bookmark dialog box.
- Select and click one in the bookmark list to preview the file.

4.11 To Search Using the Visual Search

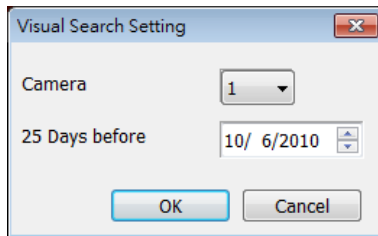
1. Click **Visual Search**.
2. In the Visual Search Setting dialog box, select the Camera number and the date. Then click **OK**.



3. When a series of frames appear by date, click on the frame to display another series of frames and search by every Hour of that date, every 3Minutes of that hour, every 10 Seconds of that minute, every Second of that 10 seconds. To go back, click . To view from the selected frame and close event search, click .



4.12 To Search Using the Event Search

1. Click on the video screen on where you want to search.
2. Click **Event Search**. The Event Search text (red) would appear at the lower left corner of the screen.

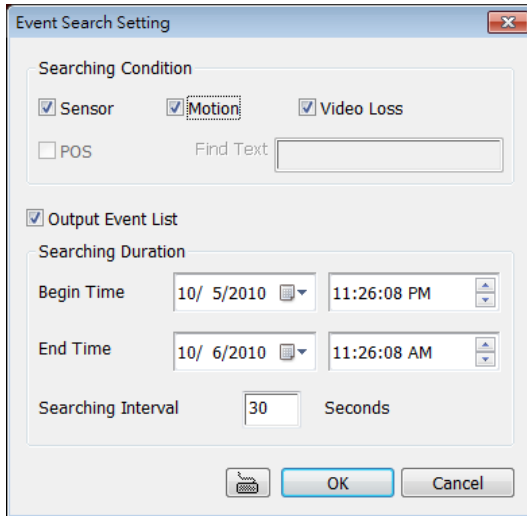

The 'Event Search Setting' dialog box contains the following elements:

- Searching Condition:** Three checked checkboxes for 'Sensor', 'Motion', and 'Video Loss'. An unchecked checkbox for 'POS' is also present. A 'Find Text' input field is located below these checkboxes.
- Output Event List:** A checked checkbox.
- Searching Duration:** Two rows for 'Begin Time' and 'End Time'. Each row includes a date selector (showing 10/ 5/2010 and 10/ 6/2010) and a time selector (showing 11:26:08 PM and 11:26:08 AM).
- Searching Interval:** A text input field containing '30' and the label 'Seconds'.
- Buttons:** 'OK' and 'Cancel' buttons at the bottom right.

3. In the Event Search Setting dialog box, check the type of condition you want to search. If you select POS, in the Find Text box, type the word. Then, click **OK** to start searching. The video search would stop at the frame that matches the condition. To keep on searching click .
4. You may also set to search and list all the result. Just check the **Output Event List** box. In the Search Duration section, set the **Begin Time** and **End Time**. Set the **Searching Interval** time that system won't list out the same events in a period of time that user has setup. Then, click **OK** to start searching.
5. When the Event list appear, click and select the item you want to view.

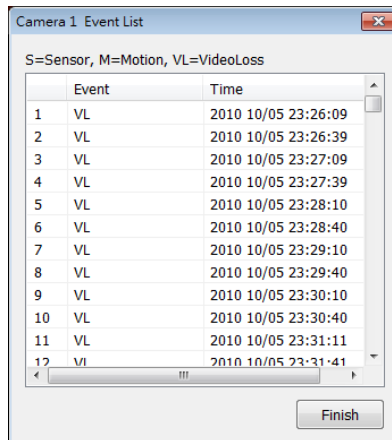

The 'Camera 1 Event List' dialog box displays a table of search results. Above the table, it shows a legend: 'S=Sensor, M=Motion, VL=VideoLoss'. The table has two columns: 'Event' and 'Time'. The results are as follows:

Event	Time
1 VL	2010 10/05 23:26:09
2 VL	2010 10/05 23:26:39
3 VL	2010 10/05 23:27:09
4 VL	2010 10/05 23:27:39
5 VL	2010 10/05 23:28:10
6 VL	2010 10/05 23:28:40
7 VL	2010 10/05 23:29:10
8 VL	2010 10/05 23:29:40
9 VL	2010 10/05 23:30:10
10 VL	2010 10/05 23:30:40
11 VL	2010 10/05 23:31:11
12 VL	2010 10/05 23:31:41

A 'Finish' button is located at the bottom right of the dialog box.

4.13 To Search Using the Intelligent Search

1. Click on the video screen on where you want to search.
2. Click **Intelligent Search**. The Intelligent Search text (red) would appear at the lower left corner of the screen.



3. When the Intelligent Search Setting dialog box and motion detector frame appear, you may adjust the sensitivity bar and the motion detector frame size and location. To set motion detector frame size and location, left click and drag on the screen. Then, click **OK** to start searching. The video search would stop at the frame that matches the condition. To keep on searching click **Find Next**. You may also set to search and list all the result. Just check the **List** box. In the Search Duration section, set the **Begin Time** and **End Time**. Set the **Searching Interval** time for in a period of time won't list out the same events. Then, click **OK** to start searching. The search result will show as below figure:

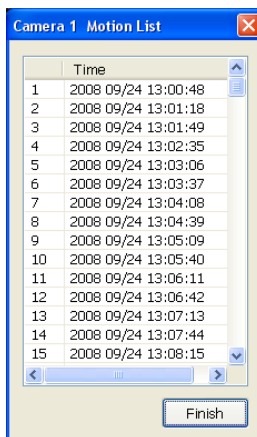

4.14 To Setup the PTZ/IP PTZ Camera

4.14.1 Setup the PTZ Camera

1. In the PTZ control panel, click **Setup**.
2. When the PTZ Setup dialog box appears, select the camera number and check the **Use PTZ** box.

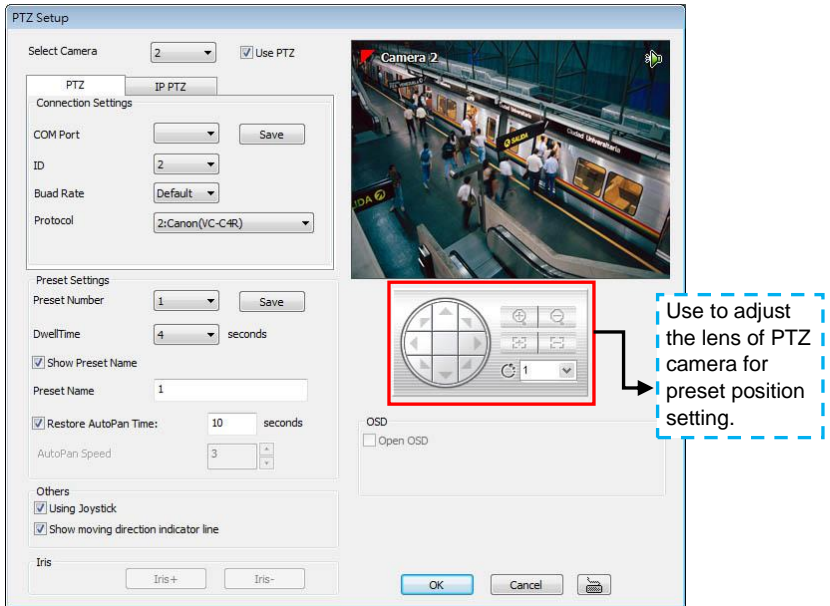

3. In the Connection Settings section, select the **COMPort** where the PTZ camera is connected, **ID** number, **Baud Rate**, and **Protocol**. Then, click **Save** to keep the settings.
4. In the **Preset Setting** section, use the control panel to adjust the position of the PTZ camera and select the preset number to assign a number for the PTZ camera current position. Set the **DwellTime** (1-60 sec) for how long the PTZ camera stays in that position before it moves to the next one. If you want to add description, check the **Show Preset Name** box and in the **Preset Name** text box, type the word. After is done, click **Save** to keep the settings. Set the **AutoPan Speed** if the PTZ camera that user has used is supported.



- The numbers of preset position are depended on the IP camera protocol has supported.
- Only Pelco P protocol can support over 16 PTZ preset points.
- Only **Canon** has supported "**Auto Pan Speed**" function.

5. Repeat step 4 & 5, if you want to save another PTZ camera position.
6. **Restore AutoPan Time**: set a time period for restoring auto path function after the PTZ camera has been moved. Mark the check box and set the time period in second.
7. **Others**: Enable/disable Using Joystick such as USB joystick device.
8. **Show moving direction indicator line**: enable/disable to show the direction line when uses mouse drag on screen in PTZ mode.
9. **Iris**: To adjust the iris of PTZ camera. It may not support that depends on brand of the PTZ camera.
10. **OSD**: To allow call out PTZ camera factory's OSD setup menu if the PTZ camera has supported. The OSD setup menu may vary that depends on the brand of PTZ camera.
11. When is done, click **OK** to save the setting or Click **Cancel**, to leave without saving the new setting.

12. When PTZ camera is enabling, user can control PTZ camera by using PTZ control panel.
13. Click the channel that has supported and enabled the PTZ function. And then, click **PTZ** button on preview UI. The PTZ control panel will show up on the screen.



- User can move the on screen PTZ controller to any position of screen
- The on screen PTZ controller only display on a channel screen at a time.



14. In PTZ screen mode, right-click and drag can enlarge the selected area. After enlarged the area, left-click can move screen to left and right (User should see a hand icon on screen). To return to normal view, right-click on screen again.
15. Please refer to [Chapter 4.6](#) for function of PTZ control panel.

4.14.2 Setup the IP PTZ Camera

1. In the PTZ control panel, click **Setup**.
2. When the PTZ Setup dialog box appears, click **IP PTZ** tab.
3. Select the camera number and mark the **Use PTZ** check box.

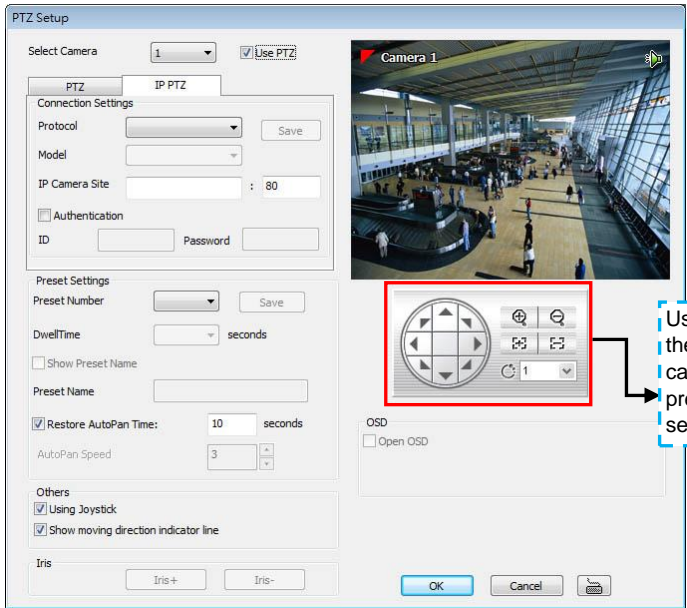

4. In the Connection Settings section, select the **Protocol** and **Model** that is brand of IP PTZ camera and enter the IP or URL of IP camera in **IP Camera Site** column. Mark the **Authentication** box if **ID** and **Password** is required when connecting to IP PTZ camera. And then, click **Save** to keep the settings.
5. In the **Preset Setting** section, use the control panel and adjust the position of the PTZ camera and select the preset number to assign a number for the PTZ camera current position.



- The numbers of preset position are depended on the IP camera protocol has supported.
- Only Pelco P protocol can support over 16 PTZ preset points.
- Only **Canon** has supported “**Auto Pan Speed**” function.

6. Set the **DwellTime** (1-60 sec) for how long the IP PTZ camera stays in that position before it moves to the next one. If you want to add description, check the **Show Preset Name** box and in the **Preset Name** text box, type the word. After is done, click **Save** to keep the settings.
7. Repeat step 5 & 6, if you want to save another IP PTZ camera position.
8. **Restore AutoPan Time**: set a time period for restoring auto path function after the IP PTZ camera has been moved. Mark the check box and set the time period in second. Set the **AutoPan Speed** if the IP PTZ camera that user has used is supported.
9. **Others**: Enable/disable Using Joystick such as USB joystick device.
10. **Show moving direction indicator line**: enable/disable to show the direction line when uses mouse drag on screen in PTZ mode.
11. **Iris**: To adjust the iris of IP PTZ camera. It may not support that depends on brand of the PTZ camera.
12. **OSD**: To allow call out IP PTZ camera factory's OSD setup menu. The OSD setup menu may vary that depends on the brand of IP PTZ camera.
13. When is done, click **OK** to save the setting or Click **Cancel**, to leave without saving the new

setting.

- When PTZ camera is enabling, user can control PTZ camera by using the mouse and on screen PTZ control bar.
- Click the channel that has supported and enabled the PTZ function. And then, click **PTZ** button on preview UI. The PTZ control panel will show up on the screen.



- User can move the on screen PTZ controller to any position of screen
- The on screen PTZ controller only display on a channel screen at a time.



- In PTZ screen mode, right-click and drag can enlarge the selected area. After enlarged area, left-click can move screen to left and right (User should see a hand icon on screen). To return to normal view, right-click on screen again.
- Please refer to [Chapter 4.6](#) for function of PTZ control panel.

Chapter 5 Customizing the NV DVR System

In the Preview/Advanced screen mode, click  button to customize your NV DVR. When the NV DVR configuration setup selection appears, select and click the buttons you want to change the setting.

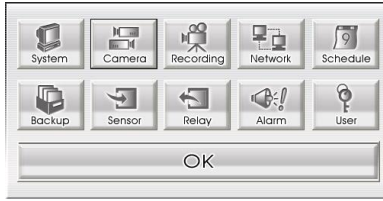

5.1 System Setting

In the System Setting dialog box, click **OK** to accept the new settings, click **Cancel** to exit without saving, and click **Default** to revert back to original factory setting.

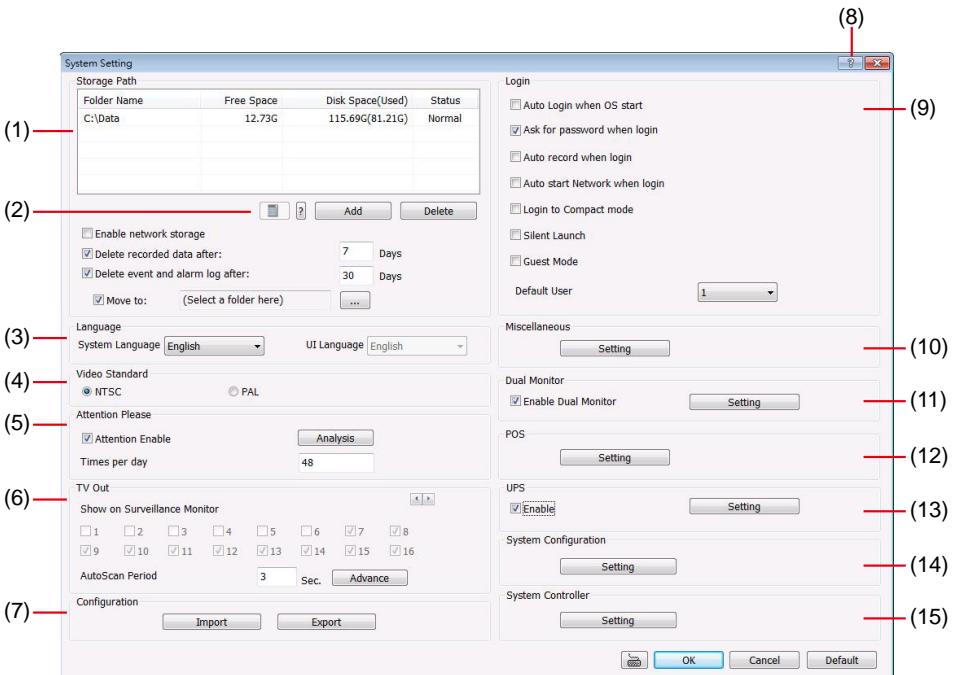

(1) Storage Path

Set the directory on where to save the data. When there is not enough free space to record one hour data, the system automatically replaces the oldest data. In case you have more than one storage path, the system automatically saves the data to the next storage path. You may also add additional network-attached storage (NAS) for extremely high storage capacity. Select the **Enable network storage** check box to send the recorded video in network-attached storage. To add network storage, the Internet storage drive/folder must be mapped as Network Driver in DVR server. Enable network storage first, and then, click Add. In **Browse For Folder** windows, select drive C and right click mouse button, select **Map Network Drive** option.



When using the network storage path, the performance of NAS equipment and your actual network bandwidth might impact the recording and playback performance of the DVR server.

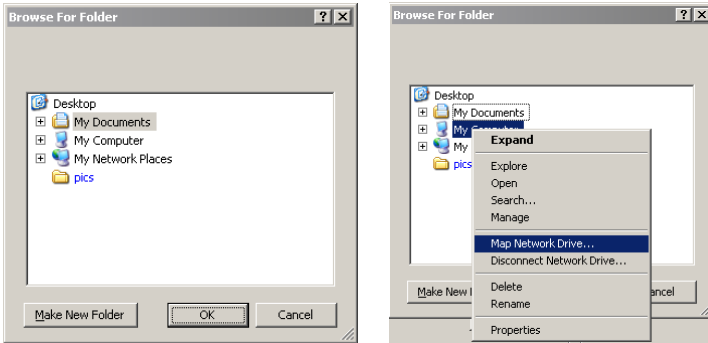

In the **Map Network Drive** windows, select the **Drive** and fill in the network drive direction in **Folder** column if you know. Or click **Browse** to find the folder direction. Click **Finish** to complete the network drive mapping. After the network drive has been added, user needs to create a folder for network storage. In **Browse For Folder** windows, select the network drive and right click mouse button to add a new folder. And then, click **OK**. User should see a new storage folder display in Storage path list.

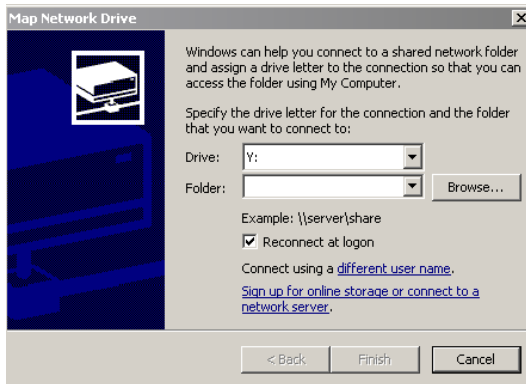

By default the data is stored in C:\Data, to insert another storage path, click **Add**. To remove the selected path, click **Delete**. If you want the system to automatically erase the data after a certain days, enable the **Delete recorded data after** check box and enter the numbers of days in **Days** text box. If you want the system to automatically erase the event and alarm log after a certain days, enable the **Delete event and alarm log after** check box and enter the numbers of days in **Days** text box. To change logs save direction, enable **Move to** and select the new save path.

(2) Hard Disk Calculator

Estimate the hard disk recording capacity. The result of calculation is a rough value which only for reference. The hard disk record capacity will be varied by the real record quality and complexity of video scene.

Click , the hard disk calculator windows will show up. **Total Recording time** is the current hard disk recording capacity. Enter the expect hard disk size or expect recording time in **Expected HD Size** or **Expected Record time**, and then click **Calculate** button. Click **OK** to exit the hard disk calculator windows. The hard disk calculation is based on the recording setup and current hard disk setup.

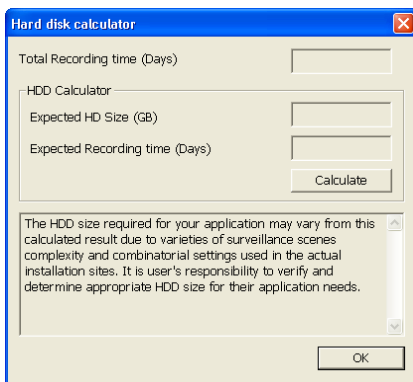

(3) Language

Customize the system to display the tool tips and dialogs based on the selected language. By default the language is in English.

(4) Video Standard

Change and select the proper video system according to your camera video system. If the video system setting is wrong, the video would appear abnormal.

(5) Attention Please

Check the attentiveness of the person who is monitoring the system. You may set the number of times the Attention dialog box to appear in a day in **Times per day** text box. To check the graph on how fast the person response, click **Analysis**.

When this feature is enabled, the **Attention** dialog box would appear. The person who is monitoring the system must enter the same number that appears from the left box to the right text box and then click **OK**.

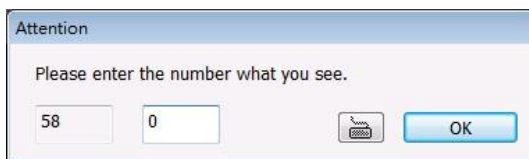

(6) TV Out

Select the camera you want to appear on TV and set the time gap from 3 to 10 sec. before it switches to the next camera.

- **Advance** button (The Advance functions only for NV6000T.)

Select the video card channel and camera that user wants to display on TV.

In Advance mode, user has two types of display selection – **Autoscan** and **Fixed layout**.

⊙ Autoscan



The **Advance** tab will be available when the Display 21 card is installed.

(1) Select the video source from drop down list. If user only installs one NV card on the computer, then there is only one video card channel for selection.

(2) Select the display mode as **Autoscan**.

(3) **Preview screen:** Live camera video would be displayed here.

(4) **View Mode:** Select the video mode user wants to display on screen. The system will auto cycle switch to display the next channels.

(5) **Cameras:** User can select the cameras that user wants to display on the screen. Only those selected cameras would be displayed on the screen. Also, the camera will be displayed by the selecting order.



○ **Fixed Layout**



The **Advance** tab will be available when the Display 21 card is installed.

(1) Select the video source from drop down list. If user only installs one NV card on the computer, then, there is only one video card channel for selection.

(2) Select the display mode as **FixedLayout**.

(3) **Preview screen**: the selected camera video will preview in here.

(4) **View Mode**: Select the split mode of TV out display.

(5) **Cameras**: User can select the cameras that user wants to display on the screen. Only those selected channels would be displayed on the screen. Also, the camera will be displayed by the selecting order.

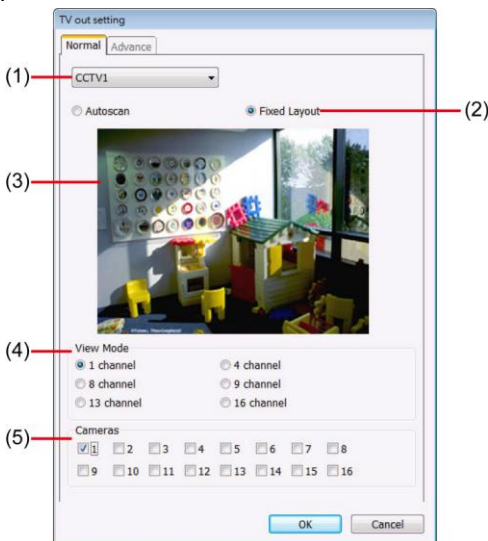

(7) Configuration

Backup a copy of all the settings and allows you to regain the same settings back. To save the current settings, click **Export**. To replace the settings with the one you have saved, click **Import**. The export and import file will include Emap configuration.

(8) Help

Click to call out the user's manual. The manual format is PDF format, please make sure your PC has installed Adobe Acrobat reader and version is 7.0 above.

(9) Login

Enable the conditions in Login section you want the system to automatically carry out.

- **Auto Login when OS start**
Execute the NV DVR when the operating system is started.
- **Ask for password when login**
Request to enter User ID and Password each time the NV DVR is executed.
- **Auto record when login**
Automatically start video recording when the NV DVR is executed.
- **Auto start Network when login**
Automatically enable NV DVR network connection when login into NV DVR program.
- **Login to compact mode**
Switch to compact mode directly when the NV DVR is executed.
- **Silent Launch**
Enable the DVR system minimizes on the system tray automatically right after start up.
- **Guest Mode**
Automatically log in Guest mode when the NV DVR is executed. In guest mode, the functions are limited to preview and playback only.
- **Default user**
Automatically log in to the selected default user when the NV DVR is executed.

(10) Miscellaneous

Enable the conditions in **Miscellaneous** section you want the system to perform.

Miscellaneous Setting

Status Report Setup

Desktop Lock Detail

Beep if no signal

Shut down OS when exit

Mandatory recording

Enable overlay

Enable Liveplayback

Screen Saver [] Minute wait

Leave the system without asking user name and password

Resequence channels when autoscan

Remember playback display mode

AutoScan Period 3 Sec.

Temperature Display °C

Playback Mode Instant Playback

Set Instant Playback's Play Time 30 Sec.

Date Format mm/dd/yy

OK Cancel

- **Status Report**

Send a daily system event and attention analysis report. To change the e-mail settings, click **Setup**.

- **Desktop Lock**

- ✓ **Block window OS hotkey:** Deactivate the [Ctrl-Alt-Del] and [Windows] keyboard key functions.
- ✓ **Block windows OS pop-up window:** To block any pop-up window from windows system.



- **Beep if no signal**

Make sound when the video signal is lost.

- **Shutdown OS when exit**

Turn off the PC when the NV DVR application is being closed.

- **Mandatory Record**

Always record video when software is running

- **Enable Overlay**

To enhance video signal for better video quality.



Enable overlay doesn't support on NV3000T and NV5000T card.

- **Screen Saver**

Set a period time to enter screen saver mode when system idle.

- **Leave the system without asking user name and password**

Don't need to enter password when close/exit NV DVR program.

- **Resequence channels when autoscans**

The DVR system will re-arrange the channels order if some of channel is disable when auto scan is enabled. For example, CH 1 and 3 is disable, the channel will display in order of CH2,4,5,6,7~16. The CH1 and 3 won't be shown on screen when auto scan is enabled.

- **Remember playback display mode**

To memorize the last playback status. The DVR system will memorize the playback status from last time that user has selected or setup.

- **Auto Scan Period**

Set the time gap of the Auto Scan function from 3 to 10 seconds. This automatically switches to the next video in cycle depending on the set time gap.

- **Temperature Display**

Select the format of temperature -- °C or °F

- **Playback Mode**

Select the mode of playback the video.

- ✓ **Select date and time:** Select the date and time which user wants to playback.
- ✓ **Play the last file:** Automatically playback the video from the last hour
- ✓ **Instant Playback:** Automatically playback the video which has just recorded. To set the instant playback time period, fill in the time in second at **Set Instant Playback's Play Time** column.

- **Date Format**

Select the date format which wants to display in **Select date and time** playback mode

(11) Dual Monitor

Enable/disable dual monitor display. Click **Setting** to select display order of Preview (main system), Playback, and EMap.

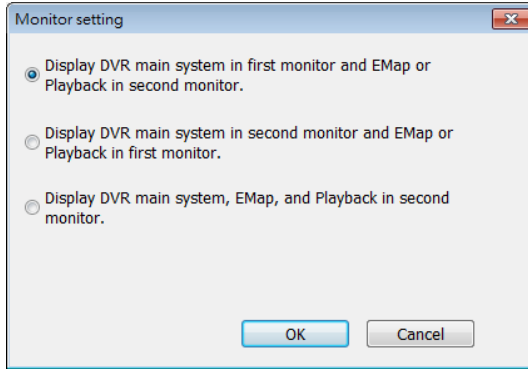

(12) POS

Set from which camera screen to display the data from the POS equipment. Click **Setting**, to set the POS Console Setting. (see also [Chapter 5.1.1](#))

(13) UPS (Uninterruptible Power Supply)

Protect the system from damaging, such as power surges or brownouts. This automatically gives time to close the NV DVR properly when the battery backup power has reached the **Shutdown when capacity below** percentage level setting. The UPS device must be connected to your computer (refer to your UPS user's guide).



The UPS application must meet Windows XP, Windows Vista, Windows 7 system requirements.

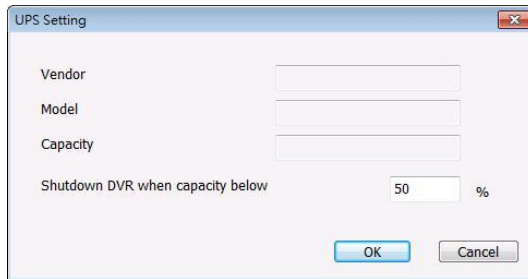

(14) System Configuration



The System Configuration function doesn't support on **Windows Vista** and **Windows 7**.

To configure the DVR system date, time and IP address.

Date/Time Setting

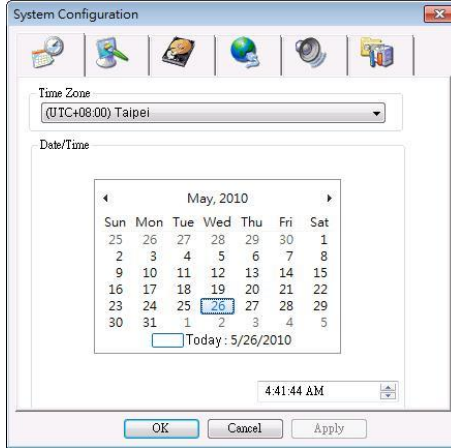

1. Select the **Time Zone** of DVR server located
2. Select the **Month** and **Date**. Click arrow button can switch to different month.
3. Adjust the **Time** by click spin box arrow button.
4. Click **OK** to save the configuration.

Display Setting

To adjust resolution of display.

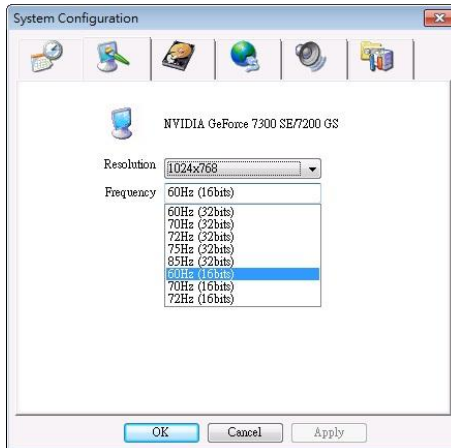

HDD Management

To manage and format the hard disk drive. The DVR system can format the HDD that is the first time install on DVR system. The NV system supports iSCSI hard disk.



- Please stop recoding before formatting HDD.
- The hard disk has been added into storage path that is not able to re-format and partition.

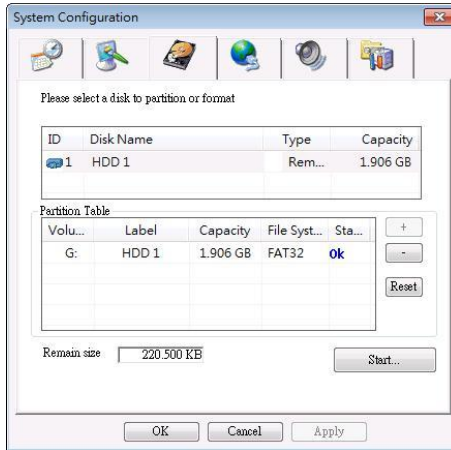

To format and partition hard disk:

1. Click **+** button to add the selected hard disk into **Partition Table** section.
2. User can adjust the capacity of partition by clicking **Capacity** column and enter the capacity. If user doesn't want to divide hard disk into several partitions, and then, just leave the capacity without change.
3. The partition can be named by clicking on **Label** column and enter the name.
4. To create more than one partition, do the steps 1 and 2 again.
5. When all the partition has been added, click **Start** to format all partitions.
6. When the formatting complete, the each partition status will change to **OK**.
7. Click **OK** to exit when formatting is completed.
8. Now, user can assign formatted hard disk or partition as a storage path(see also [Chapter 5.1 System setting\(1\)Storage Path](#))

Network Setting

To configure the network setting (IP address, subnet, DNS, and son on...) of the system.

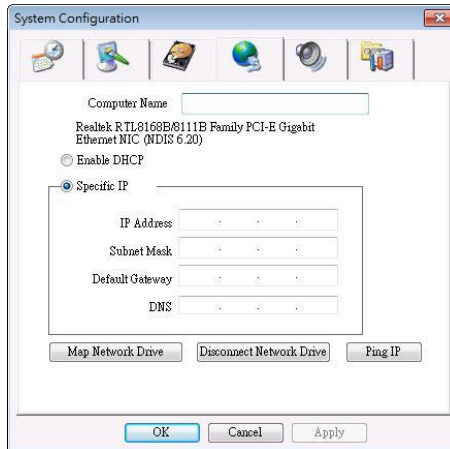

- **Obtain an IP automatically (DHCP):** To use DHCP server assigning DVR server a IP address.
- **Using the following IP address:** Assign a fixed IP address for DVR server
 - **IP ADDRESS:** Assign a constant IP address which a real IP addresses give from ISP to DVR system.



Do Not assign the DVR to 1.0.0.0 network segment. It will cause the DVR cannot access to Internet due to the un-recognize to 1.0.0.0 IP segment.

- **Mask:** It is a bitmask used to identify the sub network and how many bits provide room for host addresses. Enter the subnet mask of the IP address which user has assigned to DVR system.
- **GATEWAY:** A network device act as a passageway to internet. Enter the network gateway IP address
- **DNS:** Enter the IP address of DNS
- **Map Network Drive:** To add network storage, the Internet storage drive/folder must be mapped as Network Driver in DVR server. Follow the below steps to map the network drive.
 1. Click **Map Network Drive** button. In the **Map Network Drive** windows, select the **Drive** and fill in the **IP address** and **file folder** of file server or NAS on your network in **Folder**.
 2. And then, click **Finish** to make the connection.

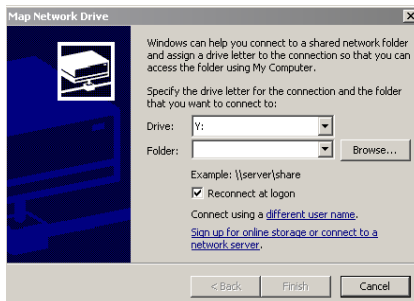

3. After connection successful, user should see the network drive on the **Storage Path**.
 4. To disconnect the mapping network drive, click **Disconnect Network Drive**.
- **Ping IP:** Allow user to ping and trace the certain IP address of network/server device on the network.



Audio Setting

To adjust audio volume of system.

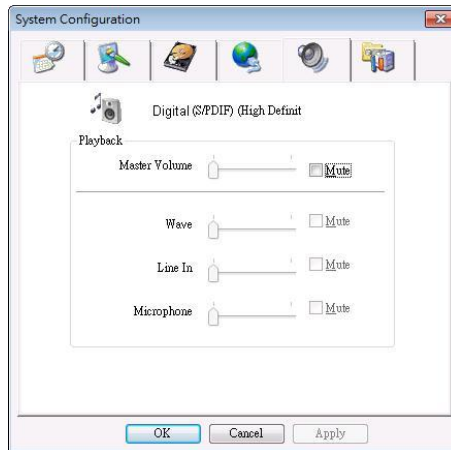

Others

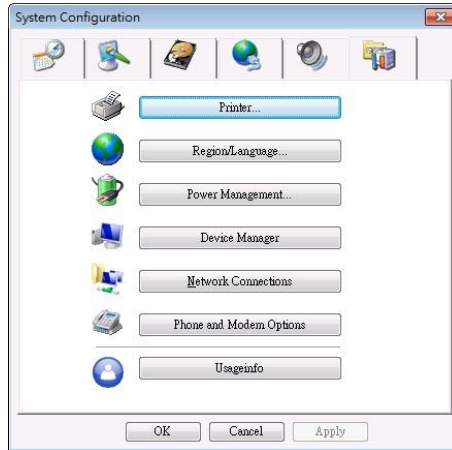

Printer Setting

Click **Add Printer** and following the wizard to install a printer.

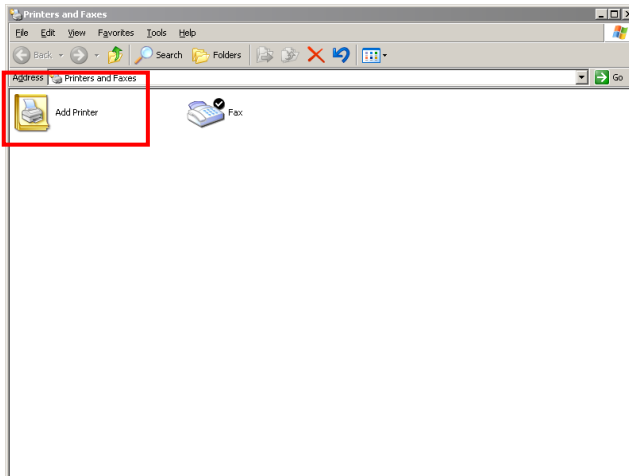

Regional/Language Setting

When DVR application is using different language of UI besides English, user can select the corresponding region and language in order to make UI display correctly.

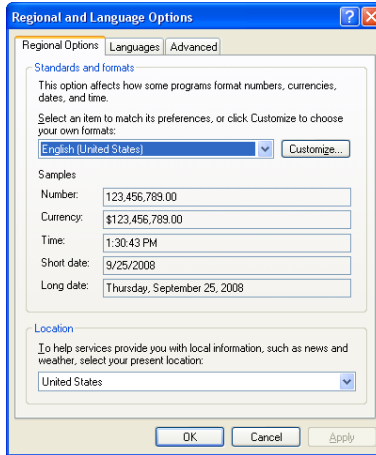

Power Management

To configure UPS. Click **Select...** to select the UPS that has connected with DVR system.

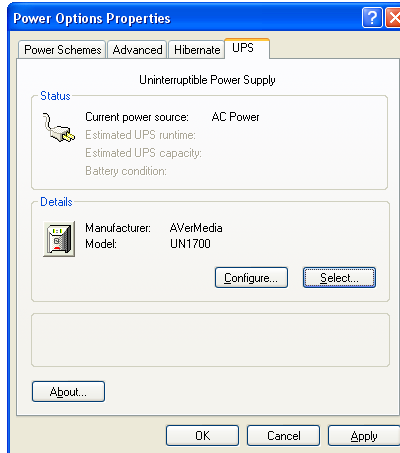

Device Management

To manage the DVR system devices.

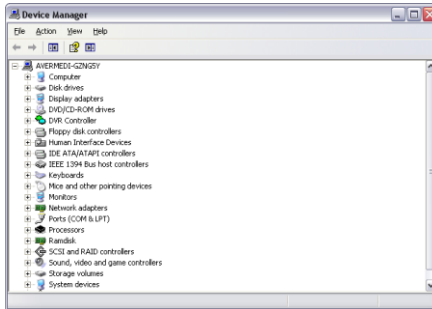

Network Connection

To manage the connection of the network.

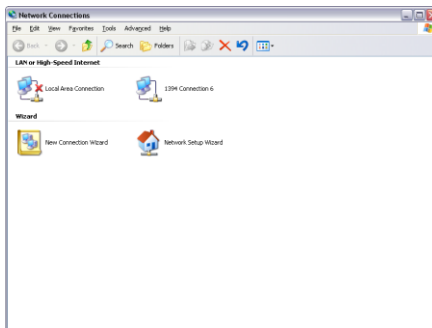

Phone and Modem options

To setup the modem dial-up settings.



Usageinfo

To view usage of the system CPU, memory, and network.

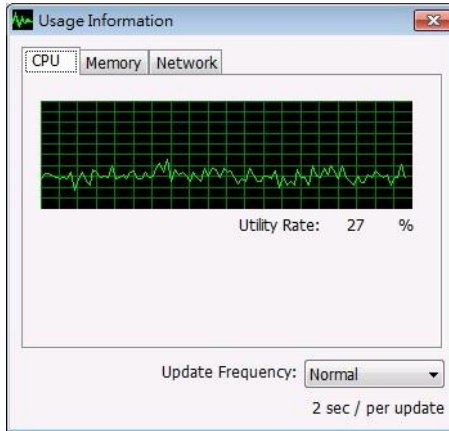

(15) System Controller Setup

To configure the parameters that is for communicating with the System Controller (an optional accessory). For operating of the System Controller, please refer to [Chapter 5.1.2](#).



- **Enable** – Mark the check box to enable the System Controller function.
- **Upgrade** – To update the firmware of the System Controller (see also [Upgrading the Firmware of the System Controller](#)).
- **Model** – Select model of the System Controller. If System Controller is connecting to DVR through the USB port, please select the **System Controller Pro** mode. If System Controller is connecting to DVR through the RS485 port, please select the **System Controller Pro 485** model.



- **Port** – Select the com port that is connected with the System Controller Pro.
-



Only when System Controller is using RS485 port connect to DVR server, the port needs to be selected.

- **ID** – Set an ID for DVR server (0~99). This ID is a key for the System Controller to control the DVR server when there are more than one DVR servers are connecting with the System Controller through the RS485 port(see also [Switch Control on Multiple DVR Servers](#)).

5.1.1 To Set the POS Setting

General Setting

1. In the System Setting dialog box, POS section, click **Setting**.
2. In the POS Console Setting dialog box, click **Add** to set a new POS setting, **Modify** to change the POS setting, and **Delete** to remove the selected POS setting. Click **OK** to save and close POS Console Setting.

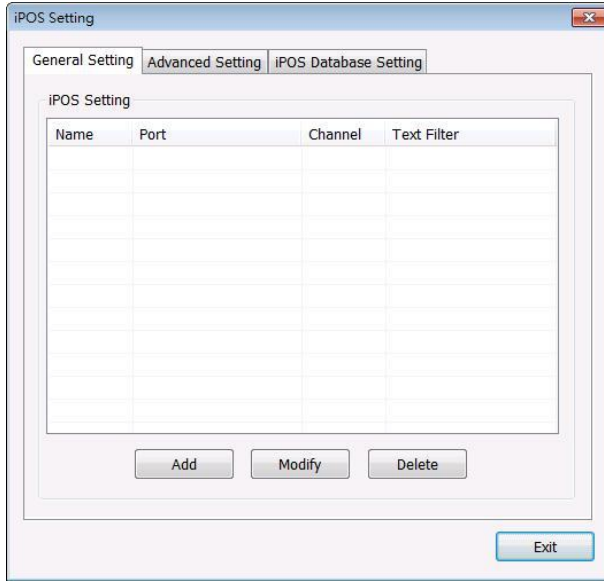

3. In the POS Mapping dialog box, click **OK** to accept the settings and **Cancel** to exit without saving the new setting.

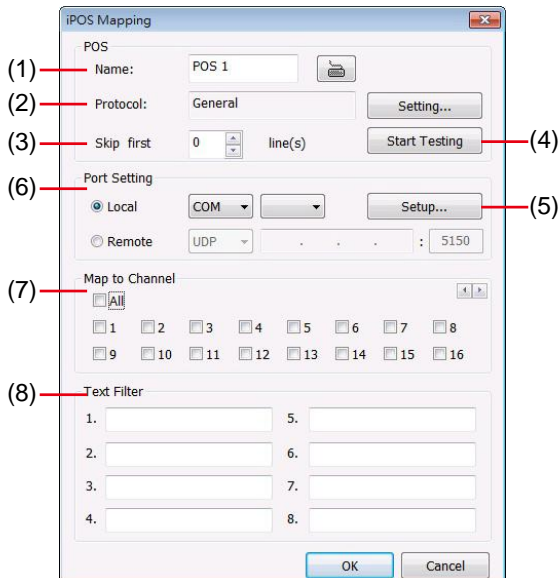

- (1) **POS Name:** Enter a name to identify the POS.
- (2) **Protocol:** To select the protocol, click **Setting** button (see Setup POS Protocol)
- (3) **Skip first:** Set the number of lines you want to be removed
- (4) **Start Testing:** Click to test POS setting. You will see a test result on the right side of POS Mapping window.
- (5) **Setup...:** Set the COM Properties. If you are not sure, please contact your POS service provider.
- (6) **Port Setting:** Select the Local or Remote port to where it is connected.
 - Local** - select the COM port number which is connected.
 - Remote** – Use the UDP protocol for remote connection if POS system can broadcast to Internet. Enter the IP address of the remote station.
- (7) **Map to Channel:** Select to which camera number to display the transaction text.
- (8) **Text Filter:** Enter the word you want to be removed.

Setup POS Device

There are 4 default POS devices. If user uses the POS device beside defaults, user can add new POS device and rules. The POS device can be added up to 50 include defaults.

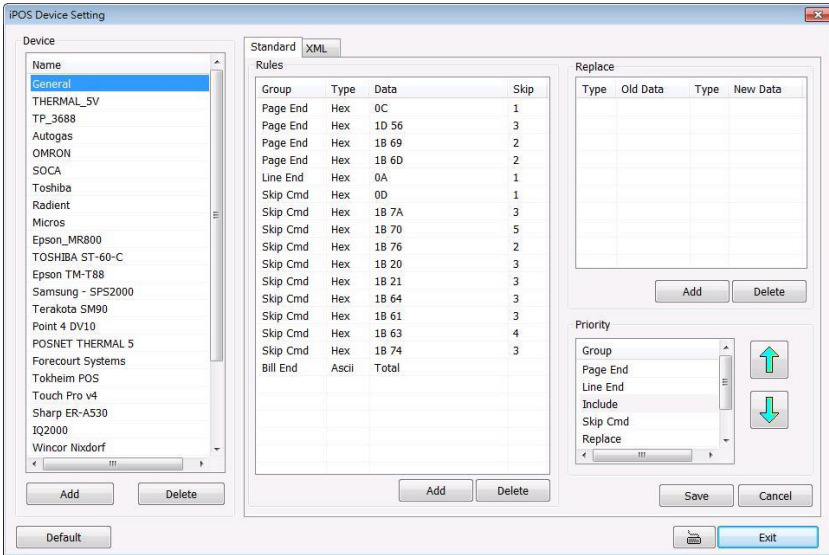

Setup Standard POS Device

■ Add New POS Device

1. Click **Add**
2. Enter the POS device name in **Name** column
3. Select the **Type** as **Standard**
4. Click **OK** to save
5. To modify existing device, double click it.
6. Click **Default** can be reset back to original setting.

■ Add Rules

1. Select the POS device form device list
2. Click **Add** in Rules section
3. In Rule Setting windows, select **Group**. Each group has a limited number of times ; please refer to the "**Maximum**" and "**Remainder**" information in Rule Setting windows. The Line End, Page End, and Bill End group only can be set once.
 - **Line End**: set a rule to separate each line.
 - **Page End**: set a rule to switch page.
 - **Skip Cmd**: set a rule to discard a string or character.
 - **Include**: set a rule for a lime with a string or character to be displayed.
 - **Exclude**: set a rule for a line with a string or character to be concealed.
 - **Bill End**: set a rule to divide each transaction.
4. Select **Type** – Ascii or XML
5. Enter the string or character as the rule in **Data** column. The maximum length is 31 characters.
6. Click **OK**
7. Click **Save**. The configuration will be lost without saving.
8. To modify existing replace rules, double click it.

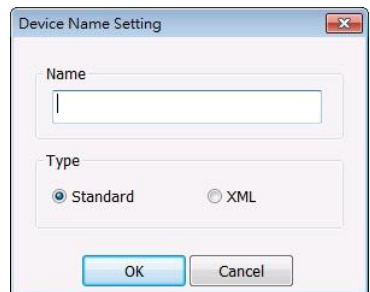



■ Character Replacement

Set a rule to replace a character or word in POS data. The maximum replacement is 8.

1. Select a POS device from device list
2. Click **Add** in Replace section
3. **Old Data:** select the **Type**(Ascii or Hex) and enter word or character that wants to be replaced
4. **New Data:** select the **Type** (Ascii or Hex) and enter the word or character that will replace it in Old Data.
5. Click **OK**
6. Click **Save**. The configuration will be lost without saving.
7. To modify existing replace rules, double click it.

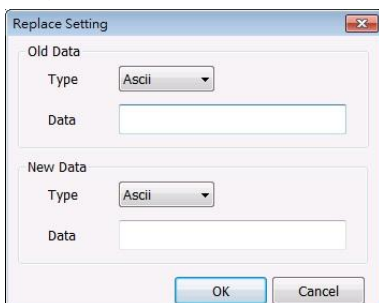

■ Adjust Rule Priority

User can set the priority of rule groups. Select the group and click up/down arrow button to move the priority level. The upper position, the priority is higher.

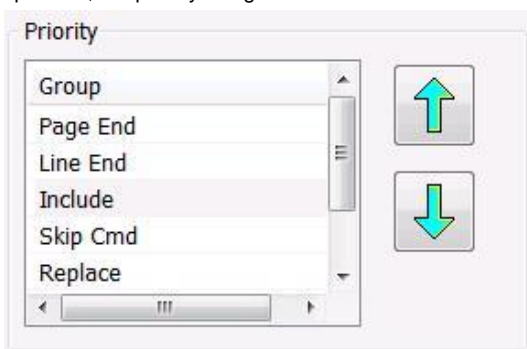

Setup XML POS Device

XML can only work with the POS data is transmitting in XML format.

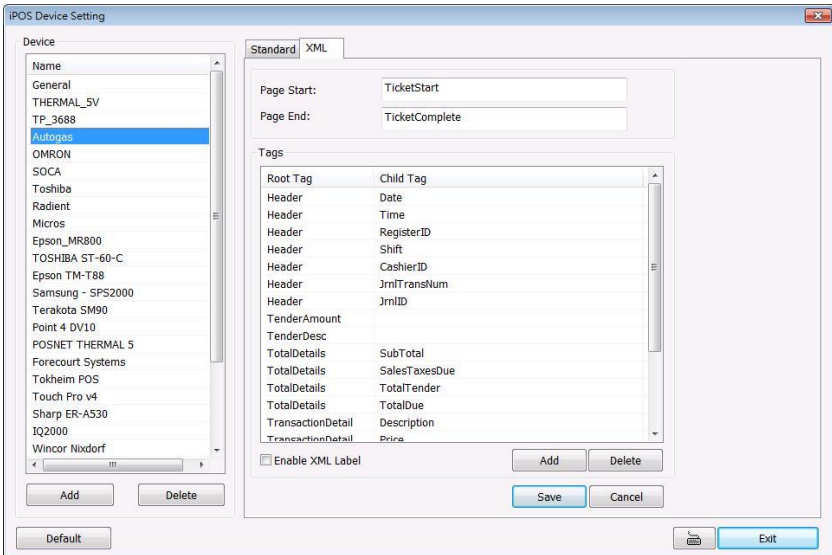

- ✓ **Device:** select or add a new device. Only device that supports XML can be configured in here. Click **Add** to add a device. Enter device name and select Type as **XML**. The POS device can be added up to 50 include defaults.

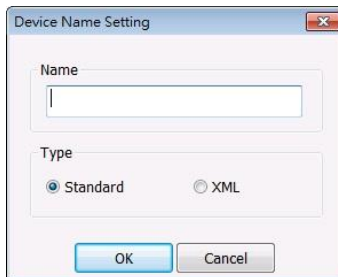

Page Start: Beginning of data for transaction

Page End: End of data for transaction

Tag: select a root tag and sub tag as a range for data transaction to DVR server. Click **Add** to set a tag. Click **Save**. The configuration will be lost without saving.

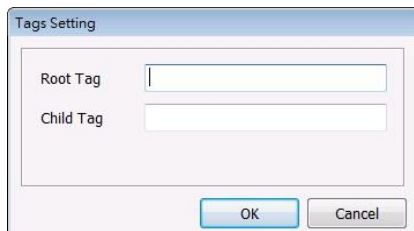

Please refer to the following example for more detail.

<TicketStart> → **Page Start**

<Header> → **Root tag**

```

    <MessageVersion>1.0</MessageVersion>
    <Date>20060317</Date>
    <Time>164216</Time>
    <RegisterID>3</RegisterID>
    <Shift>4</Shift>
    <CashierID>000000009</CashierID>
    <JrnlTransNum>3</JrnlTransNum>
    <JrnlID>0</JrnlID>
  
```

} → **Sub tag**

</Header>

</TicketStart>

<Item>

<SaleTotals>

<Item>

<SaleTotals>

<Item>

<SaleTotals>

<TenderEvent>

<TicketComplete> → **Page End**

Page Start:

Page End:

Tags

Root Tag	Child Tag
Header	Date
Header	Time
Header	RegisterID
Header	Shift
Header	CashierID
Header	JrnlTransNum
Header	JrnlID
TenderAmount	
TenderDesc	
TotalDetails	SubTotal
TotalDetails	SalesTaxesDue
TotalDetails	TotalTender
TotalDetails	TotalDue
TransactionDetail	Description
TransactionDetail	Price

Enable XML Label

Advanced Setting

To setup POS text display position, text font and color.

1. In the System Setting dialog box, POS section, click **Setting >> Advanced Setting**
2. Mark **Show POS Text** to allow POS data to be display on surveillance screen.
3. If user doesn't want POS data to be scroll up, mark **Stop scroll POS Text** and enter the time to delete POS text at **Erase POS text after** column.
4. Select the POS data display position on surveillance screen – Left-Top, Left-Bottom, Right-Top, or Right-Bottom.
5. Mark **Multiple Windows** to allow more than one iPOS live data window (see also [iPOS Live](#) in Preview mode) display on the preview screen mode.
6. Mark **Save Window Position** that iPOS live data window position (see also [iPOS Live](#) in Preview mode) will be saved as next time call out position when close.

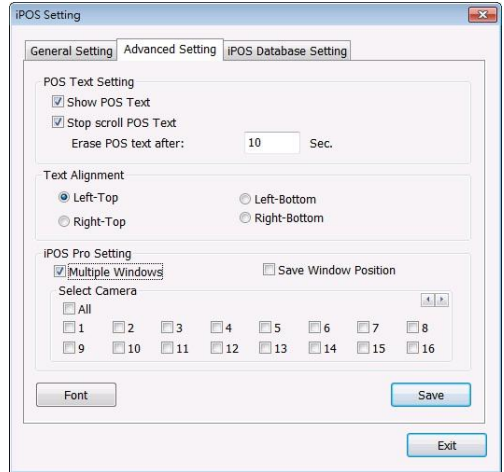

If user has changed dual monitor to single monitor, please un-selected “**Save Window Position**” function to prevent the iPOS live window stay in 2nd monitor screen when user call out iPOS live window.

7. Select the **Cameras** of iPOS live data that want to be display on Preview mode when the **iPOS Live** function has been enabled. To select all cameras, mark **All**.
8. To change the POS data font and color, click **Font**.
9. When it is done, click **Save** to complete the configuration.

POS Database Setting

User can export the POS database to another save location or storage device. Click to change the save path. Mark **Remove POS data after** the POS data will be delete from DVR hard disk on the day that user has setup. Also, mark **Move to:** user can save the POS data to another folder on DVR when the POS data is removing. Click to set a storage path.

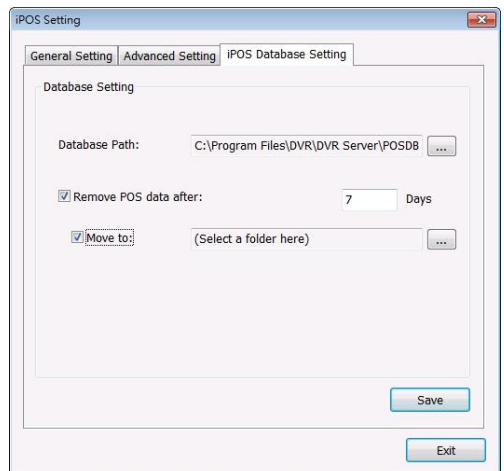

5.1.2 Operating the System Controller

The AVerDiGi System Controller Pro provides user an easy way to operate DVR server (NV/SA series).

Hardware Introduction

Left Side

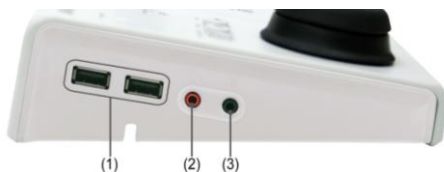

Function	Description
(1) USB Port	2 * USB ports for connection of keyboard, mouse, or USB flash memory.
(2) Audio Input	For audio input device connection such as microphone.
(3) Audio Output	For audio output device connection such as speaker.



- The audio input and output device has its own power supply is necessary.
- The audio input and output port act as the audio input and output port on the DVR system.

Rear Side



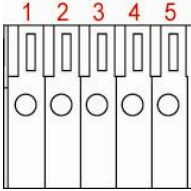



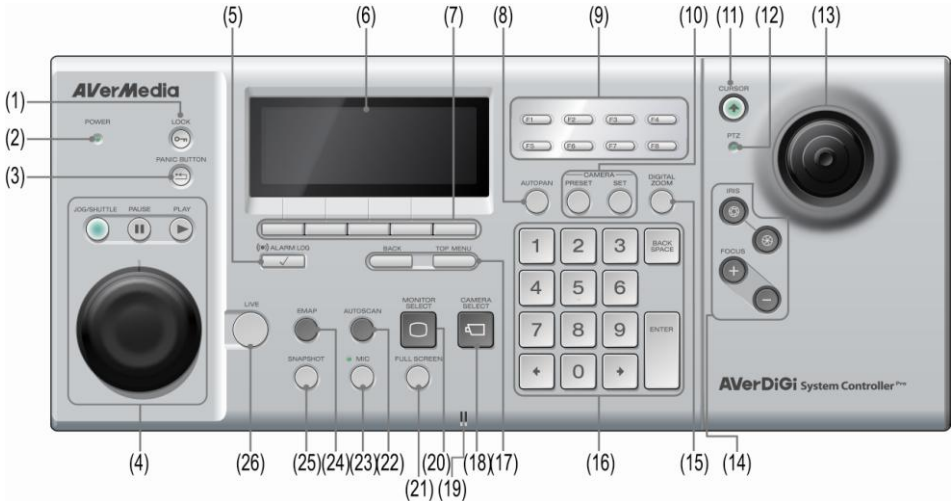















Function	Description										
(1) RS485 Port	For connection of Pelco-D/P PTZ camera and DVR server. To connect with DVR server, user needs a RS485 to RS232 converter (see also Connecting the DVR Server through the RS485 port).										
	<table border="1"> <tbody> <tr> <td>1</td> <td>TX+</td> </tr> <tr> <td>2</td> <td>TX-</td> </tr> <tr> <td>3</td> <td>RX+</td> </tr> <tr> <td>4</td> <td>RX-</td> </tr> <tr> <td>5</td> <td>GND</td> </tr> </tbody> </table> 	1	TX+	2	TX-	3	RX+	4	RX-	5	GND
1	TX+										
2	TX-										
3	RX+										
4	RX-										
5	GND										
(2) Power Supply Port	For AC power adaptor connection.										











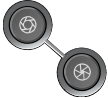

Familiarizing with System Controller Panel Buttons







System Controller Panel figure

Function	Description
(1)  (Lock)	To lock panel buttons and all operations are lock. Press it to lock and press again to un-lock. If the system password has been set, please enter the password to un-lock (see also Locking System Operation)
(2)  (Power)	Lights up when unit is power on.
(3)  (Panic Button)	To trigger the alarm buttons that user has defined (see also Trigger the Alarm Button). To setup alarm button, please refer to Chapter 5.9 step 5 . If the alarm button hasn't been defined, there is no any action when alarm button is selected to trigger.
(4) Playback Control Buttons	 (Jog/Shuttle) Enable/disable the jog/shuttle function. When button lights up is enabling.  (Pause) To pause the playback.  (Play) To switch to playback mode and start playback.  (Jog/Shuttle) <ul style="list-style-type: none"> - Jog dial (top part): Playback video at faster forward or rewind speed that control by user. - Shuttle ring (lower part): Playback video frame-by-frame that control by user.
(5)  (Alarm Log)	To call out the alarm log window. To close alarm log window, press the button again.
(6) LCD Screen	To operate the each function in multi-functions menu and view system related information.

Function	Description
(7) Multi-function Buttons	Each button represents a function that is corresponding to the function display on the LCD screen. Press the button and operate it (see also Multi-Functions Menu).
(8) 	Enable/disable the PTZ camera move automatically that is based on the selected camera group preset position number (see also Enabling the AutoPan).
(9) Custom Function Buttons	 To view system information.
	 Enable/disable recording. Press it to start recording and press again to stop recording. The authentication password is required for stop recording. Using keyboard to enter the password and press Enter button to confirm.
	 Enable/disable network connection. Press it to connect the network and press again to disconnect the network. The authentication password is required for stop network connection. Using keyboard to enter the password and press Enter button to confirm.
	 To enter system setup mode. The authentication password is required to enter system setup mode. Using keyboard to enter the password and press Enter button to confirm.
	 The number buttons on System Controller don't support for any account and password entering on DVR server.
	 To freeze/un-freeze the surveillance screen. Press it to freeze the screen and press again to un-freeze.
	 To extend/fold camera tree window.
	 Open/close PTZ control panel. Press it to call out the PTZ control panel and press again to close it.
(10) Preset/Set Button	 Move the PTZ camera to the selected preset position (see also Setup preset position and Use Preset).
	 To setup the PTZ preset position (see also Setup preset position and Use Preset).
(11) 	Enable/disable joystick as a mouse function.
(12) 	When lights up in green, user can use PTZ related operation (see also PTZ Operation).
(13) Joystick	To control PTZ camera to left, right, up, down, zoom in, and zoom out.

Function	Description
(14) IRIS/Focus Button	 <p>To adjust the brightness of the image.</p> <p>(IRIS)</p> <hr/>  <p>To adjust the focus of the PTZ camera.</p> <p>(Focus)</p>
(15) DIGITAL ZOOM	 <p>Enable/disable digital zoom (see also Using Digital Zoom).</p>
(16) Number buttons	 <p>For numbers entering</p> <hr/>  <p>The number buttons don't support for any account and password entering on DVR server.</p> <hr/> <p>Enter button For confirmation</p> <hr/>  <p>To exit from current status.</p> <hr/>  <p>Moving the cursor to left or right.</p>
(17) Back /Top Menu Button	<p>BACK</p>  <p>Go back to previous multi-function menu screen.</p> <hr/> <p>TOP MENU</p>  <p>Go back to the main menu screen.</p>
(18)  (Camera Select)	Using to select the camera channel (see also Select a Camera)
(19) Microphone	Build-in microphone
(20) Monitor Select	To select a DVR ID to control in multiple DVR server control situation(see also Switch Control on Multiple DVR Servers).
(21) FULL SCREEN	 <p>Switch to full screen mode.</p>
(22) AUTOSCAN	 <p>Enable/disable channel display cycle automatically. Press it to start auto pan and press again to stop.</p>

Function	Description
(23) 	When button is pressed and lights up, the System controller can receive the sound.
(24) 	Switch to Emap mode. In Emap mode, user can select different emap to view(see also To View the Emap)
(25) 	Take a quick photo shot of the surveillance screen and save it.
(26) 	Switch to preview/live view mode.

Hardware Installation

Connecting the DVR Server through the USB port

The following is an example of System controller installation.

1. The DVR server should be power on and DVR program is executed.
2. Plug the power cord of the System Controller into power outlet.
3. And then, plug the USB cable that is attached on the System Controller to the USB port of the DVR server.
4. The DVR system will install the drives automatically when the System Controller connects to the DVR system. Please wait a while for driver installation completing.

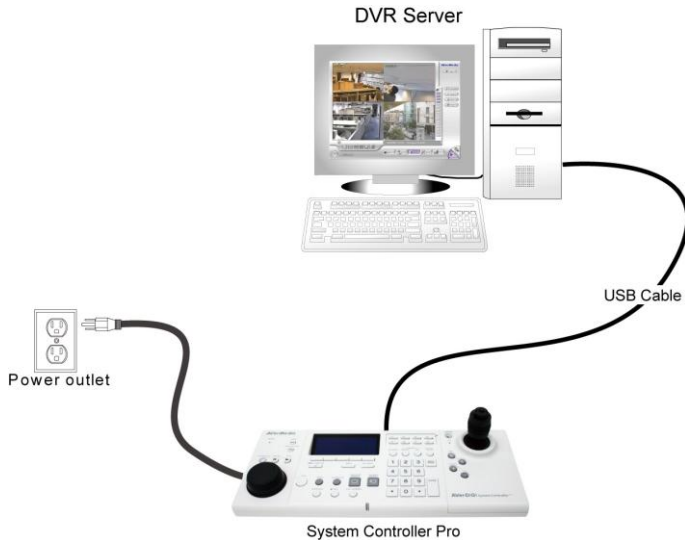

Connecting the DVR Server through the RS485 port

Through the RS485 port, user can connect multiple DVR servers with the System Controller. Before starting to make a connection, please prepare the following items:



RS232 cable



RS485 to RS232 Converter



Single core wire

(*User can purchase from the dealer
 ** The RS232 to RS485 Converter needs to support **RS-485 automatic data direction control protocol**)

- Using the screwdriver to press down the orange tenon and insert the single core wire cable into the pin hole of the I/O terminal on the System Controller. When the wire cable is inserted in the end of the pin hole, release the orange tenon to fix the wire cable.

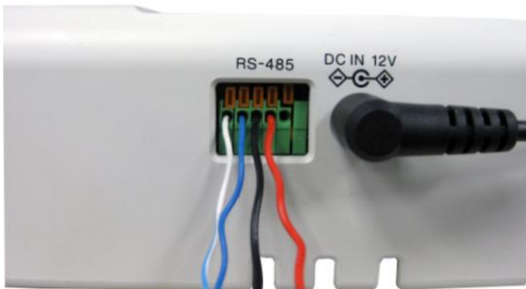

- Set the DIP switch of the RS232 to RS485 converter at 4-wire RS485 setting.



Using 4-wire RS485 for connection

Adjust the switch to the right position

- Using the screwdriver to lose the pin hole of RS485 to RS232 converter. And then, insert the another side of single core wire cable into the pin hole of the RS485 to RS232 converter. Using the screwdriver to screw tight the wire cable.

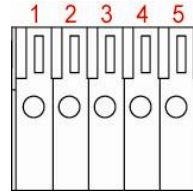

RS485 pin hole of System Controller

RS485 to RS232 Converter site	System Controller site	
R+	T+	1
R-	T-	2
T+	R+	3
T-	R-	4

- Connect the RS232 cable to the RS232 port of the RS485 to RS232 converter.



- Connect another side of RS232 cable to the RS232 port of the DVR server.
- Power on the System Controller.
- The following figure is an example of the installation illustrate.

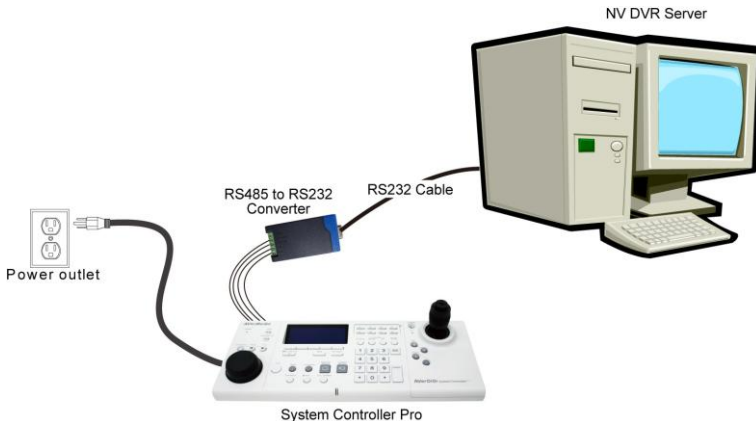

- After hardware installation has complete, please remember to enable the System Controller in

NV DVR system (see also [\(15\) System Controller Setup](#) in [Chapter 5.1 System Setting](#)).

9. How to operate the multiple DVRs; please refer to [Switch to 485 DVR mode](#) and [Switch Control on Multiple DVR Servers](#).



Please **Do Not** install System Controller and PTZ camera in RS485 port of DVR server at the same time. It might cause conflict on operation.

Operating the System Controller Pro

Using the System Controller for the First Time

For the first time using the System Controller, please select the model of System Controller in DVR server.

Follow the below steps to select the model:

1. Start up the DVR program.
2. Click **Setup**.
3. Select **System**, the **System Setting** windows will appear.
4. Click **Detail** that is next to the System Controller selection.
5. Mark **Enable** check box to enable the function of the system controller.
6. Select the **Model** as **System Controller Pro (USB connection)** or **System Controller Pro 485(RS485 connection)**. When DVR server has detected the System Controller device, user should see the model name **System Controller Pro** in drop-down list.
7. For System Controller Pro 485 model, user needs to select the connection **Port**. If there is more than on DVR systems are connecting with System Controller, user can assign a **DVR ID** for the DVR system as a control identity.
8. Click **OK** to complete the setting.

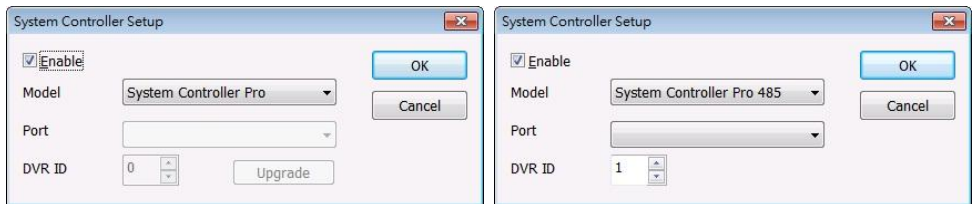

9. If the setting is complete, the LCD of System Controller should display like following figure.



Upgrading the Firmware of the System Controller

User can upgrade the newest firmware of the System Controller. For newest firmware, please contact your local dealer.



The upgrade process doesn't support when System Controller connect to DVR server through the RS485 port.

1. In NV DVR program UI, click **Setup > System > Detail** of System Controller.
2. Click **Upgrade** button.

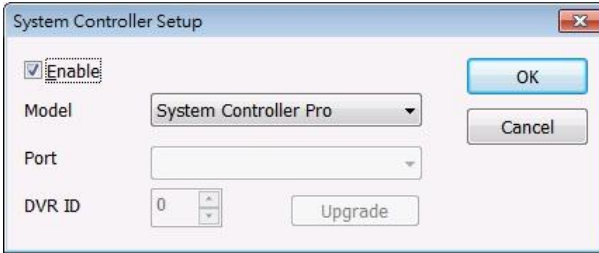

3. Click **Select File** button to locate the firmware.
4. Select the firmware file and click **OK**. The upgrade process will start.
5. The upgrade firmware may have more than one file. Therefore, click **OK** and locate the firmware file to upgrade another file.
6. When the upgrade process is done, click **Finish** to complete.

Switching to USB DVR Mode

When the System Controller is connecting with DVR system through the USB port, the System Controller mode should be in **USB DVR** mode in order to operate the DVR system. If the mode is not USB DVR, please follow the below steps to switch to USB DVR mode.



- The default mode is USB DVR mode
- The USB CMS and 485 DVR mode is supported for CMS application.
- If System Controller is connecting with PTZ camera through RS485 port, please refer to [Operating in PTZ 485 Mode](#) for operation description.

1. In 485 PTZ menu screen, press **CONTROLLER** button to enter Controller setup screen.
2. Press **MODE** button to enter Mode setup screen.

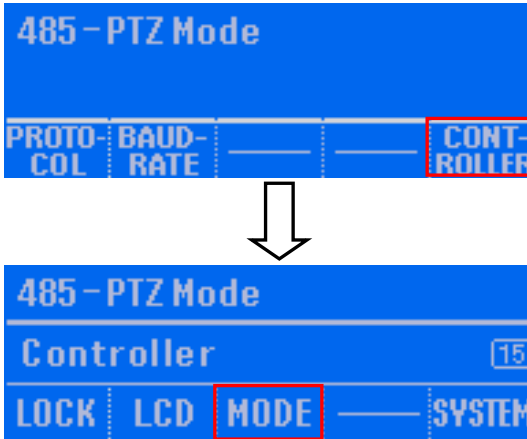

If the password function is enabled, user needs to enter the password for mode switching.

3. In Mode setup screen, press **USB DVR** button to switch the mode to USB DVR mode.

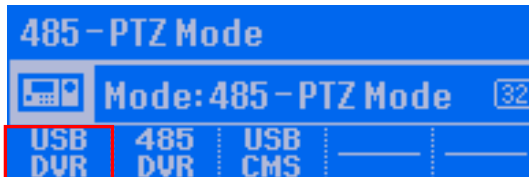

4. Press **OK** button to confirm. To cancel the selection, press **CANCEL** button. When the "Complete" message appears on the LCD screen, the mode switch is completed.



Switching to 485 DVR Mode

When the System Controller is connecting with DVR system through the 485 port, the System Controller mode should be in **485 DVR** modes in order to operate the DVR system. If the mode is not 485 DVR mode, please follow the below steps to switch to 485 DVR mode.



- The default mode is USB DVR mode
- The USB CMS mode is not supported in current version.
- If System Controller is connecting with PTZ camera through RS485 port, please refer to [Operating in PTZ 485 Mode](#) for operation description.

1. In main menu screen, press button to enter Controller setup screen.
2. Press **MODE** button to enter Mode setup screen.

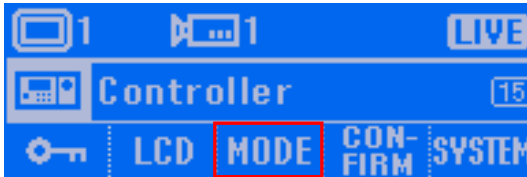

If the password function is enabled, user needs to enter the password for mode switching.

3. In Mode setup screen, press button to switch the mode to 485 DVR mode.



4. Press **OK** button to confirm. To cancel the selection, press **CANCEL** button. When the "Complete" message appears on the LCD screen, the mode switch is completed.



Switch Control on Multiple DVR Servers

System Controller can connect with multiple DVR servers through the RS485 port (see also [Connecting the DVR Server through the RS485 port](#)). Before starting multiple DVR servers control, please switch to DVR485 mode (see also [Switch to 485 DVR Mode](#)).

To make sure the control mode, please press  button and select **LCD**. User should see the current mode show as **"Mode: 485-DVR Mode"**.

To Select an DVR server ID:

1. Press  button on System Controller panel.
2. The LCD screen panel will display the DVR ID select screen as following shown:



3. Using the number keys on the System Controller panel to enter the DVR server ID that user wants to control. And then, press the **Enter** button.



4. Now, the System Controller has switched the control to the ID 1 DVR server.



Familiarizing with LCD Screen

Following will describe the information or icon that display on LCD screen.

■ Main Menu

Current Select Channel Number

1 means channel 1

Current Surveillance Mode

Live is preview mode
Playback is playback mode

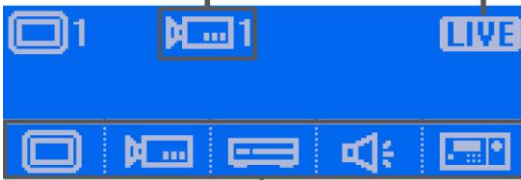

Multi-Function Menu

■ Submenu(Multi-function menu)

Name of function that
user has selected

Display the selection
that user had made
or confirmation infor.

The number indicate what
level of menu and function
that user has selected

11 means menu level 1
and select function 1



Function Selections Menu

Operating the LCD Menu

■ Main Menu

On the LCD screen, each function is corresponding to the button on the panel of the System Controller Pro. To select the function, press the correspond button.

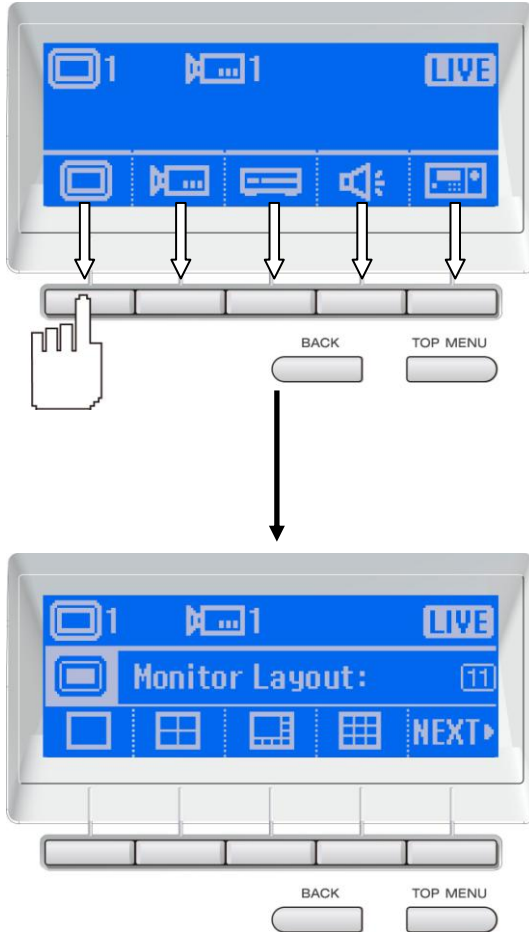

■ **Multi-Function Menu**

In multi-function menu screen, press the correspond button of the selections to configure/operate.

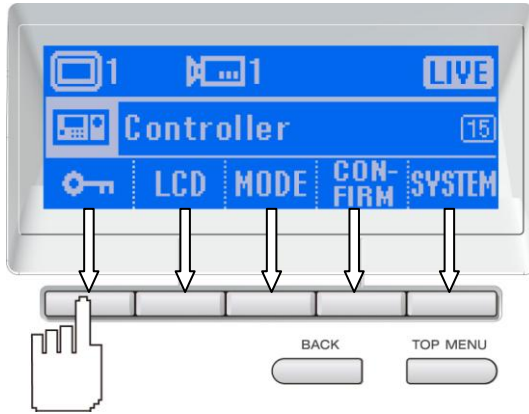

To go back to the main menu, press the **TOP MENU** button. Press the **BACK** button will go back to the previous screen.

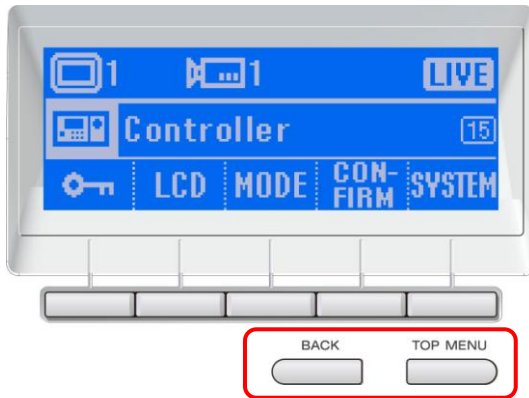

Select a Camera



Select a camera to view, record, or operate.

1. Press  button.
2. On the LCD screen will display **Camera Select** screen.

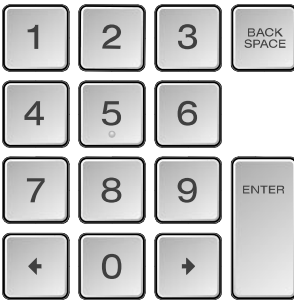

3. Using the numeric key pad to enter the camera number (3 numbers, ex: camera 2, enter 002). After entered the camera number, press **Enter** button to confirm.



Using  &  button can move the cursor to left or right.

4. User should see the camera number will be 3 on the Camera Select screen. Also the surveillance screen of DVR will switch to camera 3.



5. To exit the camera select screen, press **BACK** or **TOP MENU** button.

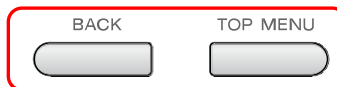

Locking System Operation

Using the lock button () to lock the System Controller for preventing any unexpected situation happen during the operator or administrator is away from the System Controller.

We strongly recommend that enable the password function to enhance the security (see also [Set a Password for System Controller](#)).

1. Press  button. The LCD screen will display "System Controller Locked" message.



2. To un-lock, press  again and using number buttons to enter the password. And then, press **Enter** button to un-lock.



Trigger the Alarm Button

The panic button () allows user to trigger the defined alarm button manually.

1. Press  button and the Alarm Button screen will appear on the LCD screen.



2. Press the number of alarm button to trigger the alarm. When the “**Complete**” message appears on the LCD screen, the alarm is triggered.



3. If the “Failure” message appears on the LCD screen, please make sure the alarm button has been defined. Please refer to the *NV/SA user's manual* for **Alarm Button**'s configuration.

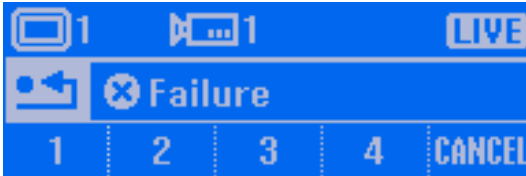

To Playback the Recorded File

To playback the recorded file on surveillance screen.

1. Press  button to switch to playback mode. The LCD screen will display “Playback” message that means the DVR is in playback mode now.



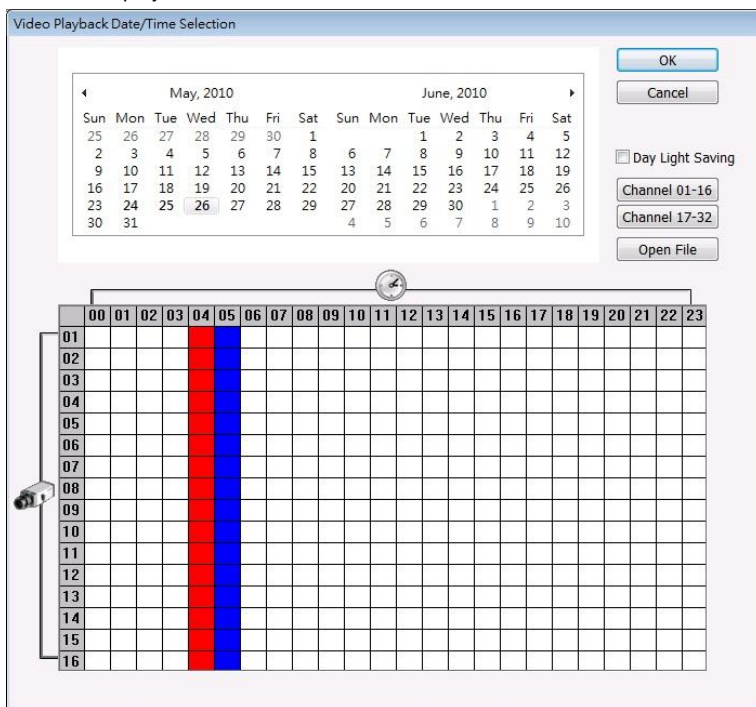

2. The playback time and date selection window will appear on the surveillance screen. Using the mouse or joystick (press the  button to switch to mouse function) to select the time and date that wants to playback.



3. After selected the time and date to playback, the DVR system will start to playback.





4. Using the Jog/Shuttle button to control the playback speed. Press  to enable the Jog/Shuttle button. To disable the Jog/Shuttle button, press  button.

- **Jog dial (top part):** Rotate in clockwise is play at faster forward speed that control by user. Rotate in counterclockwise is rewinding that control by user.
- **Shuttle ring (lower part):** Rotate in clockwise is play at increase speed of 1x, 2x, 4x, 8x, 16x, and 32x. Rotate in counterclockwise is playback at decrease speed of 1x, 1/2x, 1/4x, 1/8x, 1/16x, and 1/32x.

5. To pause the playback, press  button. Press  again to start playback.

To View the Emap

User can select the different Emap to view. The Emap () button is same as the Emap () button on the DVR program UI.

1. Press Emap () button and the Emap UI will appear on surveillance screen.

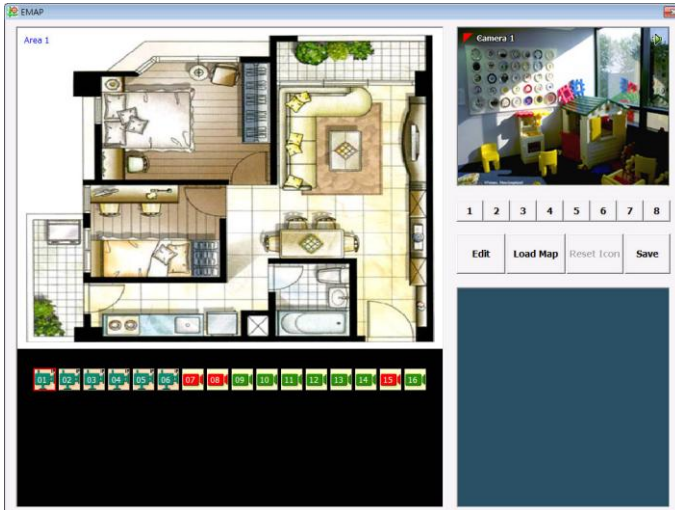

2. On LCD screen, press the Emap number button (1-8) will switch to the Emap that user has selected. Press  button will go to next page of screen.

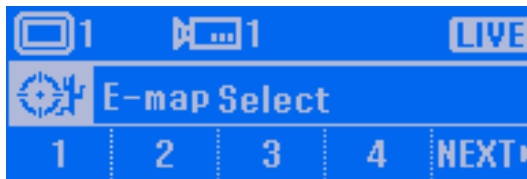

3. To close the Emap UI, press  button, the DVR program will switch back to preview UI.

4. Press **TOP MENU** button to go back to the main menu screen.



PTZ Operation

If the camera has enabled the PTZ function, user can use the System Controller to operate the PTZ camera.



- Please select the PTZ camera before starting PTZ operation. Please refer to [Select a Camera](#).
- When PTZ indicator () is green light up, the PTZ operation is available.

Using the Joystick to Operate the PTZ Camera

The joystick can move the camera to right, left, up, and down and also to zoom in and out of the camera.

■ Panning

Move the joystick to right or left.



■ Tilt

Move the joystick to up or down.





■ **Zoom in/out**

Rotate the joystick to the clockwise side to zoom in and counterclockwise to zoom out.



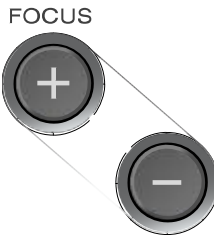

To Focus the Object

Press  button to focus the object in the distance. Press  button to focus the object in nearby.



Adjusting the Brightness of the Image

Press  to adjust the image brighter. Press  to adjust the image darker.

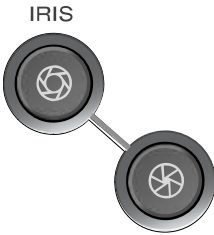

Setup preset position and Use Preset

■ Setup Preset Position

1. Press  button and the Camera preset setup screen will appear on LCD screen.





1. Using numeric key pad to enter the preset position number. The numbers of preset position depends on the support of the PTZ camera.
2. Press **Enter** button to confirm the setting.



2. When the “**Complete**” message appears on the LCD screen, the setting is done.

■ Using the Preset Button

By pressing the  button and enter the preset position number, the camera will move to the preset position that user has setup.

3. Press  button and the Preset position screen will appear on LCD screen.
4. Using numeric key pad to enter the number of the preset position and press the **Enter** button.



5. When the “**Complete**” message appears on the LCD screen, the function is completed.

Enabling the AutoPan

Enable/disable the PTZ camera move automatically that is based on the selected camera group preset position number.

1. Press  button and the AutoPan screen will appear on LCD screen.



2. Press the preset position group number button (1-4, 5-8, 9-12, 13-16) and press  button to start auto pan.

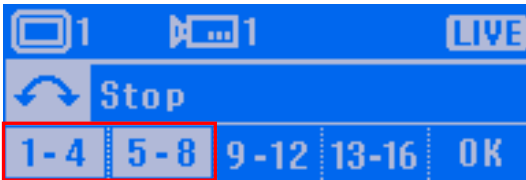

3. When the “**Complete**” message appears on the LCD screen, the function is enabled.

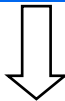

4. To stop auto pan, press selected preset position group number again and press **OK** button. When the **Complete** message appears on the LCD screen, the function is disabled.



Using Digital Zoom

To zoom in the selected screen area for viewing.

1. In single channel screen, press  button. The message "Complete" will appear on the LCD screen that means the digital zoom is enabled.



2. A red frame will appear on the camera screen. Using mouse or joystick (press the  button to switch to mouse function) to click on red frame and drag the area that user wants to zoom in.
3. Right-click mouse or press button on top of joystick to enlarge the selected area.
4. To return to normal view, click on the enlarge area or press button on the top of joystick.

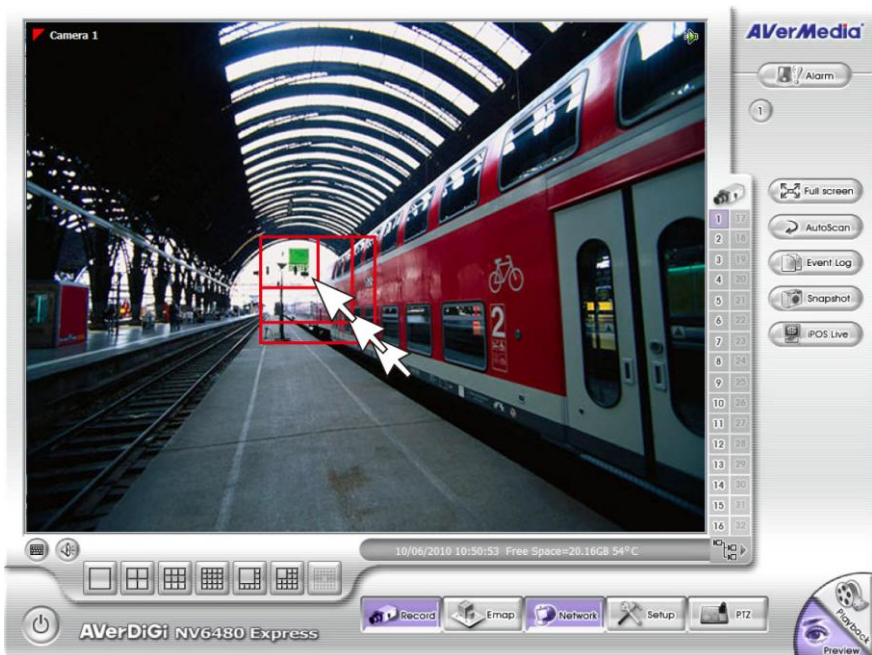

Multi-Functions Menu

In the following sections will introduce the each function's operation.

Select a Monitor Layout

In Monitor Layout, user can select different screen display mode to view. This function is same as split-

screen buttons () on DVR application UI.

There are 7 types of monitor layout -- .

1. Press the  button to enter **Monitor Layout** screen.



2. In Monitor Layout screen, press the button of monitor layout that user wants to view.



3. Press **Next** button to go to next page. To go back to previous page, Press **Prev.** button.



4. The selected monitor layout will be display. The surveillance screen will switch the monitor layout that user has selected.



Camera Setup

In Camera setup, user can enable/disable the camera, enable/disable camera video to be display on the screen, adjust contrast/brightness/saturation/hue, enable/disable de-interlace, and enable/disable relay of the IP camera.



■ Enable a Camera

1. First, select the camera to configuration. Please refer to [Select a Camera](#).





2. At main menu screen, press the  button to enter **Camera Setup** screen.



3. In Camera Setup screen, press  button to enter **Camera Enable** screen.



4. To enable the camera for viewing and recording, press  button. Press  button to disable the camera. When the camera has been disabled, the camera video can't be view and record.



5. When user sees the **“Complete”** message, it means the operation is done.
6. To go back to the Camera setup screen, press **BACK** button. To go back to the main menu screen, press **TOP MENU** button.



■ Enable a Camera View

1. First, select the camera to configuration. Please refer to [Select a Camera](#).





2. At main menu screen, press the  button to enter **Camera Setup** screen.



3. In Camera Setup screen, press  button to enter **Camera Display** screen.



4. To enable the camera video display on the screen, press  button. Press  button to disable the camera. When the camera has been disabled, the camera video will not display on the screen.



5. When user sees the **“Complete”** message, it means the operation is done.
6. To go back to the Camera setup screen, press **BACK** button. To go back to the main menu screen, press **TOP MENU** button.



■ Adjusting the Hue

1. First, select the camera to configuration.
Please refer to [Select a Camera](#).



2. At main menu screen, press the  button to enter **Camera Setup** screen.



3. In Camera Setup screen, press  button to enter **Attribute** screen.



4. In Attribute screen, press  button to enter the **Hue adjustment** screen.



5. In Hue adjustment screen, enter the value number(Range is 0~ 100). After value has entered, press **Enter** button to confirm.





6. When user sees the **“Complete”** message, it means the operation is done.



7. After complete the adjustment, the value of hue will be display on the LCD screen. To go back to previous menu screen, press **BACK** button. To go back to main menu, press **TOP MENU**.



■ Adjusting the Saturation

1. First, select the camera to configuration.
Please refer to [Select a Camera](#).
2. At main menu screen, press the  button to enter **Camera Setup** screen.
3. In Camera Setup screen, press  button to enter **Attribute** screen.
4. In Attribute screen, press  button to enter the **Saturation adjustment** screen.
5. In Saturation adjustment screen, enter the value number (Range is 0~ 100). After value has entered, press **Enter** button to confirm.
6. When user sees the **“Complete”** message, it means the operation is done.
7. After complete the adjustment, the value of hue will be display on the LCD screen. To go back to previous menu screen, press **BACK** button. To go back to main menu, press **TOP MENU**.

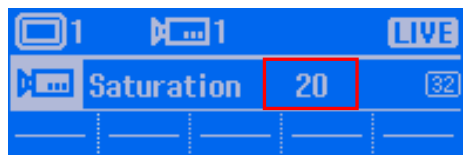
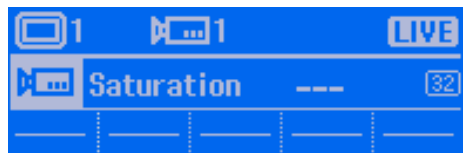
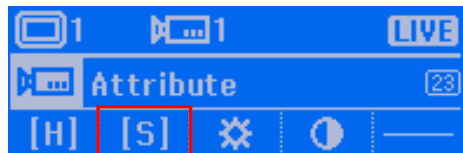

■ Adjusting the Brightness

1. First, select the camera to configuration.
Please refer to [Select a Camera](#).



2. At main menu screen, press the  button to enter **Camera Setup** screen.



3. In Camera Setup screen, press  button to enter **Attribute** screen.



4. In Attribute screen, press  button to enter the **Brightness adjustment** screen.

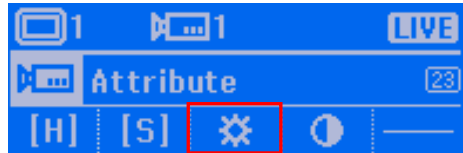

5. In Brightness adjustment screen, enter the value number (Range is 0~ 100). After value has entered, press **Enter** button to confirm.



6. When user sees the **“Complete”** message, it means the operation is done.



7. After complete the adjustment, the value of hue will be display on the LCD screen. To go back to previous menu screen, press **BACK** button. To go back to main menu, press **TOP MENU**.



■ Adjusting the Contrast

1. First, select the camera to configuration.
Please refer to [Select a Camera](#).



2. At main menu screen, press the  button to enter **Camera Setup** screen.



3. In Camera Setup screen, press  button to enter **Attribute** screen.



4. In Attribute screen, press  button to enter the **Contrast adjustment** screen.



5. In Contrast adjustment screen, enter the value number (Range is 0~ 100). After value has entered, press **Enter** button to confirm.



6. When user sees the **“Complete”** message, it means the operation is done.



7. After complete the adjustment, the value of hue will be display on the LCD screen. To go back to previous menu screen, press **BACK** button. To go back to main menu, press **TOP MENU**.

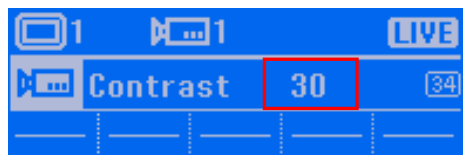

■ Enable the De-interlace

1. First, select the camera to configuration. Please refer to [Select a Camera](#).



2. At main menu screen, press the  button to enter **Camera Setup** screen.



3. In Camera Setup screen, press  button to enter **De-interlace** screen.



4. In De-interlace screen, press **1** button to if you are capturing motionless picture. Press **2** button if it captures lots of movement. To disable de-interlace, press **OFF** button.



5. When user sees the **“Complete”** message, it means the operation is done. To go back to previous menu screen, press **BACK** button. To go back to main menu, press **TOP MENU**.



■ Trigger the Relay of IP Camera

1. First, select the camera to configuration. Please refer to [Select a Camera](#).



2. At main menu screen, press the  button to enter **Camera Setup** screen.



3. In Camera Setup screen, press  button to enter **IP-CAM Output** screen.



4. In IP-CAM Output screen, press 1 ~ 4 button to trigger relay 1~4.



5. When user sees the **“Complete”** message, it means the operation is done. To go back to previous menu screen, press **BACK** button. To go back to main menu, press **TOP MENU**.





Server Setup

In Server setup, user can start recording, stop recording, execute network time synchronization, and call out event log viewer windows.



■ Start Recording

This function is same as press **F2** button (see also [\(9\)Custom Button Function](#) in [Familiarizing with System Controller Panel Buttons](#))

1. At main menu screen, press the  button to enter **Server Setup** screen.
2. In Server Setup screen, press  button to start recording.
3. When user sees the **“Complete”** message, it means the operation is done. To go back to previous menu screen, press **BACK** button. To go back to main menu, press **TOP MENU**.
4. When recording is enabled, the  icon will show up on the surveillance screen.



■ Stop Recording

This function is same as press **F2** button (see also [\(9\)Custom Button Function](#) in [Familiarizing with System Controller Panel Buttons](#))

1. At main menu screen, press the  button to enter **Server Setup** screen.



2. In Server Setup screen, press  button to stop recording.



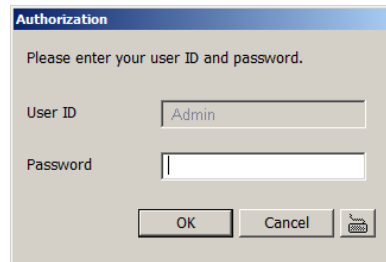

3. The authorization dialog will show up on surveillance screen. Enter the authorize password and click **OK** to stop recording.

The image shows an 'Authorization' dialog box. The title bar is blue and says 'Authorization'. The main text says 'Please enter your user ID and password.' There are two input fields: 'User ID' with the text 'Admin' and 'Password' which is empty. At the bottom, there are three buttons: 'OK', 'Cancel', and a small icon of a server.

■ Network Time Synchronization



To adjust the DVR system time through the network time server that user has configured on DVR server.

1. At main menu screen, press the  button to enter **Server Setup** screen.
2. Please stop recording before start network time synchronization. Press  button in Server setup screen (see also [Stop Recording](#)).
3. After stop recording, press  button to start time synchronization.



■ Open Event Log Viewer

To call out the event log viewer window. This function is same as press  button on DVR program UI.

1. At main menu screen, press the  button to enter **Server Setup** screen.
2. In Server Setup screen, press  button.

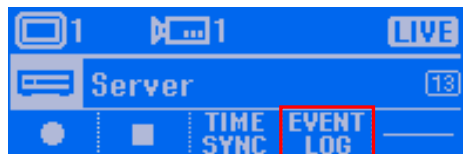



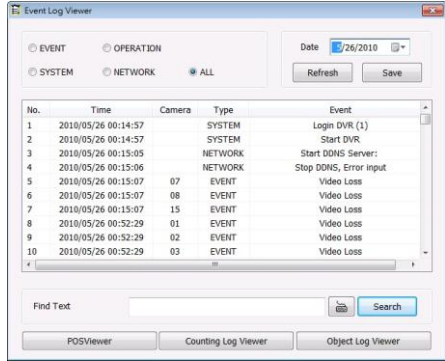

- The event log viewer window will show up on the surveillance screen.





Sound Setup

In Sound setup, user can enable/disable sound and adjust volume of the audio device that is directly connected on System Controller device.

- At main menu screen, press the  button to enter **Sound setup** screen.
- Press s  and  button to increase or decrease the volume.
- To disable the sound, press  button.



- Press  button to complete the setup. To cancel, press  button.



Controller Setup

In Controller setup, user can configure the parameters of the System Controller Pro.



■ Set a Password for System Controller

To setup the password of System Controller for security issue.

1. At main menu screen, press the  button to enter **Controller setup** screen.



2. Press  button to enter System Lock screen.



3. Press  button to enter the Password setup screen.

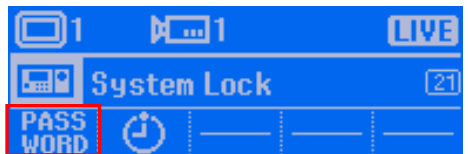
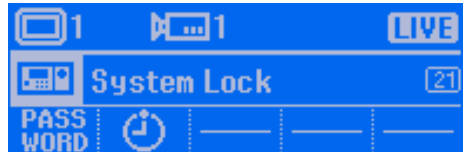

- 4. Press **ON/OFF** button to enable password function.
- 5. The password enter screen will appear. Using numeric key pad to enter the password (6 numbers). After entered password, press **Enter** button.



- 6. When user sees the **Complete** message, it means the operation is done.



■ Change the Password of the System Controller



The password function will be enabling after password changed.

1. At main menu screen, press the  button to enter **Controller setup** screen.



2. Press  button to enter System Lock screen.



3. Press  button to enter the Password setup screen.

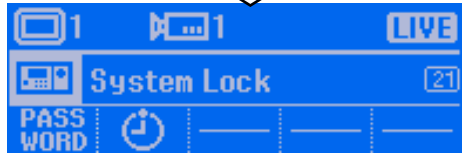

4. Press  button and the Password Change screen will appear.
5. Using numeric key pad to enter the current password (6 numbers). After entered password, press **Enter** button.



6. After entered the current password, the new password screen will appear.

7. Using numeric key pad to enter the new password (6 numbers) and press **Enter** to confirm.



8. After entered the new password, the password confirm screen will appear.

9. Using numeric key pad to re-enter the new password and press **Enter** button to confirm.



10. When user sees the **“Complete”** message, it means the operation is done.



■ Set the Timer

Set a period time for System Controller idling over the setup time to switch to rest status.

1. At main menu screen, press the  button to enter **Controller setup** screen.



2. Press  button to enter System Lock screen.



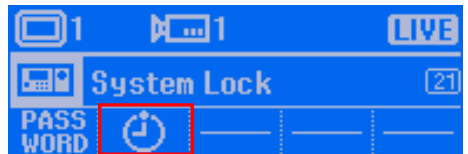
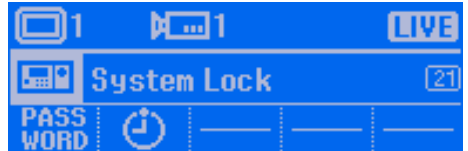

3. Press  button to enter the Timer setup screen.





4. Press  button to enable the timer. Press again will disable the timer.

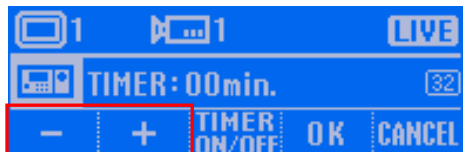

5. Press s  and  button to adjust the time.



6. Press  button to confirm the setting. To cancel, press  button.

■ Adjusting the Brightness of LCD Screen

To adjust the back light brightness of the LCD screen.

1. At main menu screen, press the  button to enter **Controller setup** screen.



2. Press **LCD** button to enter System Lock screen.



3. Press  button to enter the Back light brightness setup screen.



4. Press **+** and **-** button to adjust the brightness. Press **OK** button to confirm the setting. To cancel, press **CANCEL** button.



■ Adjusting the Contrast of LCD Screen

1. At main menu screen, press the  button to enter **Controller setup** screen.





2. Press  button to enter LCD setup screen.





3. Press  button to enter the Contrast setup screen.







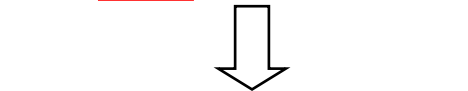

4. Press  and  button to adjust the brightness.



5. Press  button to confirm the setting. To cancel, press  button.



■ Enable/disable Code Number Display

1. At main menu screen, press the  button to enter **Controller setup** screen.
2. Press  button to enter Mode setup screen.
3. Press  button to enter the Code number setup screen.
4. Press  button to enable the code number display. Press  button again will disable the code number display.
5. Press  button to confirm the setting. To cancel, press  button.

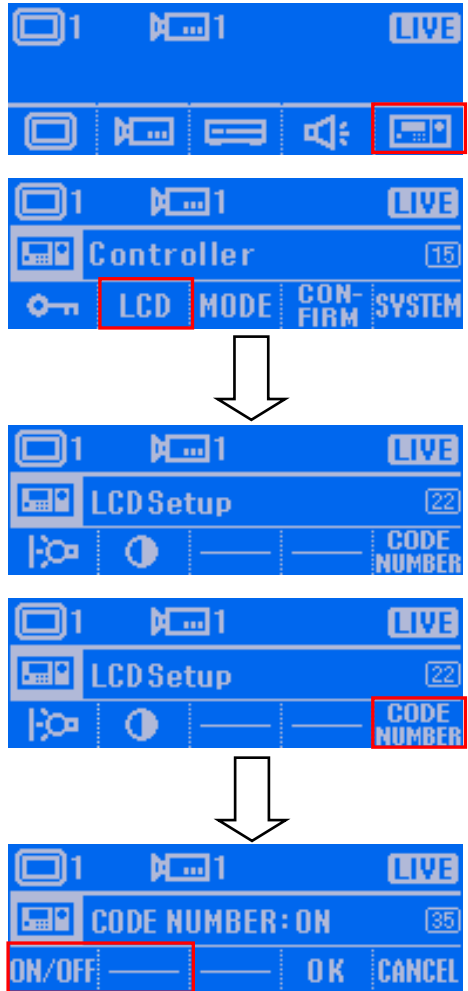

■ Enable/disable Button Confirmation





User can enable/disable to display a confirmation screen when press custom function buttons (F1~F8) and Alarm button.

1. At main menu screen, press the  button to enter **Controller setup** screen.







2. Press  button to enter Button Confirmation setup screen.



3. Press  button to enter Function button setup screen.
4. Press  button to enable or disable the button confirmation function. Press  button to confirm the setting. To cancel, press  button.
5. Press  button again will disable or enable the function.



■ Viewing System Version Information

1. At main menu screen, press the  button to enter **Controller setup** screen.
2. Press  button to enter System Menu screen.
3. Press  button to view current system version. Press  button exit from the screen.

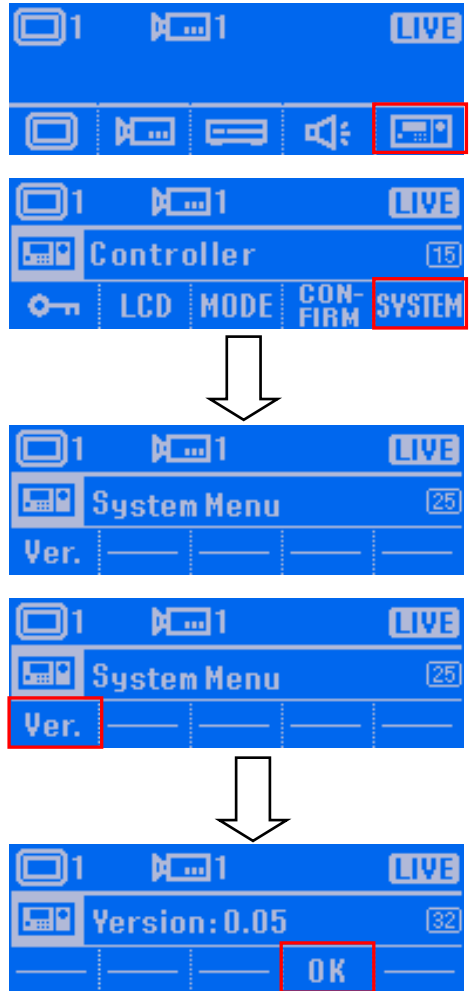

Operating in PTZ 485 Mode



The PTZ 485 mode is to control the PTZ camera that is directly connected with System Controller through the RS485 port.

i To operate PTZ camera, please refer to [PTZ Operation](#).

Switching to the PTZ 485 Mode

Before starting to operate the PTZ camera, please switch to the PTZ 485 mode.

- i**
- The default mode is USB DVR mode
 - The USB CMS and 485 DVR mode is not supported in current version.
 - If System Controller is connecting with DVR system, please refer to [Switching to USB DVR Mode](#) for operation description.

1. In main menu screen, press  button to enter Controller setup screen.
2. Press  button to enter Mode setup screen.

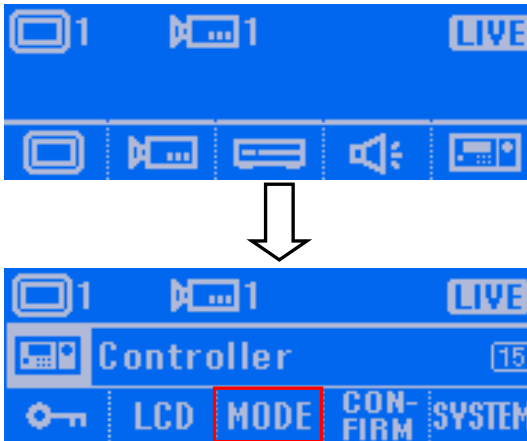

3. In Mode setup screen, press  button to switch the mode to 485 PTZ modes.

i If the password function is enabled, user needs to enter the password for mode switching.



4. Press **OK** button to confirm. To cancel the selection, press **CANCEL** button. When the **“Complete”** message appears on the LCD screen, the mode switch is completed.

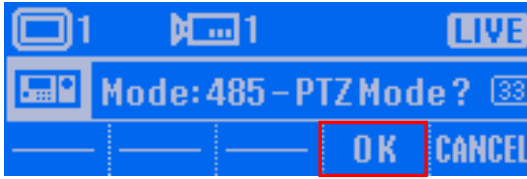

Select the Protocol of the PTZ Camera

Selecting the PTZ camera – Pelco-P or Pelco-D.

1. In 485 PTZ mode menu screen, press **PROTO COL** button to enter the Protocol setup screen.



2. In Protocol setup screen, press **Pelco-D/P** button to select the protocol. And then, press **OK** button to confirm. To cancel the selection, press **CANCEL** button. When the **“Complete”** message appears on the LCD screen, the mode switch is completed.

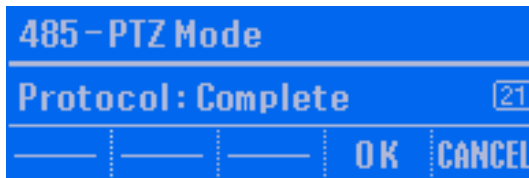
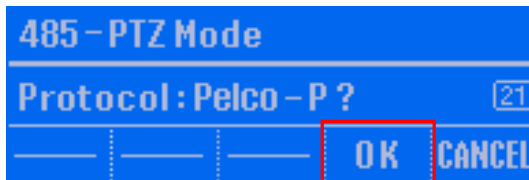
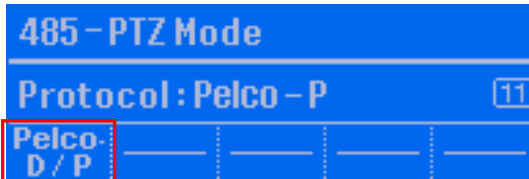

Setup the Baudrate of the PTZ Camera

Selecting the baudrate of the PTZ camera.

1. In 485 PTZ mode menu screen, press **PROTO COL** button to enter the Protocol setup screen.

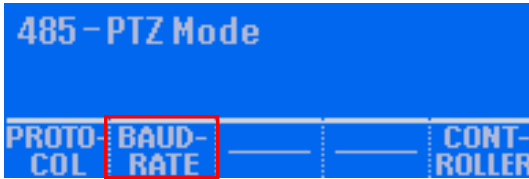

2. In Baudrate setup screen, press baudrate button and press **OK** button to confirm. To cancel the selection, press **CANCEL** button. When the “**Complete**” message appears on the LCD screen, the mode switch is completed.

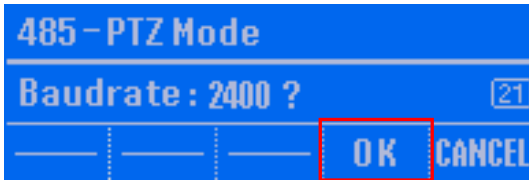

Controller Setup

In Controller setup, user can configure the password, timer, brightness and contrast of the LCD screen, switch mode, and view system version.



■ Set a Password for System Controller

To setup the password of System Controller for security issue.

1. At main menu screen, press the **CONTROLLER** button to enter **Controller setup** screen.

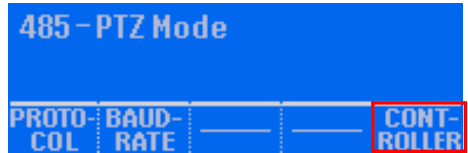

2. Press **LOCK** button to enter Lock setup screen.

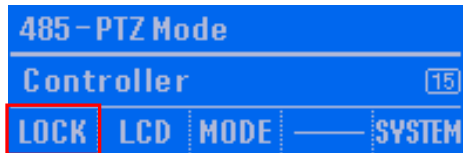

3. Press **PASS WORD** button to enter the Password setup screen.

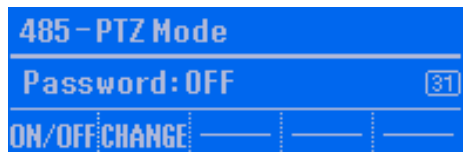

4. Press **ON/OFF** button to enable password function.
5. The password enter screen will appear. Using numeric key pad to enter the password (6 numbers). After entered password, press **Enter** button.

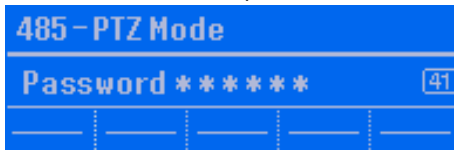
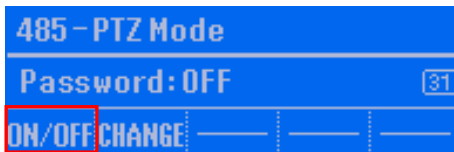

6. When user sees the **“Complete”** message, it means the operation is done.

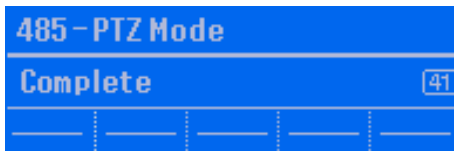

■ Change the Password of the System Controller



The password function will be enabling after password changed.

1. At main menu screen, press the **CONTROLLER** button to enter **Controller setup** screen.



2. Press **LOCK** button to enter System Lock screen.

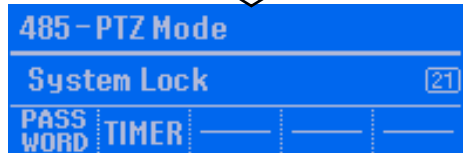
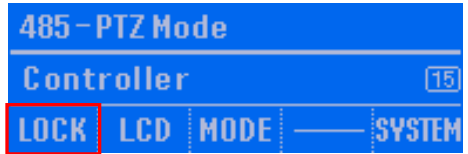

3. Press **PASS WORD** button to enter the Password setup screen.

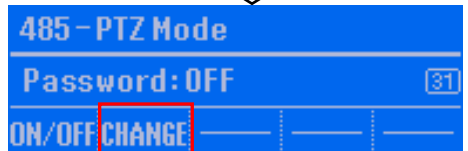

4. Press **CHANGE** button and the Password Change screen will appear.
5. Using numeric key pad to enter the current password (6 numbers). After entered password, press **Enter** button.



- 6. After entered the current password, the new password screen will appear.
- 7. Using numeric key pad to enter the new password (6 numbers) and press **Enter** to confirm.



- 8. After entered the new password, the password confirm screen will appear.
- 9. Using numeric key pad to re-enter the new password and press **Enter** button to confirm.



- 10. When user sees the **“Complete”** message, it means the operation is done.

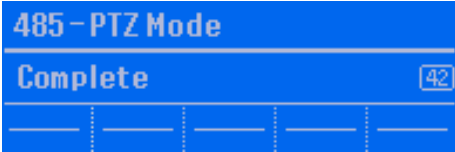

■ **Set the Timer**

Set a period time for System Controller idling over the setup time to switch to rest status.

1. At main menu screen, press the **CONTROLLER** button to enter **Controller setup** screen.



2. Press **LOCK** button to enter System Lock screen.

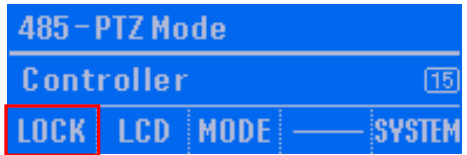

3. Press **TIMER** button to enter the Timer setup screen.

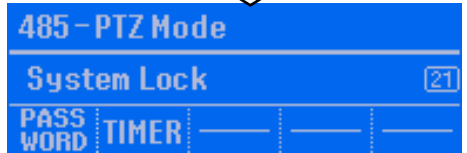

4. Press **TIMER ON/OFF** button to enable the timer. Press again will disable the timer.

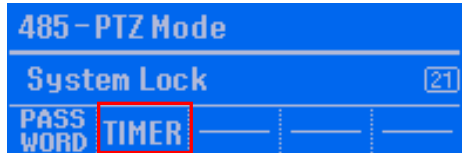

5. Press **+** and **-** button to adjust the time.



6. Press **OK** button to confirm the setting. To cancel, press **CANCEL** button.

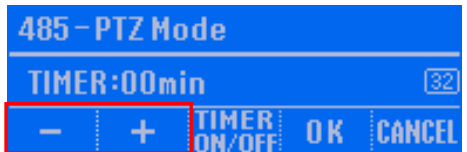

■ Adjusting the Brightness of LCD Screen

To adjust the back light brightness of the LCD screen.

1. At main menu screen, press the **CONTROLLER** button to enter **Controller setup** screen.



2. Press **LCD** button to enter LCD setup screen.

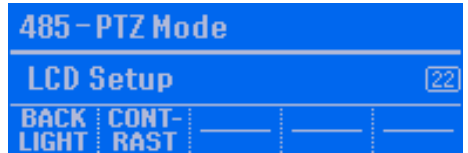
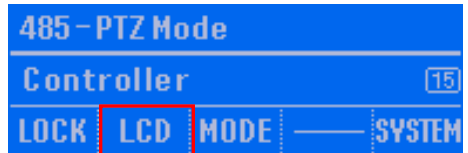

3. Press **BACK-LIGHT** button to enter the Back light brightness setup screen.

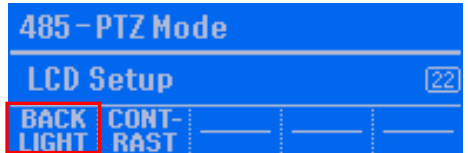

4. Press **+** and **-** button to adjust the brightness. Press **OK** button to confirm the setting. To cancel, press **CANCEL** button.

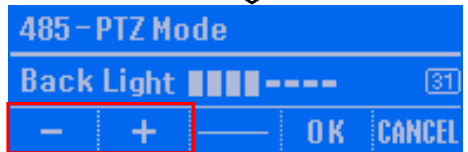

■ **Adjusting the Contrast of LCD Screen**

1. At main menu screen, press the **CONTROLLER** button to enter **Controller setup** screen.

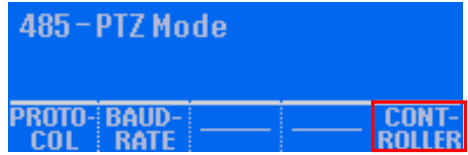

2. Press **LCD** button to enter LCD setup screen.

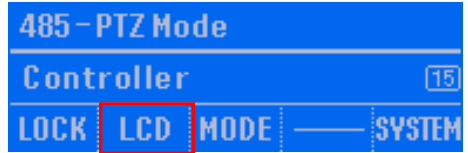

3. Press **CONTRAST** button to enter the Contrast setup screen.

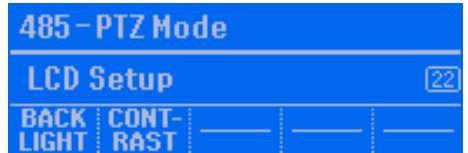

4. Press **+** and **-** button to adjust the brightness.

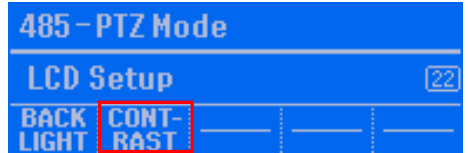

5. Press **OK** button to confirm the setting. To cancel, press **CANCEL** button.



■ **Viewing System Version Information**

1. At main menu screen, press the **CONTROLLER** button to enter **Controller setup** screen.

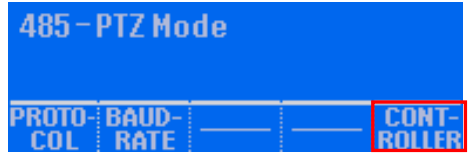

2. Press **SYSTEM** button to enter System Menu screen.

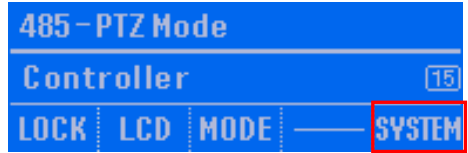

3. Press **Ver.** button to view current system version. Press **OK** button exit from the screen.

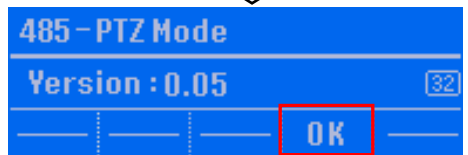
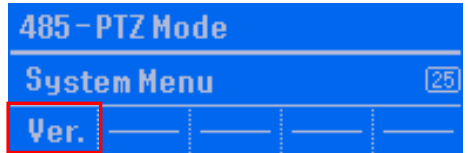
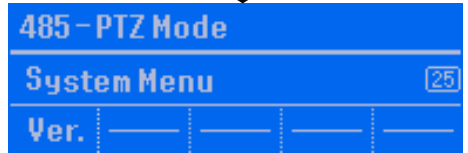

5.2 Camera Setting

In the Camera Setting dialog box, click **OK** to accept the new settings, click **Cancel** to exit without saving, and click **Default1/ Default2** to revert back to original factory setting.

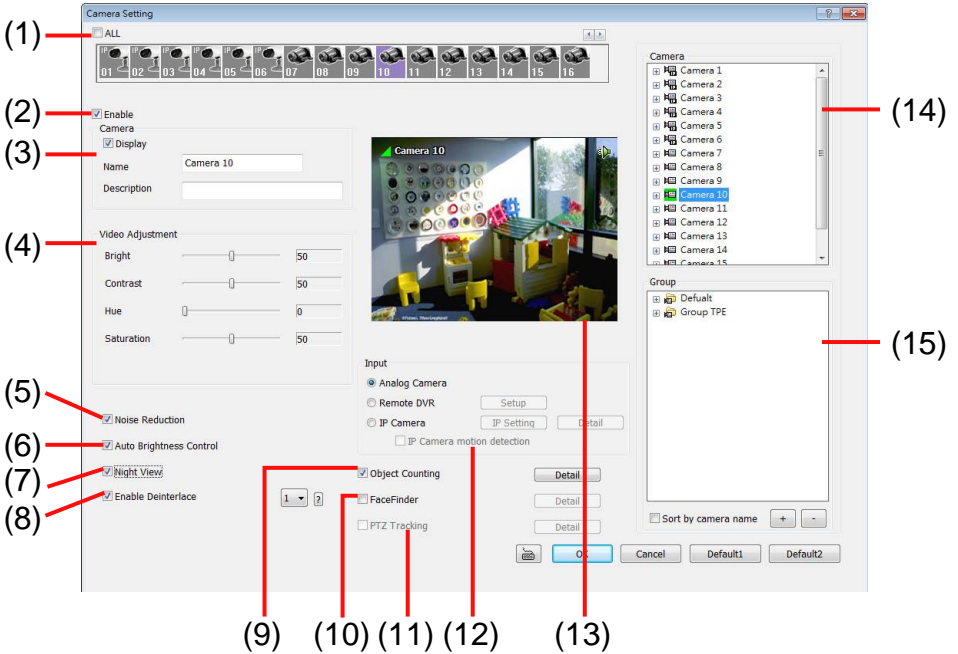

(1) Camera Icons

Select the camera number you want to adjust the video setting. To select all the cameras, enable the **ALL** check box. To select more than one camera, **Right click** on the camera icon. To select one camera only, **Left click** on the camera icon. The camera icon turns red when it is selected. The camera icon will be different that depends on the camera type user selected.



IP camera icon



Analog camera icon

(2) Enable

Set to enable/disable the selected camera. When there is no video source on the camera, we suggest disabling it so that the system won't detect it as video loss error.

(3) Camera

- **Display**
Enable/disable to show the video. Even if the video of the selected camera is hidden you can still record the video and preview it in playback mode.
- **Name**
Change the camera name
- **Description**
Add a short comment

(4) Video Adjustment (*Analog Camera Only*)

Adjust the Brightness, Contrast, Hue and Saturation of the selected camera.

(5) Noise Reduction (*Analog Camera Only*)

Reduce undesirable video single and improve the quality of the video.



Noise Reduction uses lots of CPU resource. Please use this feature only if it is really necessary.

(6) Auto Brightness Control (*Analog Camera Only*)

Automatically adjust the brightness.

(7) Night View (*Analog Camera Only*)

Automatically adjust the exposure to make the image more visible especially when the site is dark. You can only use this function when the Auto Brightness Control is enabled.

(8) Enable Deinterlace

To enhance the video quality. Set the **Enable Deinterlace** mode to #1, if you are capturing motionless picture and #2, if it captures lots of movement.

(9) Object Counting

Select the two regions on the screen and the system will count the objects that appear from one selected region to another selected region. (See also [Chapter 5.2.1](#)).



The DVR system only supports 4 channels for object counting.

(10) FaceFinder

To setup the capture of human face image from live or recorded video(See also [Chapter 5.2.2](#))



The DVR system only supports 4 channels for FaceFinder.

(11) PTZ Tracking

Enable/disable object tracking of the PTZ camera (see also [Chapter 5.2.3](#))



The PTZ tracking only available for the PTZ/IP PTZ camera.

(12) Input

Select the type of video camera input you are using.

- **Analog Camera**
The video source is coming directly from camera that is connected to the NV Series PCI card.
 - **Remote DVR**
The video source is coming from another NV DVR server. In the Remote DVR dialog box, enter the server IP, port number, user ID, password and select the camera number. If you are not sure of the server IP and port, please check the NV DVR server IP address in Network setting.
-



The remote DVR doesn't support audio and PTZ function.

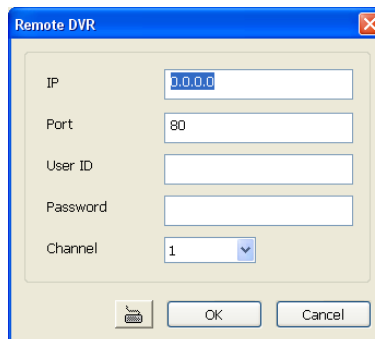

- **IP Camera**

The video source is coming from Network camera or IP camera. Click **Setup** to enter the IP Camera Settings windows.

- ✓ **IP camera motion detection:** Enable to use the motion detection function of IP camera if the IP camera has support motion detection and the motion recording will based on IP camera's motion detection setting.

In the IP Camera Settings dialog box, select to connect using Protocol or URL and then enter the required info. If the IP camera IP address is available, enter the IP address at **IP Camera Site** column. Or User can click **Search Device** to find the selected protocol of camera on the LAN network. If user is not sure the camera is which model, click **Detect Model** to find the correct model of camera. If it requires user identification, enable **Authentication** check box and enter **ID** and **Password**. To enable audio, click **Enable Audio** check box. If you are not sure of the Protocol or URL info, please refer to the IP camera manual or contact your IP camera local distributor. Click **Save & Exit** to save the setting and leave the setup windows, but no connection with IP camera. To connect IP camera, click **Connect** button. Click **OK** to save the setting but not exit the setup windows. To cancel the setting, click **Cancel**.

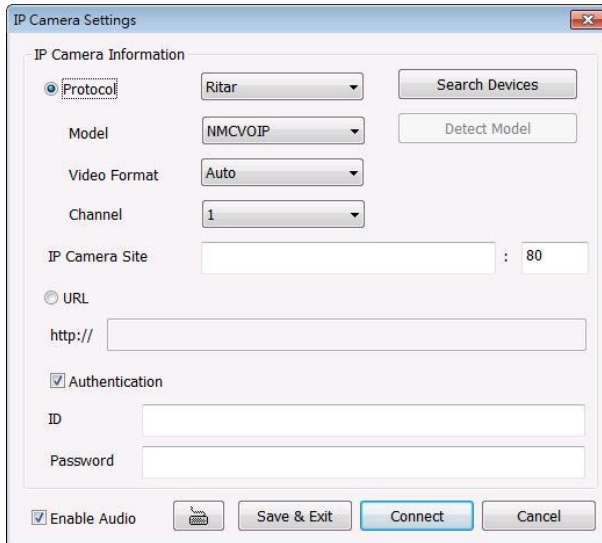

- ✓ **Using RTSP protocol:** If the IP camera supports RTSP protocol, user can select RTSP protocol to connect with IP camera.
 - **Protocol:** Select the “**RTSP_RTP**” from drop-down list.
 - **Model:** Please check user’s manual or vendor of IP camera.
 - **Video Format:** select format of video.
 - **Channel:** Select the channel that is going to be display on the surveillance monitor.
 - **IP Camera Site:** Enter the RTSP URL and port for connection. Please check user’s manual or vendor of IP camera to get RTSP URL and port. Different IP camera has different RTSP URL and port. The example of RTSP URL is “rtsp://10.1.1.2/video.sdp”.
 - **Authentication:** If the IP camera require connection authentication, enable **Authentication** check box and enter **ID** and **Password**.
 - **Enable Audio:** If IP camera supports audio, click it to enable.

Click **Connect** button to connect with IP camera immediately. Click **Save&Exit** button only save the configuration and exit current setup window.

The screenshot shows the 'Add IPCam' configuration window. The 'Protocol' dropdown is set to 'RTSP_RTP'. The 'Model' dropdown is set to 'TCP'. The 'Video Format' dropdown is set to 'Auto'. The 'Channel' dropdown is set to '1'. The 'IP Camera Site' field contains 'rtsp://192.168. .129/h2 /media.am lution' and the port field contains '554'. The 'Authentication' checkbox is checked, and the 'ID' field contains 'admin'. The 'Enable Audio' checkbox is also checked. The 'Connect' button is highlighted in blue.

In Camera Setting interface, click **Detail** to configure more parameters of the IP camera. Click **OK** to save the configuration and exit the setup windows. To reset the configuration back to factory value, click **Default**.

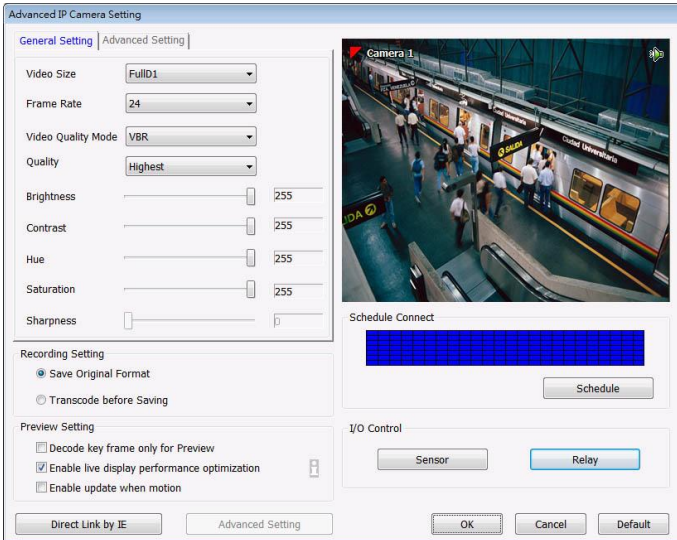

User can select **Video size**, **Frame rate**, **Video** and **Quality Mode** of camera. And scroll the bar to adjust the **Quality**, **Brightness**, **Contrast**, **Hue**, **Saturation**, and **Sharpness** of the camera.

■ **Recording Setting**

- **Save Original Format:** Save the video that is compressed by IP camera's compress mode.
- **Transcode by MPEG4 Encoder:** DVR system is decoding the video and compress video again by using MPEG4 encoder.

■ **Preview Setting:** preview setting will relate to the **Save Original Format**.

- **Decode key frame for Preview:** When previewing video, DVR system only shows key frame and one frame per second.
- **Enable live display performance optimization:** The live video performance will be optimized while display.
- **Enable update when motion:** The video will update only when compare the key frame has motion found, and then, the video will be displayed.

■ **Schedule Connect**

User can select a certain date and time to connect with IP camera. The blue block means connect with IP camera and the white block means disconnect with IP camera. Select the connection status (blue or white) and click the date and time block to set the connection schedule.

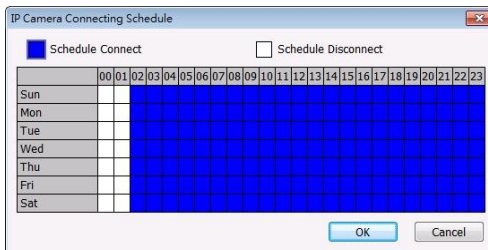

- **I/O Control:** To setup the sensor and relay devices that is installed on IP camera.
 - ✓ **Sensor Setting:** To setup sensor that is embedded on the camera.
 1. Click the drop-down list and select the sensor ID number.
 2. Enter sensor name in **Name** column
 3. The system automatically detects the camera and input relates information. In the Content section, enter sensor description.
 4. In the test section, click **Test** to check the sensor status. **Red** is high and **Green** is low.
 5. Click **OK** to exit and accept the setting and **Cancel** to exit without saving the setting.

Sensor Setting

IPCAM01- Sensor01

Name

Content

Camera 01

Protocol Ritar

Model NMCVOIP

Description

Test

Low Stop

OK Cancel

- ✓ **Relay Setting:** To setup relay device that is embedded on the camera.
 1. Click the drop-down list and select the relay ID number.
 2. Enter relay name in **Name** column
 3. The DVR system automatically detects the camera and input relates information. In the Content section, enter relay description.
 4. In the test section, click **Test** to trigger relay. **Red** is high and **Green** is low.
 5. Click **OK** to exit and accept the setting and **Cancel** to exit without saving the setting.



- **Direct Link by IE:** Using IE browser to connect to camera and view the real time video. Click **Direct Link by IE** , the IE browser will pop up and connect to camera. The video viewing interface will be varied by different brand of camera.

(13) Video Screen

Display the video of the selected camera.

(14) Camera list

List all available cameras for grouping. User can drag the camera to **(13) Video screen** to view camera live video.

(15) Group

User can create several camera groups for managing purpose. All cameras can be group into several different groups (see also [Chapter 5.2.4](#)).

5.2.1 Setup the Object Counting



The DVR system only supports 4 channels for object counting.

1. Click **Detail** to enter the object counting setup window.

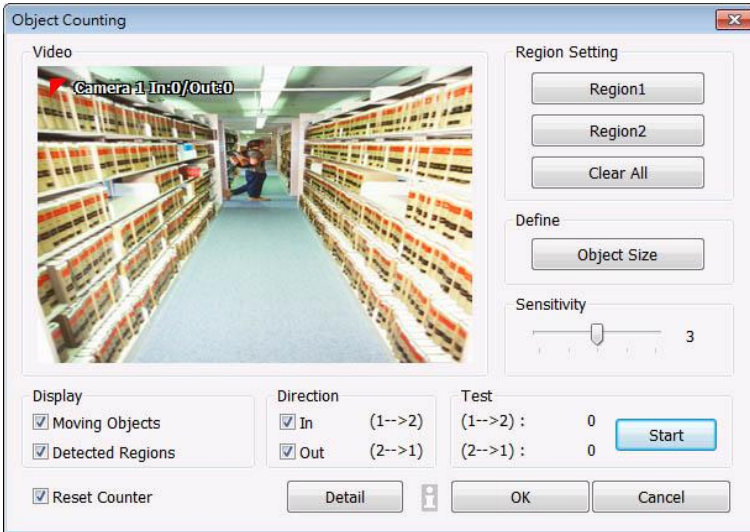

2. Enable **Detected Regions** in **Display** section. This enables the object counting information show on the screen. **Moving Object** will enable the object size frame to show on the screen.
3. Click **Region1** and press left button of mouse and drag the area that user wants the object to be counted. And then, click **Region2** and drag another area that user wants the object to be counted, too. Those selected regions will mark in different color. The system will count the objects that move between the selected regions.
4. Click **Object size** to define the detected object dimensions. Press left button of mouse and drag on the screen. To see the object size frame on screen, enable **Moving Object** in Display section.
5. Adjust the **Sensitive** of object detecting.
6. To test the setting, mark the **Directions (In/Out)** want to be test and click **Start**. The testing result will show in Test section.
7. Enable **Reset Counter** to manual or auto reset counter.
 - ✓ **Auto reset counter:** Select the counter reset by every hour, every 12 hours, or every day automatically.
 - ✓ **Reset the counter now:** reset counter manually.
 - ✓ **Save statistic report after counter reset:** Save the counter data to the **Storage Path** that user has selected.
 - ✓ **Remove data after:** User can delete the counter data in a specific time period. Fill in the **Days** that will delete the counter data after the counter data has been saved in specific storage location.
 - ✓ **Move to:** Save the counter data to another location that user has been selected.

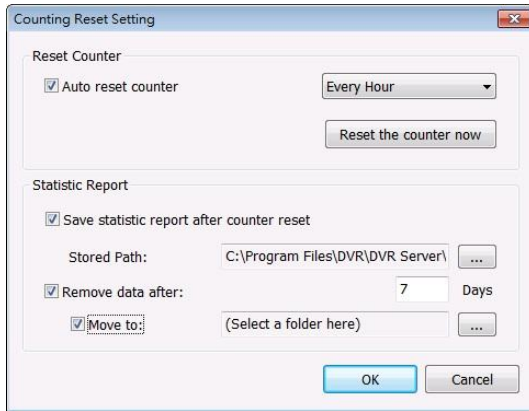

8. Click **OK** to save the setting. Click **Cancel** to leave the setup window without saving.
9. The object counting information will display on the screen of upper part.

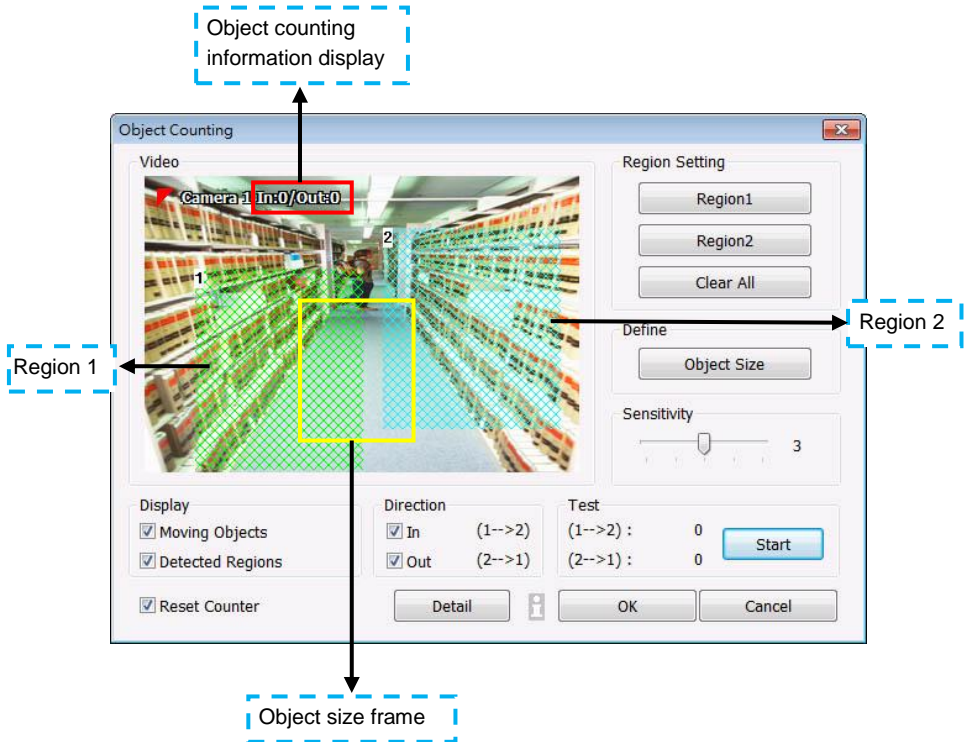

5.2.2 To Setup the FaceFinder

To setup the human face detection and capturing from live and recorded video for security issue. Click **Detail** to enter the FaceFinder setup window. To set the value back to default, click **Default** button.



- The face detection angle is around 30 ~ 45 degrees for both side of face and 25 ~ 30 degrees for look up and down of face.
- It is to recommend that user install the camera in the position of light comes in for better face detection result.

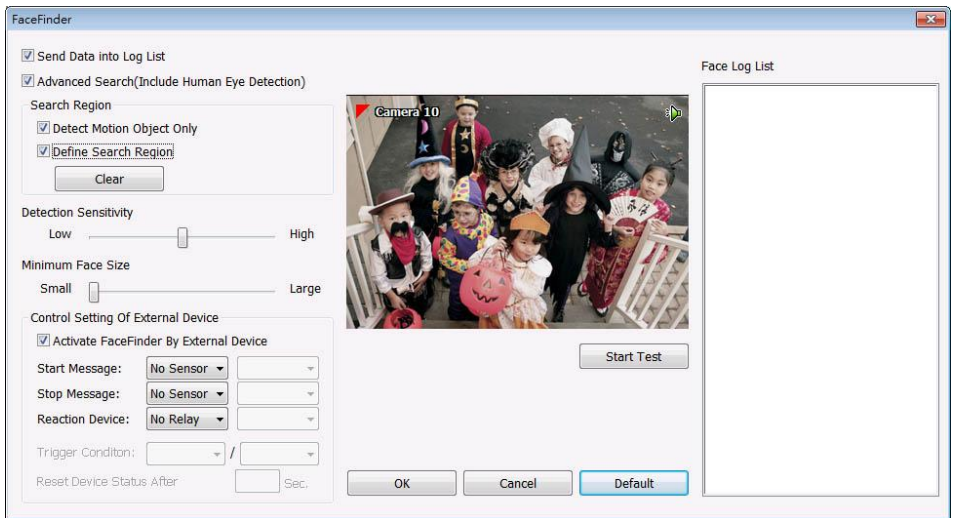

- **Save Data into Object index:** Mark to enable face detecting and capturing face image to display on face object log. The default is enabled when the FaceFinder is enabled.
- **Advanced Search(Include Human Eye Detection):** Beside face recognition, the system will also focus the detection on eyes of face.
- **Search Region:** User can select condition of face detection and setup face detects area.
 - **Detect Motion Object:** Only when the human face is moved, the system will detect and the face will be captured.
 - **Define Select Region:** Setup the face detects area. The system will only detect the face in the selected area. On the preview screen, use mouse to drag the area that user wants to search. User should see the blue frame on the preview screen of FaceFinder setup window. User can select multiple areas for detection. To clear the selected area, right click the mouse button and drag the selected area to clear. Or, click **Clear** to clear all selected areas.
- **Detection Sensitivity:** To set the sensitivity level of face detection. More higher is more easily to detect the difference of the face.
- **Minimal Face Size Level:** To set the face detection of minimal size. The system will only detect the face size is equal or bigger than the minimal face size. User should see a green frame on the preview screen of FaceFinder setup window.

- **Control Setting of External Device:** Set the conditions of the face detection that is trigger by outside device such as sensor, relay device.
 - **Activate FaceFinder By External Device:** Mark to enable trigger condition.
 - **Start Message:** Set the sensor level that will trigger the face detection. The default is high.
 - **Stop Message:** Set the sensor level that will reset the condition of face detection. The default is low.
 - **Reaction Device:** Set the activate level of relay device. When the face detects condition meets the condition in **Trigger Condition**, the relay will send out the signal and the system will send out the face object log. The log can be viewed in Face Object Log.
 - **Trigger Condition:** Set the condition for activating relay device to send out the log to DVR system. Select the time (second) and times (the number of face has been detected) from drag down list.
 - **Reset Device Status After:** Set the time period to reset activate device back to normal status. It works only when the activate status is set to trigger.

After set up, click **Start Test** to test the configure result. When the system is detecting face, the red frame will show up on the screen. The test result will display in Face log List windows as below figure shown:



5.2.3 Setup PTZ Tracking

PTZ tracking allows user to setup a select range for PTZ camera to tracking the object automatically when object is out of selected rage.



The PTZ tracking will be available when the camera is enabled PTZ function.

1. User need to enable the PTZ function of the camera if the camera is a PTZ/IP PTZ camera.(see also [Chapter 4.13](#))
2. Click **Detail** from the Camera Setting windows.
3. Configure the following selections to complete the PTZ tracking.

(1) Show Trigger Line in Live Video: Enable/disable the tracking line on the preview screen.

(2) Left Trigger Line(red line): Set the left edge of the tracking range. If the object is out of the range edge, the camera will automatically move to track the object.

(3) Right Trigger Line(red line): Set the right edge of the tracking range. If the object is out of the range edge, the camera will automatically move to track the object.



(4) Maximum Size(green frame): Set the maximum size of the object for detection.

(5) Minimum Size(green frame): Set the minimum size of the object for detection.



(6) Enable PTZ Auto Tracking: To restore PTZ tracking function after the camera has been manually control. The PTZ tracking will stop function when user has operated the PTZ camera manually. Therefore, user can enable this option to make sure the PTZ tracking will be restored after manually control of the PTZ camera.

(7) Go to PTZ Preset Position: To move the PTZ camera back to the selected preset position after PTZ camera tracking the object and the object is missing or out of the camera view.

- ✓ **Set Speed:** To set the moving speed of PTZ tracking. If the direction button moving speed of PTZ control panel has changed, the moving speed of PTZ tracking will be follow the speed of the PTZ control panel. Otherwise, PTZ tracking's moving speed will based on the speed that user has set in PTZ tracking setting.



4. Click **OK** to complete the setting.
5. When the PTZ tracking has been setup, user should see the PTZ tracking icon () on the preview screen.

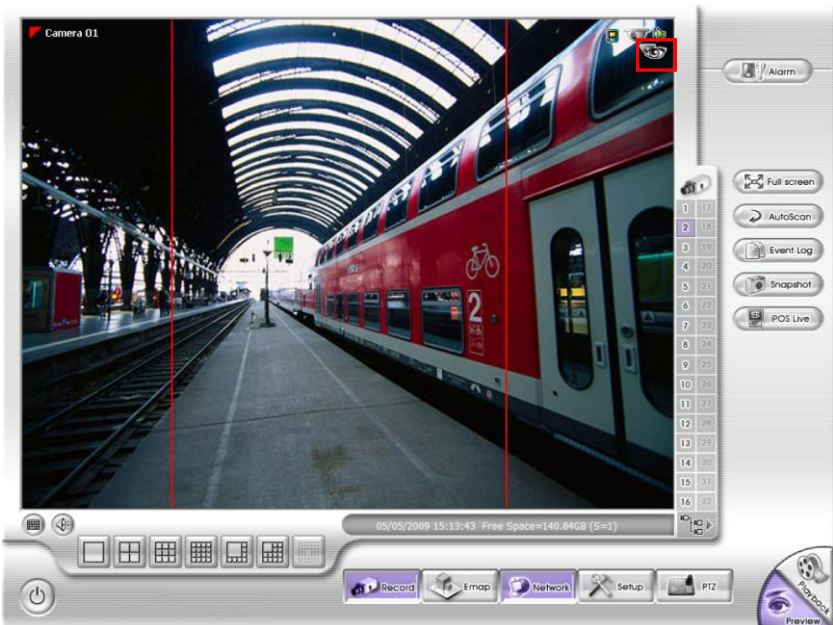

5.2.4 Create a Camera Group

Follow the below steps to create a camera group. The maximum of group number is 64. The default group can be deleted and modified.

1. Click  to add a new group.

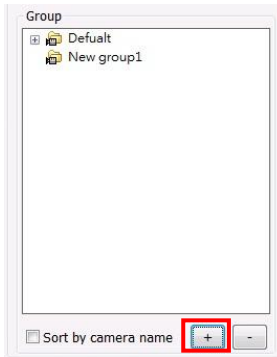

2. Right-click on group to rename the group name.

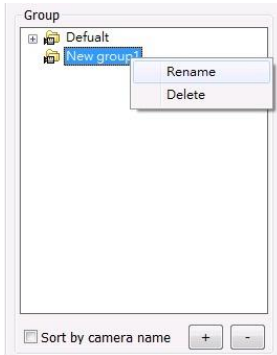

3. Drag the camera from Camera list section to the group.

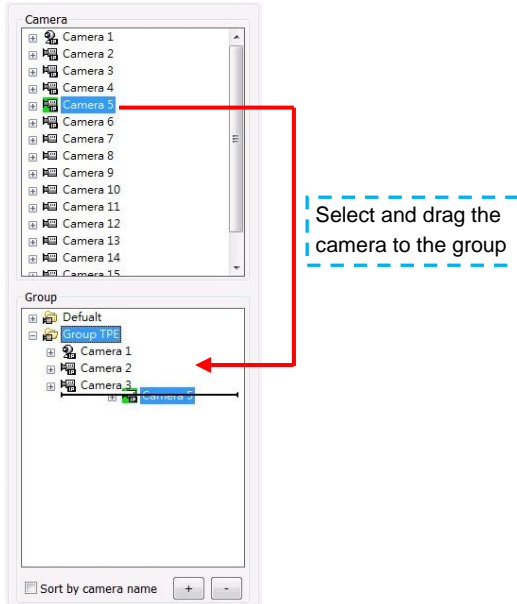

4. Right-click the camera can rename, delete, display/no display video of camera, and enable/disable camera.
5. To add another group, do the step 1 to 4 again.
6. To delete the group, click or right-click the group and select delete.
7. Mark **sort by camera name** to display group by name order.
8. Click **+** of the group to extend the group. Click **+** of the camera to view all devices that is connected with camera. Right-click the camera, user can change name of camera, disable/enable the camera, display/no display the video of the camera, or delete the camera from group from short-cut menu.

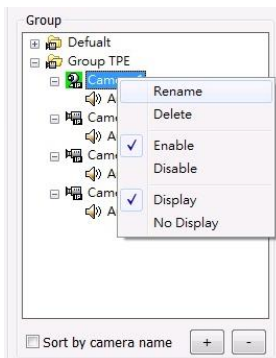

9. User can easy to view and manage the camera group in preview/advanced mode by click camera tree icon (see also [Chapter 4.3\(11\) Camera Group Tree](#)). From camera group tree, user can enable/disable, display/un-display, and rename the camera and enable/disable the audio of the camera.



To manage the camera group tree in preview/advanced mode, user need to be enabled the **Group Tree Menu** control right in account setting(see also [Chapter 5.9 User Setting](#))



5.3 Recording Setting

In the Recording dialog box, click **OK** to accept the new settings, click **Cancel** to exit without saving, and click **Default** to revert back to original factory setting.



Some of functions will not be available when the camera type is an IP camera.

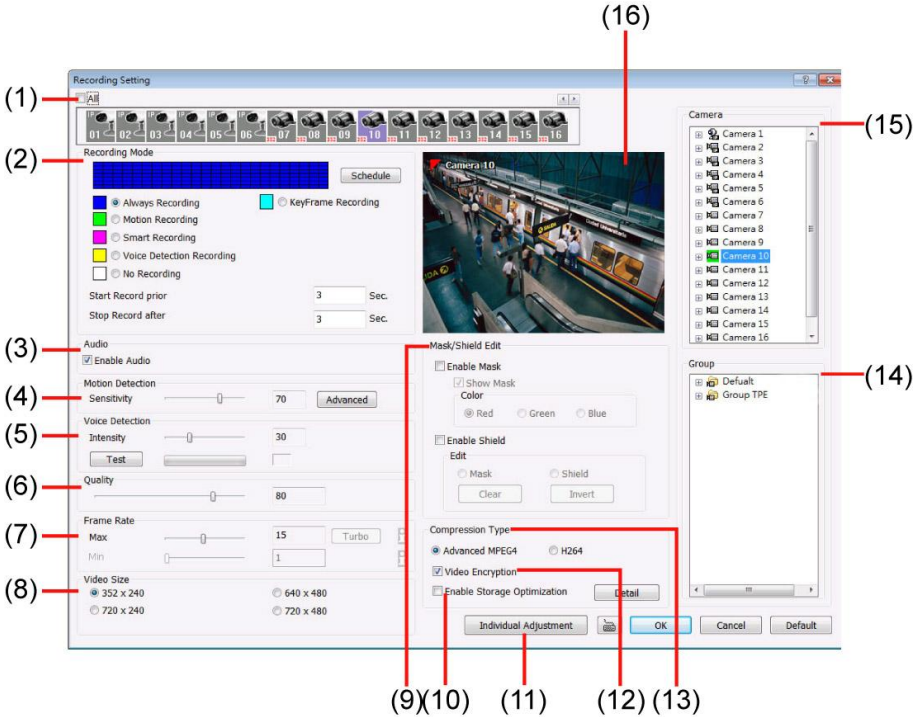

(1) Camera Icons

Select the camera number you want to set the recording setting. To select all the cameras, enable the **ALL** check box. To select more than one camera, **Right click** on the camera icon. To select one camera only, **Left click** on the camera icon. The camera icon turns red when it is selected. The camera icon will be different that depends on the camera type.



IP camera icon



Analog camera icon

(2) Recording Mode

The horizontal blocks from 00 to 23 represent the time in 24-hour clock and the vertical block 1 to 7 represent the day in the week block (Sunday to Saturday). To record in full 24 hours and 7 days a week, select the recording mode and click the **⊙** button. If you want to only record at a particular time or day, click **Schedule** button and select the **Recording Mode**, and then click on the time or day blocks. When the system starts recording a red triangle mark would appear at the upper left corner of the screen.

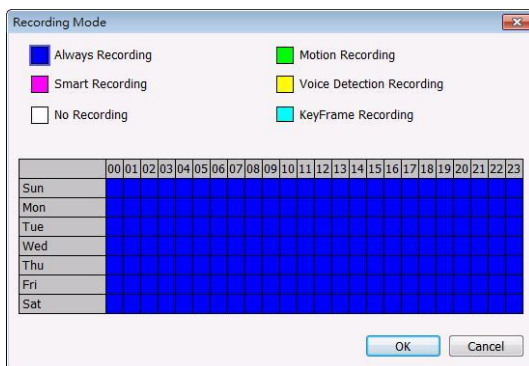

The recording modes are listed below:

- **Always Recording**
Record the video from the selected camera and save it to the designated storage path (see also [Chapter 5.1 #1](#)).
- **KeyFrame Recording**
Only record one frame per second.
- **Motion Recording**
Start recording the video from the selected camera only when the system detects movement. Once a motion is detected, the system automatically saves the previous frames and stop based on the **Start Record Prior** and **Stop Record After** settings.

- 
 - When camera is Analog or IP camera and recording resolution less or equal to D1, the DVR system only record in key frame for pre-recording.
 - When camera is Mega-pixel IP camera and the recording resolution is greater than D1, the DVR system won't do any pre-recording.

- **Smart Recording**
Automatically switch to recorded at the maximum frame rate setting once a motion is detected and if there is no motion, it records at the minimum frame rate setting. Set the maximum frame rate setting in [\(7\) Frame Rate](#).
- **Voice Detecting Recording**
DVR system will record when the voice exceeds the intensity value in **Voice Detection** setting.
- **No Recording**
The system won't do any recording.

(3) Enable Audio

Select to assign the audio channel of the selected camera. You can only assign one audio channel to one camera source. This way you can record both audio and video.

-  An Audio I/O card is required to use this function.

(4) Motion Detection

Adjust the sensitivity of the motion detector. The higher the value, the finer the sensitivity is detected. When it detects a motion, a green triangle mark would appear at the upper left corner of the screen. Click **Advanced** button to select the area for motion detection. Click **Region 1/2/3** button, and then, click-and-drag an area on camera screen for motion detect. To adjust motion detect sensitive, scroll the **Sensitivity 1/2/3** bar. Click **OK** to save and exit the setting window. To reset all setting, click **Default**.

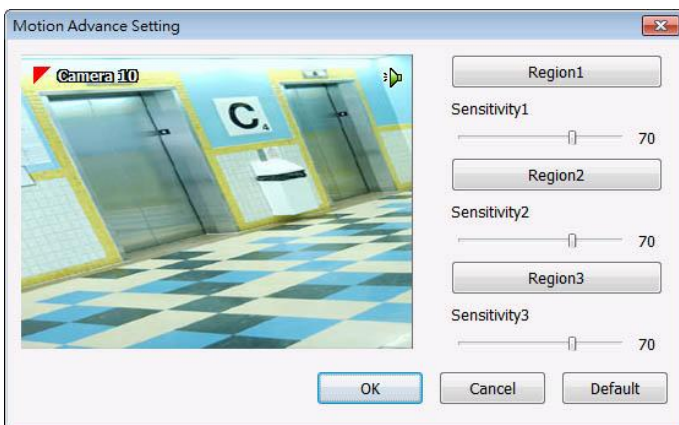

(5) Voice Detection

Adjust the intensity of the audio detector. The system detects sound when it exceeds the intensity value. Click **Test** button to test the voice detection setting.

(6) Quality

Adjust the video quality. The higher the value, the lower the compression level and uses more hard disk space.

(7) Frame Rate

Set the maximum and minimum number of frames to be recorded during motion and motionless state. The frame rate ranges from 1 to 30 for NTSC and 1 to 25 for PAL. The higher the frame rate, it uses more hard disk space. The **Turbo** function will be available when using 2 NV6480E card.

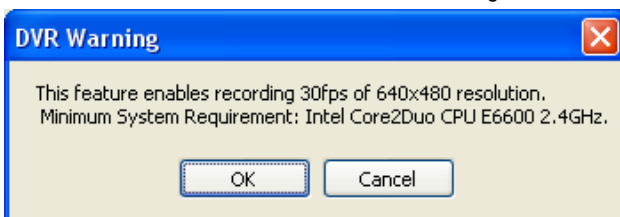

- For NV6480T card (16 channels), DVR system can record 30 frames in D1 mode when only enable the first 8 channels.
- For NV6240T card (16 channels), DVR system can record 15 frames in D1 mode when only enable the first 8 channels and records 30 frames in D1 mode when only enable the first 4 channels.
- For NV6240T card (8 channels), DVR system can real time recording in D1 mode for all 8 channels.
- Above flexible recording frame rate is only available when using NV6000T series hardware version B or above (hardware version A is not supported with flexible recording frame rate). You can press F1 in DVR system to check the hardware version of your NV6000T card.
- NV8416T supports 32 channels real time recording, please refer to [Chapter 2.1](#) for hardware requirement of 32 channels real time recording.
- To enable and disable cameras, please go to **Camera setting**.

(8) Video Size

Select the size of the video and click the  button. The higher the size, the larger the file it create. Y

(9) Mask/Shield Edit

Mask, mark an area on the screen to disregards the motion in the marked area and to only monitor outside the marked area. As for the Shield, it covers an area on the screen and the covered area would not be visible on the screen and recorded. (see also [Chapter 5.3.1 and 5.3.2](#))

(10) Enable Storage Optimization

Enable/disable to save more storage space. Click **Detail** button to select the type of storage optimization.

- ✓ **Monochrome Mode:** The video will record in black and white.
- ✓ **Noise Reduction:** To do the noise reduction before compression.
- ✓ **Disable Video Enhancement:** To shutdown video enhancement function.

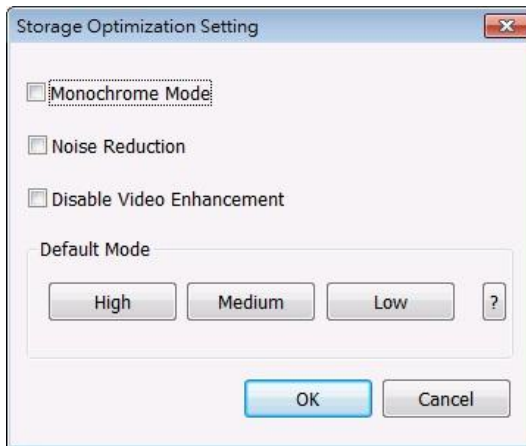

User also can select the Default Mode High/Medium/Low. Click ? button to view default mode definition.

(11) Individual Adjustment

To adjust recording frame rate of each channel. **Max available frames** are total frames that can be used. Each channel shares Max available frames equally except the channels are IP camera. **Used frames** are the frames that have been used. Select the **video size** and scroll the bar to adjust **frame rate** of camera. Click **OK** to save the configuration. To cancel, click **Cancel**.



Only supports on NV7000 series and 8416T.

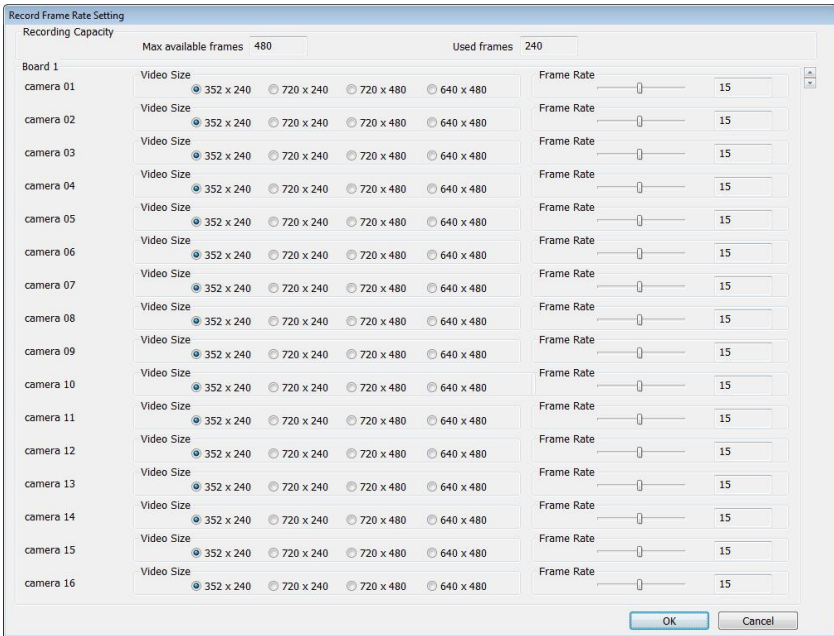

(12) Video Encryption



When NV7480 card has enabled one channel encryption, the all channels will be encrypted.

Enable/disable to encrypt the recorded video that way only the person who knows the password can clearly view the video playback. The file size would become 10 to 30% more. Enabling the Video Encryption check box, you will be prompted to enter the password and retype the password for confirmation. Make sure not to forget the password for you would not be able to decrypt the video without it.



The  symbol would appear on the upper right corner of the encrypted video screen. You may see the video during live recording. To decrypt the video, please refer to [Chapter 5.3.3](#).



(13) Compression Type

Select from 3 compression types. User can refer the table below to check the NV card supports what type of compression. H264 is the latest and advanced video compression format that delivers better video quality and smaller file size but this uses more CPU resource. Advanced MPEG4 and MJPEG, both provide a standard for color picture compression rate. MPEG4 uses higher compression rate and smaller file size. While MJPEG uses slightly lower compression rate and bigger file size.

	MPEG4	MPEG 4 Encryption	H264	H264 Encryption	MJPEG
NV3000T	✓	✓	✓	✓	✓
NV5000T	✓	✓	✓	✓	✓
NV6000T	✓	✓	✓	✓	
NV7240	✓				
NV7480	✓				
NV8416T	✓		✓		
NV9416T			✓		

(14) Group

Click to view the camera group that user has been setup in **Camera setup** (see also [Chapter 5.2.4](#)).

(15) Camera

Click to view the camera live video on **(16) Video Screen**.

(16) Video Screen

Display the video of the selected camera.

5.3.1 To Mask/Shield an area on the screen

1. In the Mask/Shield Edit section, activate the **Enable Mask/Enable Shield** check box.
2. In the Edit section, select between Mask or Shield and click the ⊙ button.
3. Click and drag a frame on the **(9) Video Screen** to create Mask or Shield area.

5.3.2 To show and change the color of the Mask

1. Enable the Show Mask check box.
2. In the Color section, select the color and click ⊙ button.

5.3.3 To Playback Encrypted Video

On Playback, Webcam, and Remote Console video screen, just click  and enter the correct password to decrypt and playback the video.

To encrypt the recorded video back, click  and enter a **WRONG** password.



It is important to encrypt the video again, to avoid unauthorized user viewing the video.

5.4 Network Setting

In the Network Setting dialog box, click **OK** to accept the new settings, click **Cancel** to exit without saving, and click **Default** to revert back to original factory setting. For the network service ports that use by DVR server, please see [Appendix C](#).

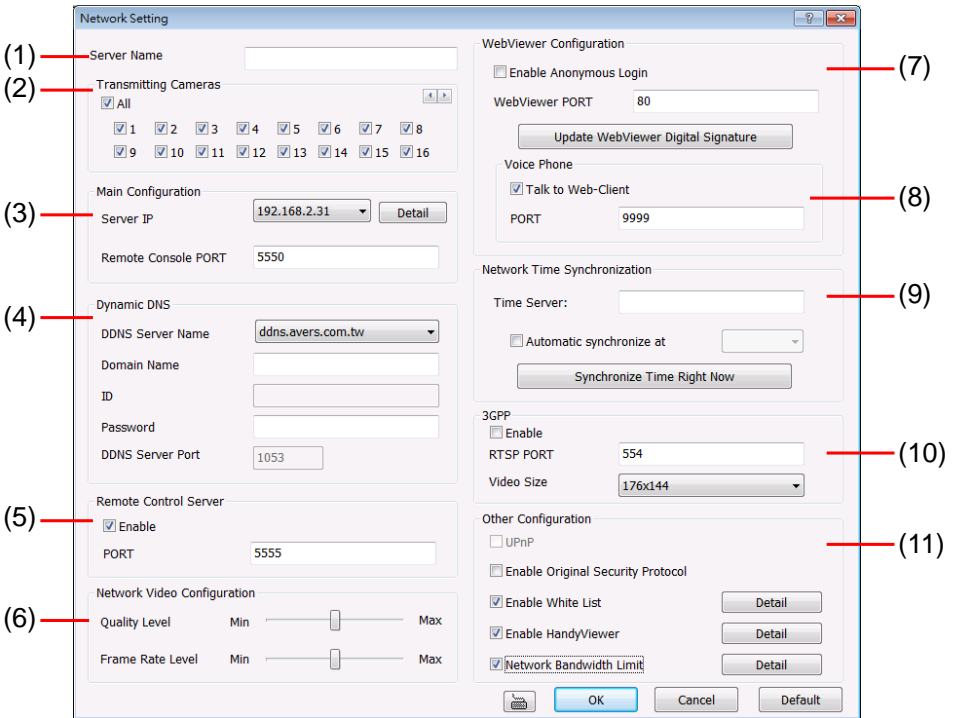

(1) Server Name

Assign a name for the DVR unit. Alphabet letters and numbers only.

(2) Transmitting Cameras

Select and click on the camera number in the Transmitting Camera section you want to make it accessible via internet using WebViewer, Remote Console, PDA Viewer and Hand Viewer (still image). To select all the cameras, enable the **ALL** check box.

(3) Main Configuration

Set the Server IP and Remote Console Port number. The system will automatically detect your Server IP address. You need this when accessing NV DVR server from the remote location via internet. To change the IP address of DVR server, click **Detail** button.

(4) Dynamic DNS (Domain Name System)

Use this service if the IP address changes each time when you connect to internet. Enter the **Domain Name** and **Password** that user has registered, select the **DDNS Server Name** which the one that user had registered the domain name, and enters the **DDNS Server Port** that is a service port for connecting with the DDNS server.

To use this feature, please go to <http://ddns.avers.com.tw> or <http://www.dyndns.com> (see also [Appendix A](#)) to register your own domain name.

(5) Remote Control Server

Enable/disable remote control from remote application (ex. CM3000). Enter the remote accessing port in **Port** column. The default value is 5555.



User also can manually run this function. To run, click **Start > Programs > DVR > Web Tool > Remote Control Server**. The  remote control server icon appears on the taskbar when the remote control server is enabled. (also see [Chapter 12](#))

(6) Network Video Configuration

Set up the video quality and frame rate for viewing and transmitting to the remote program. Scrolling adjust bar to set the **Quality level** and **FrameRate level**.

(7) WebViewer Configuration

Activate **Enable Anonymous Login** to remotely access the DVR server without the need of password

(8) Voice Phone

The **Talk to Web-Client** is to use the 2-Way Talk feature that allows the client and server to talk via internet using microphone. Make sure both microphone and speakers work before using this feature. If the **Talk to Web-Client** is disabled, the person in the NV DVR server side can only hear the voice from the client side that is when the WebCam 2-Way Talk button is activated. (see also [Chapter 8.1 #6](#)).



Make sure that your Webcam Digital Signature is updated yearly; else you won't be able to access the NV DVR server from the NV DVR WebViewer. To update/download your WebViewer Digital Signature, click **Update WebViewer Digital Signature**. Make sure your PC is connected to internet.

(9) Network Time Synchronization

Adjust the NV DVR system time same as network time server. Fill in the **Time Server** IP address or domain name. Select **Automatic Synchronize** time to set automatic synchronize time on a daily basis. Or, user can click **Synchronize Time Right Now** to adjust time right away.

(10) 3GPP

Enable 3GPP that allows user to use browser on the mobile phone to view recorded video. Just enter <http://DVR Server IP/3GPP> on the browser of mobile phone, and then, user will receive the recorded video from DVR server. Fill the RTSP PORT for 3GPP connection. Select the video size for transmitting to user's browser on the mobile phone.

(11) Other Configuration

- UPnP

Enable UPnP function to automatically configure the port setting of DVR to the router on the local network. This function is available when the router has enabled the UPnP function. The DVR port information will automatically write into the router or other network device (see [Appendix B](#)).

- Enable Original Security Protocol

Enable DVR system to accept the connection from former version of remote access application. For example, if user uses CMS version 7.1 and connect to DVR server with version 7.3, and then, user has to enable this option to make it work. It is due to that DVR system has new security protocol and it's not compatible with old remote access software.

- Enable White List

An access permit list for the remote accessing of NV DVR server. Enter the IP address and click **Add**. Or, enter a range of IP address and click **Add**. To delete the IP from the list, select the IP and click **Delete** button. To reset the input, click **Clear** button.

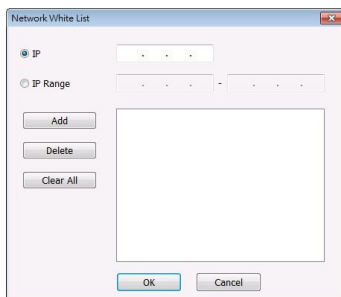

- **Enable HandyViewer**

Enable remote users to use a PDA or a mobile phone to access NV DVR server and select the video size and quality. (See also [Chapter 8.5 and 8.6](#))

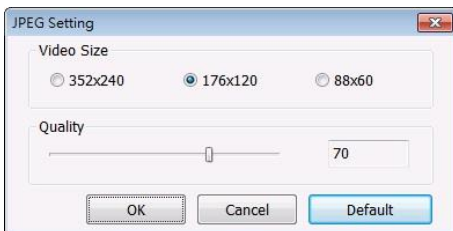

- **Network Bandwidth Limit**

- **By Channel:** Set the network bandwidth by each channel.
- **All:** Set the total network bandwidth consumption limit.

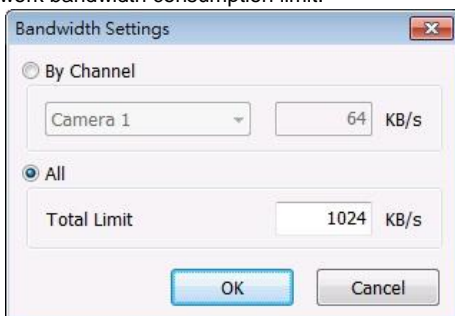

5.5 Schedule Setting

Schedule to record, backup, enable network, reboot and disable alarm of all the cameras either weekly or one time. The number from 00 to 23 represent the time in 24-hour clock. The left most column display the days in a week.

The screenshot shows the 'Schedule Setting' window. At the top, there is a calendar for May and June 2010. The date 26th of May is selected. To the right of the calendar is a dropdown menu labeled 'Record'. Below the calendar, there are two radio buttons: '@ WEEKLY' (selected) and 'ONE TIME'. At the bottom of the window, there are five buttons: 'Save', 'Clear', 'All', 'OK', and 'Cancel'.

	00	01	02	03	04	05	06	07	08	09	10	11	12	13	14	15	16	17	18	19	20	21	22	23
05/23 Sun																								
05/24 Mon																								
05/25 Tue																								
05/26 Wed																								
05/27 Thu																								
05/28 Fri																								
05/29 Sat																								

To Set the Schedule Setting:

1. Select the date in the calendar. Use ◀ and ▶ buttons to shift the calendar to the left or right.
2. Select the condition you want to schedule in the drop down list.

- Record

Activate all the cameras to start video recording at the set time based on the Recording setting (see also [Chapter 5.3](#)).

- **Backup**

To assign backup path, click .

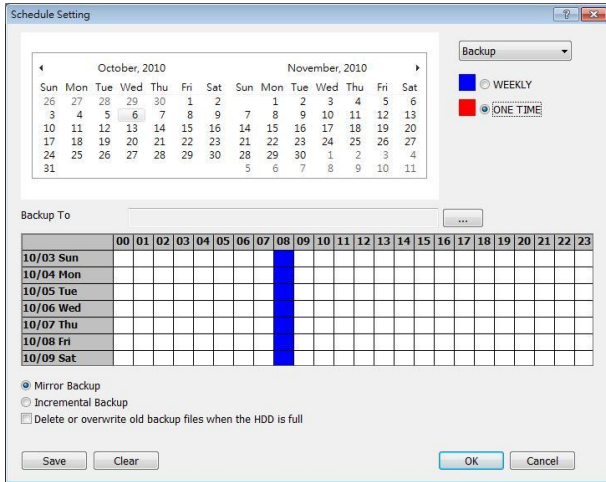

- ✓ **Mirror Backup:** Save a copy of all the data at the set time and specified backup path.
- ✓ **Incremental Backup:** Only backup the data that are not yet included in the archive from last time.
- ✓ **Delete or overwrite old backup file when the HDD is full:** The DVR system will automatically erase the old backup data when the hard disk is full.



Make sure the backup folder and storage folder are not on the same drive.

- **Enable Network**

Activate NV DVR remote system to access at the set time. After the appointed time, the Network function will be disabled. If the Network function is already enabled, the Network function will not be disabled when the appointed time has ended.

- **Reboot**

Restart the PC at the appointed time.



Make sure the Windows operating system is set **NOT** to require you to login user name and password. This way the system will be able to run NV DVR program.

- **Disable Alarm**

Deactivate the alarm at the set time temporarily.

- **Turn on Relay #**

Active the Relay at the set time. If there are no Relays are connected, Turn on Relay # function will not display in drag down list. The Relay number will depend on how many Relays are connected.

3. Specify to either schedule it weekly or one time. Click to make a selection.
4. Click on the blocks to set the schedule (see also [Chapter 5.5.1](#)). Or click **All** to select all. To store the setting, click **Save**. To remove the settings, click **Clear**.
5. To end Schedule Setting, click **OK** to exit and accept the setting and **Cancel** to exit without saving the setting.

5.5.1 To set schedule at a specific portion of time in that hour:

1. **Right click** the colored blocks.
2. In the Select time dialog box, click to enable or disable the portion you want to set.
3. Click **OK** to accept the setting and **Cancel** to exit without saving the setting.

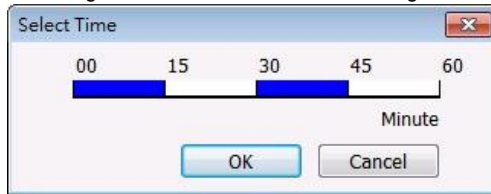

5.6 Backup Setting

In the Backup Setting dialog box, the number from 00 to 23 represent the time in 24-hour clock. The numbers from 01 to 16 represent the camera number. When you back up the file, you may find Qplayer application included in the backup folder (see also [Chapter 6](#)).

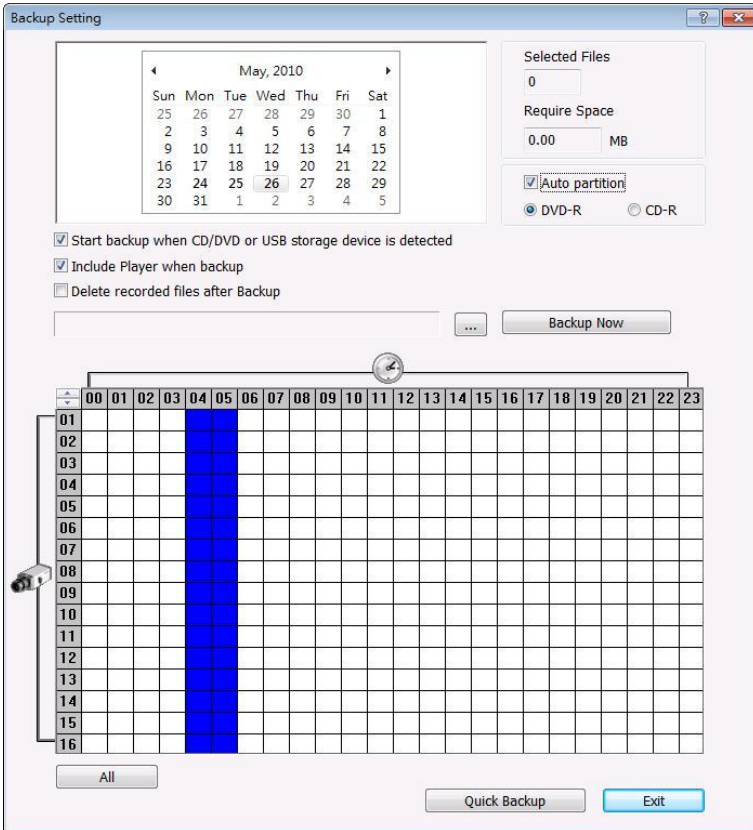

To Backup file:

1. Select the date of the recorded file in the calendar you want to backup. Use ◀ and ▶ buttons to shift the calendar to the left or right.
2. In the table below, click on the blue block to select the recorded file or click camera (01~16) or time (00~23) to select the whole row or column. The blue block turns red when it is selected. The block that appears in white doesn't have data. If you want to set the specific time, right-click on the selected block. Then, set the time to start and end.



User can select different date to backup, but it can't over 3 different date.

3. Check the information beside the calendar.
 - ✓ **Selected Files:** Show the number of files selected.
 - ✓ **Require Space:** Show the total size of the selected file
4. Enable **Auto partition** and select to divide the file size into DVD-R or CD-R. NV DVR automatically backup and divide the file sizes to facilitate burning into DVD or CD disc.
5. Enable **Start backup when CD/DVD or USB storage device is detected** that the Backup setting

windows will display on screen automatically when the DVR system detects CD/DVD-ROM disk or USB storage device. Right after user select the period of backup file, click , and the DVR system will start to backup without confirmation.

6. Enable **Include player when backup** that will included a **Qplayer** program for playback backup file in backup folder when backup. Only administrator user has the authority to enable or disable this function.
7. If you do **NOT** want to keep the recorded file in the storage folder, enable **Delete files after Backup** check box.
8. Click to set the path on where to store the backup file.
9. Click to start archiving the selected file.
10. In the Processing... dialog box, to stop archiving press **Abort**. When done, in the Backup Path list, shows the archived item. To burn the file in CD, you need to have NERO 6 or NERO 7 installed in your PC then select the item in the list and click **Burn**. Click **Exit** to end this procedure and burn it later.

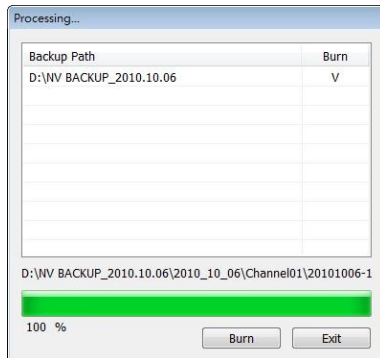
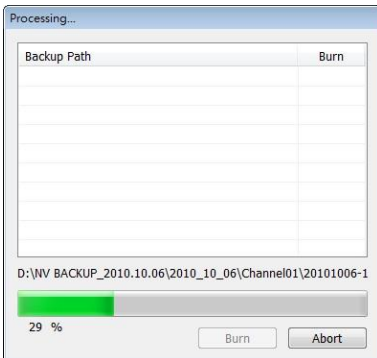

11. In CD/DVD Backup, enable/disable Delete file after burning check box to remove the archived file after burning. Click **Burn** to start and **Exit** to cancel this process.

5.6.1 Setup Quick Backup

1. Click **Quick Backup**
2. In Quick Backup Setting window, mark **Enable**
3. And then, select the channels that want to backup and click to select the save path.
4. **Backup Last:** Set the backup time period. For example: time before 60 minutes means backup the recorded file from now backward 60 minutes. Present time is 13:00, the system will backup start from 12:00 to 13:00 when press quick backup button

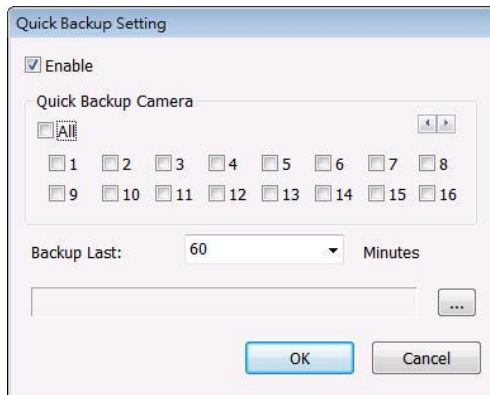

5.7 Sensor Setting

The I/O device must be installed to use this function. The NV DVR system also support external I/O box and user can install external sensors. For external sensor setting, please referring to the sensor vendor user's manual.

To Set the Sensor Setting:

1. Click the drop-down list and select the sensor ID number.
2. Enter sensor name.
3. The system automatically detects the card and input number. In the Content section, enter sensor description.
4. In the test section, click **Test** to check the sensor status. Red is high and Green is low.
5. Click **OK** to exit and accept the setting and **Cancel** to exit without saving the setting.
6. Click **External IO** to configure external I/O device if it is available (see also [5.8.1](#)). When external I/O is set and it will be available in drag down list for selecting.

The image shows a 'Sensor Setting' dialog box with the following components:

- Title Bar:** 'Sensor Setting' with a help icon and a close button.
- Drop-down Menu:** A list box for selecting a sensor ID number.
- Name:** A text input field.
- External IO:** A button to configure external I/O devices.
- Content:** A section containing three input fields: 'Card No.', 'Input No.', and 'Description'.
- Test:** A section containing a green box labeled 'Low' and a 'Stop' button.
- Bottom Buttons:** A keyboard icon, 'OK', and 'Cancel' buttons.

5.8 Relay Setting

The I/O device must be installed to use this function.

To set the Relay Setting:

1. Click the drop-down list and select the relay ID number.
2. Enter relay name.
3. Mark **Enable** to enable the selected relay. If user wants to apply the setting to all relays, click **Apply to all** button after complete the setting of the relay.
4. The system automatically detects the card and input number. User can enter a short description for this relay in **Description** frame.
5. To set all relay devices for same setup setting, mark **Enable** and click **Apply all**.
6. Mark **Enable Pulse trigger** the relay will be triggered depends setting of **Interval Time** and **Retrieve Time**. **Interval Time** is a time gap for the relay will be triggered, for example: the relay will be triggered every 3 seconds if interval time is set to 3 seconds. **Retrieve Time** is the time that relay is staying in trigger status, for example: when relay has been triggered and it will continuous in trigger status for 2 second if retrieve time is set to 2 seconds.
7. In the test section, click **Test** to trigger relay. Red is high and Green is low.
8. Click **OK** to exit and accept the setting and **Cancel** to exit without saving the setting.
9. Click **External IO** to configure external I/O device if it is available (see also [5.8.1](#)). When external I/O is set and it will be available in drag down list for selecting.

Relay Setting

[?] [X]

[Dropdown]

Name [Text Field]

Enable [Apply to all] [External IO]

Content

Card No. [Text Field]

Input No. [Text Field]

Description [Text Field]

Test

[Text Field] [Test]

Pulse trigger

Enable Pulse trigger

Interval Time [Text Field] Sec.

Retrieve Time [Text Field] Sec.

[Icon] [OK] [Cancel]

5.8.1 To Setup External I/O Box

The DVR system can connect the external I/O box for extra of I/O devices installation.

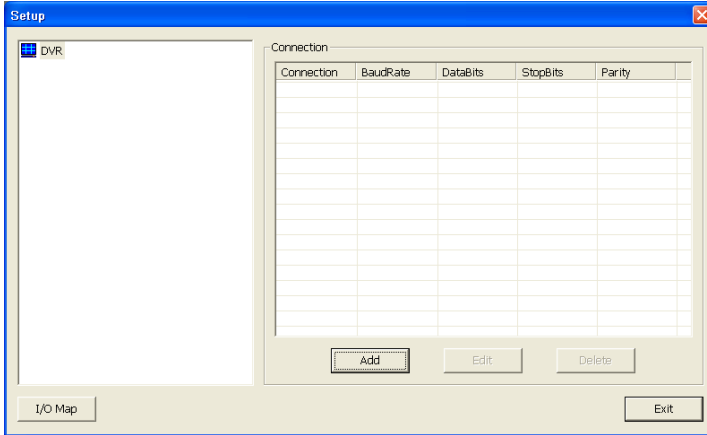

1. Click **Add**.
2. Mark **Enable** box to enable this external I/O box.
3. Select the Brand of external I/O box from drag down list.
4. Select the connection type – **Ethernet** or **RS-232**.
5. For Ethernet connection, enter **IP Address** of I/O device or click **Search IO Device** button to search any I/O device on LAN network.
6. For RS-232 connection, different brand of external I/O box may have different port parameters. Please refer to the external I/O box's user manual for port setting information. Using the default value if user uses External I/O box of AVerMedia.
7. Click **OK** to save the setting.
8. To add more than one external I/O box, click **Add** and follow the above steps.

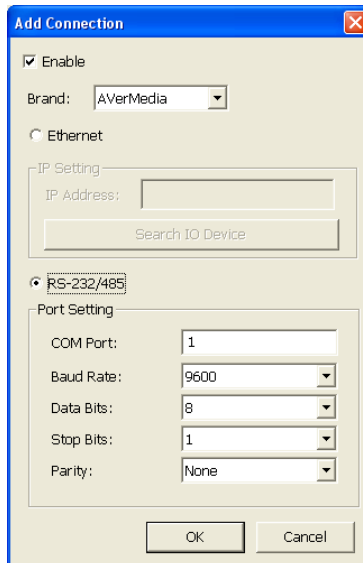

9. In External I/O box setup dialog, user will see all added External I/O. Click added External I/O

- box and click **Add** to scan the connected relays and sensors.
- In **Add Module** windows, click **Scan** to scan the connected relays and sensors on the External I/O box.
 - All connected relays and sensors will be listed. User can click radio button to control relays' status. And then, click **OK** to save the setting and click **Cancel** to exit and without saving.

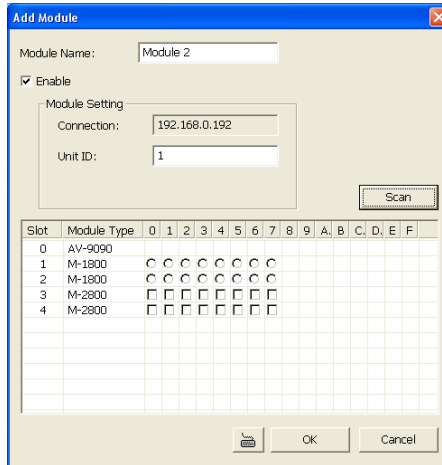

- All connected External I/O box and their modules will be listed as tree topology in External I/O Setup windows.

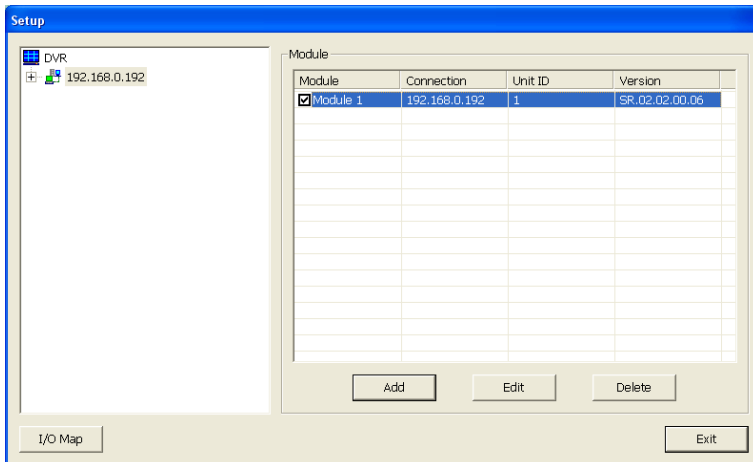

- To view the all I/O devices information, click **I/O Map**.

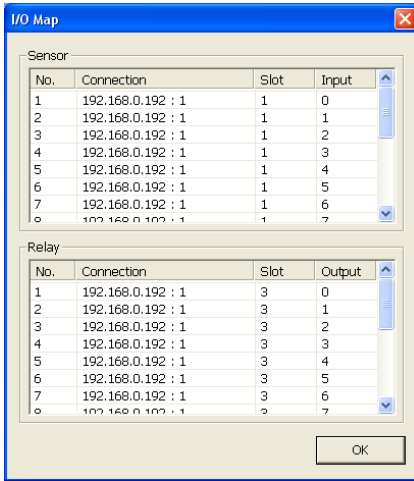

5.9 Alarm Setting

In the Alarm Setting dialog box, click **Add** to insert and set new alarm setting, click **Delete** to remove the selected alarm setting, click **OK** to exit and save the setting, **Cancel** to exit without saving, and **Default** to revert back to original factory setting.

The screenshot shows the 'Alarm Setting' dialog box. It contains the following elements:

- (1)** Points to the 'No.' field, which contains '1'.
- (2)** Points to the 'Enable Time' grid, which shows a 24-hour clock from 00 to 23. The grid is currently set to 'Enable'.
- (3)** Points to the 'Conditions' section, which includes options for 'Trigger if any' (selected) and 'Trigger if all', and a list of conditions like 'Motion Detected', 'Video Loss', etc.
- (4)** Points to the 'Sensor' section, which includes 'High' and 'Low' sensor settings.
- (5)** Points to the 'Alarm Reset' section, which includes 'High' and 'Low' reset settings.
- (6)** Points to the 'Priority' dropdown menu, which is set to '3'.
- (7)** Points to the 'OK' button.
- (8)** Points to the 'Alarm Setting List' on the right side of the dialog, which shows a table with columns for 'No.', 'Name', and 'Description'.

To set the Alarm Setting:

1. Click **Add** to insert and set a new alarm setting. Click the items in the **(8) Alarm Setting List**, if you want to modify the alarm setting.
2. In **(1) Alarm Setting number/Name/Description**, display the selected alarm setting number in the list below. Enter alarm name and description.
3. In **(2) Enable Time**, the number from 00 to 23 represent the time in 24-hour clock. Click **Schedule** to select the time and date that you want to activate or deactivate the alarm function. Select **Enable** or **Disable** and click the block that user want to activate or deactivate the alarm function.

The screenshot shows the 'Alarm Schedule' dialog box. It contains the following elements:

- Name:** Alarm4
- Enable/Disable:** The 'Enable' checkbox is selected.
- Schedule Grid:** A grid showing the days of the week (Sun to Sat) and the 24-hour clock (00 to 23). The grid is currently set to 'Enable'.
- Buttons:** 'OK' and 'Cancel' buttons.

4. In **(3) Conditions**, you can set **Trigger if any** to activate if it falls to one of the conditions or

“Trigger if all” to activate if it falls to all conditions.

- **Motion Detected:** select and click on the camera number (01 to 16) to set the condition for the system to alarm. **Right-click** on the camera number to setup the system to send out the alarm when motion has been detected last the time that user has entered in **Continuous trigger duration**.

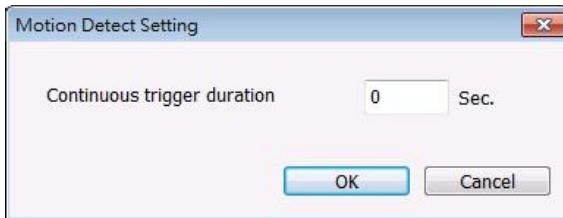

- In **Video Loss**, click the camera number (01 to 16) to set the alarm condition when video is lost. **Right-click** on the camera number (01 to 16) to setup the system to send out the alarm when video has been lost to last the time that user has entered in **Continuous trigger duration**.

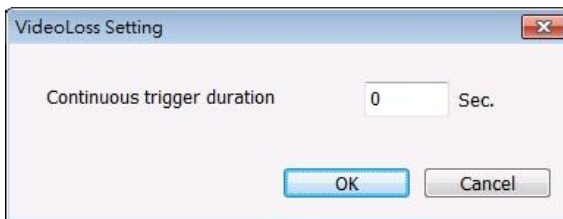

- In **Missing and Suspicious Object Detected**, click the camera number (01 to 16) and select the certain object on the screen (right click on camera number for detailed setting), and when the certain object is missing or doubtful, the system will alarm. (see also [Chapter 5.9.12](#))
 - In **Scene Change**, when the camera has been moved, the system will alarm, too.
 - In **Audio Detect**, click the camera number (01 to 16) to set the alarm condition when detect the abnormal audio.
5. In **(4) Sensor**, select and click on the sensor number (use ◀ and ▶ to select the sensor) to set the condition for the system to alarm. If the sensor normal status is high, set the sensor condition to low (see [chapter 5.7 step #4](#)).

Click **IP Camera Sensor** to configure sensor status of IP camera. Click **High/Low** to set sensor status to high or low.

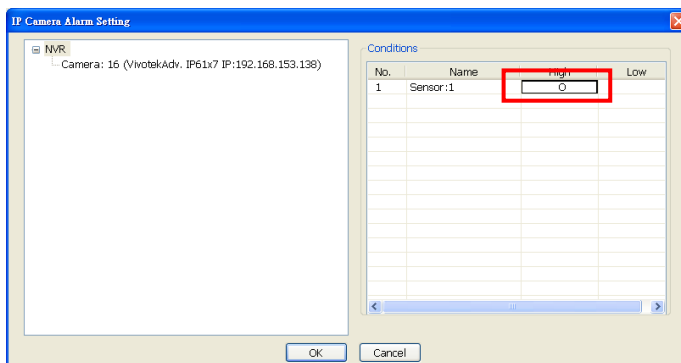

- **Continue trigger duration:** Set a time period for system to send out the alarm when sensor

has been trigger and stay in the same status for a period.

- Enable/disable the **Abnormal Event** check box, to set the condition of the event for system to alarm.

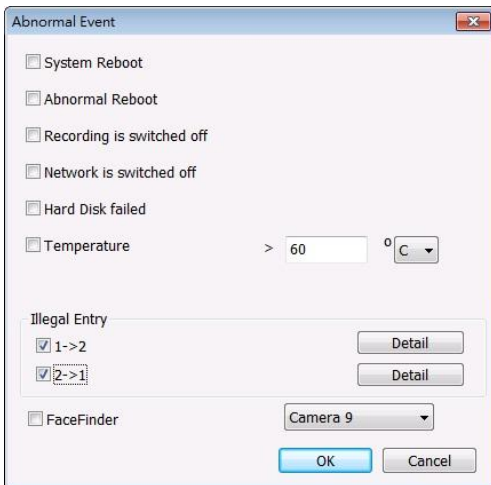

- **System Reboot:** when the NV DVR system reboot without abnormal condition, the system will send out the alarm message.
- **Abnormal Reboot:** when the NV DVR system reboot in irregular condition, the system will send out the alarm message.
- **Recording is switched off:** when the recording has been stopped, the system will send out the alarm message.
- **Network is switched off:** when the network connection of DVR system is lost, the system will send out the alarm message.
- **Hard Disk failed:** when the hard disk doesn't work normally, the system will send out the alarm message.
- **Temperature:** set a temperature limited of system for system to alarm. When DVR system temperature is over the temperature limited, the system will send out the alarm. The system supports °C and °F temperature mode.



Temperature setting doesn't support on NV3000T/5000 card.

- **Illegal Entry:** any objects move between selected regions which user has set up in **Object Counting** section (see [Chapter 5.2.1](#)), the system will send out the alarm. Select the entry (object moves from region 1 to 2 or from region 2 to 1) and click the **Detail** to select the camera and the times for system alarm.
 - ✓ **Trigger if once:** Send out the alarm when the selected camera match the illegal entry has selected.
 - ✓ **Trigger if the amount exceeds:** Send out the alarm when the selected camera and illegal entry times match the illegal entry has selected.





Only the camera has been setup in **Object Counting** will be available for selecting in **Illegal Entry**.

- Enable/disable the **POS Keyword** check box, to scan the data from the POS if it matches the keyword (see also [Chapter 5.9.10](#)).
- Enable/disable the **Alarm Message** check box, to active with external alarm message by your own program. For the detail configuration, please contact the local reseller.
- Enable/disable the **Alarm Button** check box, to active manual alarm function (see also [Chapter 4.3#\(17\)](#)). To define alarm message of manually alarm trigger. Click alarm button and select the alarm button # and fill in the description of alarm button.

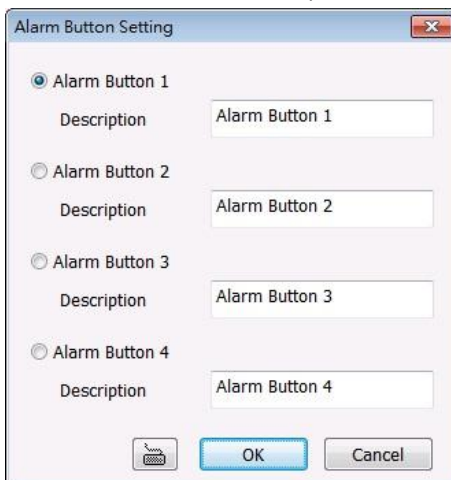

6. In **(5) Alarm Reset**, click the camera number (use ◀ and ▶ to select the alarm) to set the reset condition of alarm. Once alarm is reset, all alarm action will stop at the moment. If the sensor normal status is high, set the sensor condition to low.

To set sensor status of IP camera, click **IP Camera Sensor**. In IP Camera Alarm Setting windows, click **High/Low** to set sensor status.

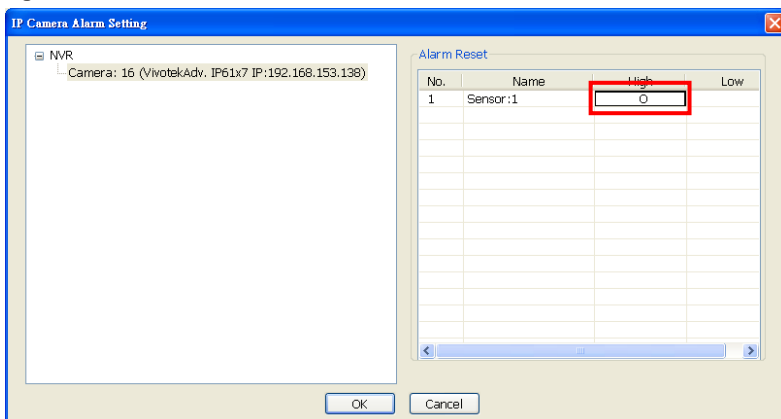

- **Alarm Reset Time:** Set a time for the alarm auto reset. When an alarm happen such as motion detected and video loss, the alarm will reset at the alarm reset time.

7. In **(6) Priority**, user can set the priority of this alarm. The priority of the alarm can be seen in CMS site (Central Management System).
8. In **(7) Action**, you may now set the alarm action for the system to perform when the alarm condition is activated.

- **Launch E-Map**

Display mini Emap screen.

- **TV Out**

Switch to only display the video on TV from where the alarm is activated or selected camera.

- a. Select the camera from drop down list to specify which camera video to be displayed on TV when the alarm is triggered.
 - ⊙ **Alarm Camera:** when a channel has an alarm occurred, and then, the channel video that has an alarm occurred will be displayed on TV.
 - ⊙ **Camera #(1~32):** select the camera channel video that wants to be displayed on TV when an alarm is activated.
- b. **Retrieve time:** set the waiting duration before system switching back to original display mode on TV automatically. If the retrieve time is un-mark, the alarm video will keep displaying until user switch back to normal display mode manually. The retrieve time range is 3~ 600 seconds.

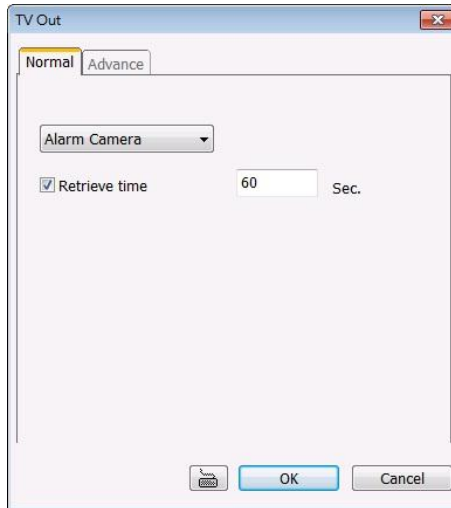

- **Enlarge Camera View**

Switch to only display video in Preview/Advanced mode from where the alarm is activated.

- a. Select the camera from drop down list to specify which camera video to be enlarged on screen when the alarm is triggered.
 - ⊙ **Alarm Camera:** when a channel has an alarm occurred, and then, the channel video that has an alarm occurred will be enlarged on screen.
 - ⊙ **Camera # (1~32):** the selected channel video that will be enlarged on screen when an alarm is activated.
- b. Select the display mode – **1 Channel** or **Full Screen**.
- c. **Retrieve time:** set the waiting duration before system switching back to original Preview mode. If the retrieve time is un-mark, the alarm video will keep enlarging until user switch back to Preview mode manually. The retrieve time range is 3~ 600 seconds.

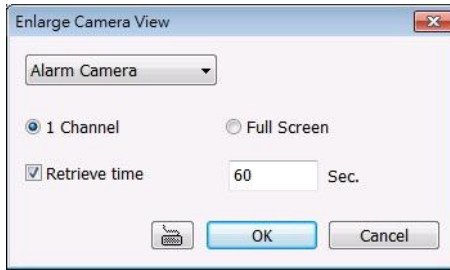

- **Relay Output**
Set to enable/disable the relay operation when the alarm is activated and to extend additional time in second before it stops the relay operation.
- **IP Camera Relay**
Set to enable/disable the relay operation when the alarm is activated.

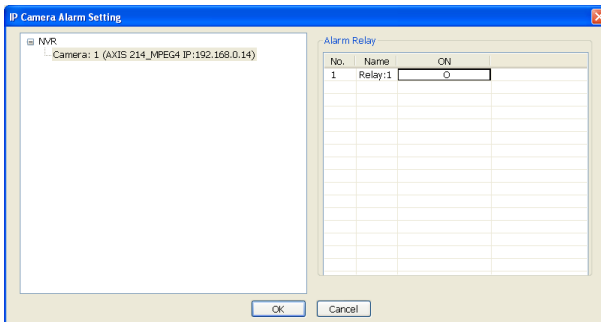

- **Play Warning Sound**
Play alarm sound. To setup click **Detail** (see also [Chapter 5.9.2](#)).
- **Make Phone Calls**
Dial and contact the number in the list. To setup click **Detail** (see also [Chapter 5.9.3](#)). To use this feature, the PC must have a voice modem connected to it. The supported audio system is only 8KHz and 16Bit mono.
- **Send E-mail**
Send an electronic text message. To setup click **Detail** (see also [Chapter 5.9.4](#)).
- **File Transmission via FTP**
Upload file to remote computer thru FTP (File Transfer Protocol). To setup click **Detail** (see also [Chapter 5.9.5](#)).
- **Start Recording**
Record the video from the selected camera. To setup click **Detail** (see also [Chapter 5.9.6](#)).
- **SMS (Short Message Service)/MMS (Multimedia Messaging System)**
SMS transmits only text messages to mobile phone. MMS transmits text messages and images over wireless networks using the wireless application protocol (WAP). Make sure your mobile phone support this feature and your PC is connected to GSM/GPRS modem. To setup click **Detail** (see also [Chapter 5.9.7](#)).
- **PTZ preset point**
Position the PTZ camera based on the preset point setting. To setup click **Detail** (see also [Chapter 5.9.8](#)).
- **Alarm SOP (Standard Operation Procedure)**

List the instructions to inform the person of what to do when the alarm is activated. To setup click **Detail** (see also [Chapter 5.9.9](#)).

- **Send to CMS (Central Management System)**

Enable/disable the selected camera to send video to CMS when the alarm is activated (see also [Chapter 5.9.10](#))

- **Launch Program**

To call up the external program that is provided by 3rd party. Click **Detail** and click to locate the program path. Enable **Multiple instance** check box to allow the program can be executed multiple times at the same time.

- **Snapshot**

Take a snapshot when the alarm is activated.

a. **Select Camera:** specify which channel video to be snapshot when the alarm is occurred.

- **Alarm Camera:** when a channel has an alarm occurred, and then, the DVR system will snapshot the channel video.

- **Camera # (1~32):** the selected channel would be snapshot when an alarm is occurred.

b. **Video Size:** select the size of snapshot picture.

c. **Number of picture:** the number of picture that is going to be taken.

d. **Snapshot Interval:** a time gap for next snapshot

e. **Save Path:** a storage path for saving snapshot pictures.

f. **Delete image after:** set a storage limit of snapshot image. When the snapshot image is over the limit, and then, the system will start recycle the snapshot image.

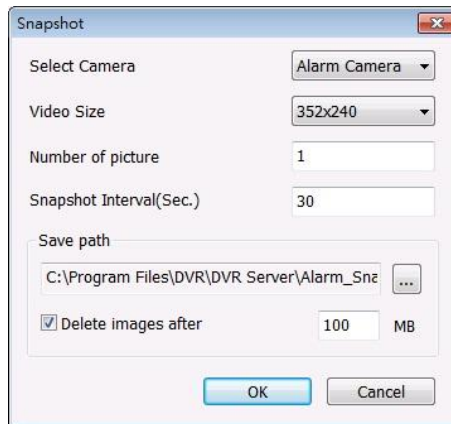

5.9.1 To Setup Alarm Relay

1. Beside the Relay Output check box, click **Detail**.
2. In the Alarm Relay dialog box, select from the available relay list and in the ON column, set to enable/disable the relay operation when the alarm is activated.
In the Retrieve time check box, you may enable/disable to extend the relay operation time and set the duration in second.
3. Click **OK** to exit and accept the setting and **Cancel** to exit without saving the setting.

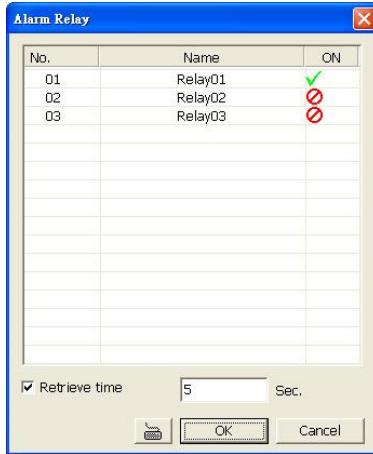

5.9.2 To Setup the Alarm Sound Setting

1. Beside the Play Warning Sound check box, click **Detail**.
2. In the Alarm Sound Setting dialog box, click **...** to select other wav file from other source or folder, **Play** to listen, **Record** to make a new copy of a sound.
3. Select the **Play Mode**.
 - ✓ **Interrupt**: when receive the new alarm warning, immediately play new warning sound.
 - ✓ **Play by sequence**: when receive the new alarm warning, play after the on playing alarm warning.
4. If you click **Record**, you will be prompted if you want to replace the file. Click **OK** to continue and **Cancel** to discontinue.
5. When the Sound Recorder appears, use the record control panel to record, stop, play, rewind and forward. If you want to keep the existing file, click **File > Save As...**, enter filename and click **Save**. Make sure you have microphone connected to your PC.
6. Click **OK** to exit and accept the setting and **Cancel** to exit without saving the setting.

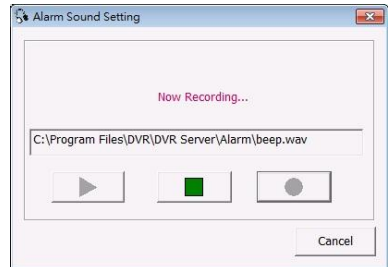
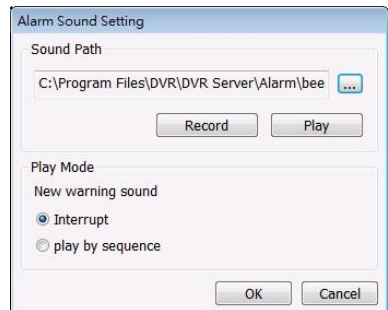

5.9.3 To Setup Call Out List

1. Beside the Make Phone Calls check box, click **Detail**.
2. In the Call Out List, click **Add** to insert a new contact number, **Modify** to edit the selected item, **Remove** to delete the selected item, **Test** to check if it is working.
3. In the Call Out Setting, enter the phone number and description. Click **...** to select existing sound recorded messenger and **Record** to make a new voice message.
4. When the Sound Recorder appears, use the record control panel to record, stop, play, rewind and forward. If you want to save the file, click **File > Save As...**, enter filename and click **Save**. Make sure you have microphone connected to your PC. The supported audio system is only 8KHz and 16Bit mono.
5. Click **OK** to exit and accept the setting and **Cancel** to exit without saving the setting.

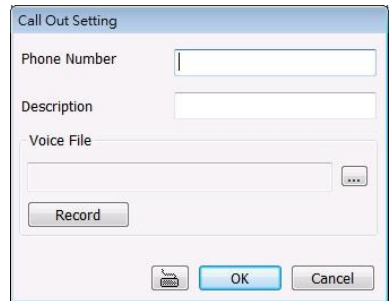
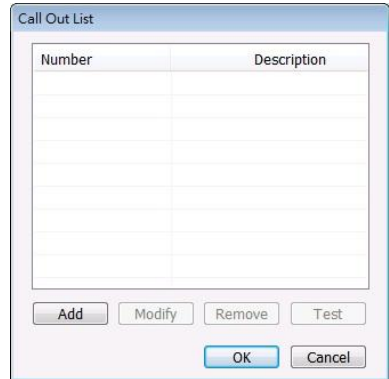

5.9.4 To Setup Send E-mail Setting

Beside the Send Email check box, click **Detail**. In the E-mail Setting dialog box, click **OK** to exit and save the setting and **Cancel** to exit without saving the setting.



Gmail is supported now.

The screenshot shows the 'E-Mail Setting' dialog box with four numbered callouts: (1) points to the 'Mail Server' section, (2) points to the 'Mail' section, (3) points to the 'Email Notice Setting' section, and (4) points to the 'Modem Dial up Setting' section.

(1) Mail Server

Enter the SMTP Server and port. If your e-mail system requires user identification, enable **Authentication** check box and enter User ID and Password.

(2) Mail

To check if it is working, click **Test Account** button.

- ✓ **From:** Enter the sender e-mail address.
- ✓ **To and CC:** Enter the recipient email address and separate it with comma or a semicolon (;).
- ✓ **Subject:** Enter the message title.
- ✓ **Message:** Type the message.

(3) Email Notice Setting

- ✓ **Notice Interval:** Set the period of time before it sends another e-mail notice.
- ✓ **Embedded image :** Select the sending image's size and set the number of frames.
- ✓ **Attach image when sensor is triggered:** When the sensor is triggered, the system will capture the image and send the image to the certain e-mail address with the alarm message.



If the alarm is not triggered by sensor, the system will depends on the setting of motion detected, video loss, audio detect, and sensor in alarm setting to send the alarm image and alarm message.

(4) Modem Dial up Setting

If you are using dial up modem, enable **Auto Dial up** check box and select the modem name. You may also set the time to disconnect automatically, just enable the **Auto Disconnect after** check box and set time.

5.9.5 To Setup FTP Setting

1. Beside the File Transmission via FTP check box, click **Detail**.
2. In the FTP Setting dialog box, enter the FTP IP, port, user ID and password.
3. In **Number of Pic** text box, enter the number of sequence images that want to send when file is transmitting. The maximum number of picture can be transmitted are 16.
4. If user wants to send the recorded image before alarm occurs, enter the time that before alarm occurs in **Before alarm(sec.)**.
5. **Upload image:** Select the camera that the images will be captured and send when the any alarm is triggered. If user select the **Alarm Camera**, then only when motion trigger, video loss, missing or suspicious object/scene change will send out the alarm image.
6. Click **OK** to exit and save the setting and **Cancel** to exit without saving the setting.

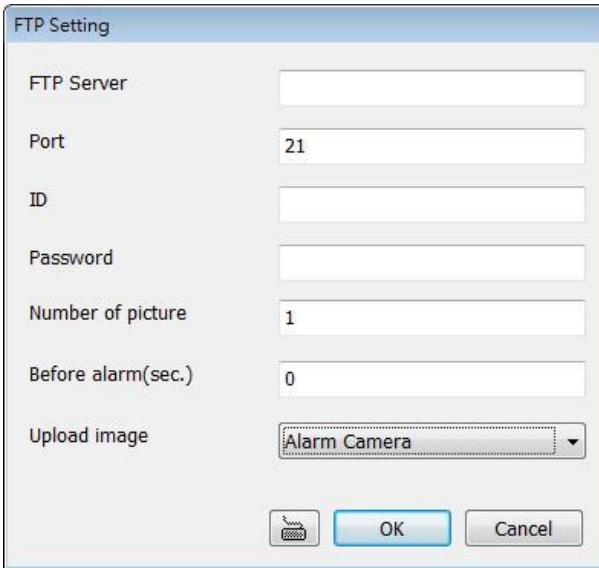

FTP Setting

FTP Server

Port

ID

Password

Number of picture

Before alarm(sec.)

Upload image

5.9.6 To Setup Alarm Recording Setting

1. Beside the Start Recording check box, click **Detail**.
2. In the Alarm Recording Setting dialog box, select the camera to enable/disable video recording. Enable **All** to select all cameras.
3. In the Frame Rate selection, select **As Setting** to record the number of frames based on the Recording Setting or **Max** to record the maximum of frames based on the available speed (maximum is 32 pictures)
4. In the **Start Recording prior** text box, mark and set the number in second for the program to pre-recording before the alarm happen. The time range is 1~10 seconds.



- When camera is Analog or IP camera and recording resolution less or equal to D1, the DVR system only record in key frame for pre-recording.
- When camera is Mega-pixel IP camera and the recording resolution is greater than D1, the DVR system won't do any pre-recording.

5. In the **Stop Recording after** text box, mark and set the number in second for the program to continue recording after the alarm has ended. The time range is 1~600 seconds. If user doesn't mark and set the time, the alarm recording will continue recording until alarm is reset.
6. Click **OK** to accept the new settings and **Cancel** to exit without saving.



5.9.7 To Setup SMS/MMS Setting

To use this feature, GSM/GPRS modem is required. Connect the GSM/GPRS modem to the serial COMM port of PC. Beside the SMS/MMS check box, click **Detail**.



MMS module is developed by ActiveXperts Software B.V.

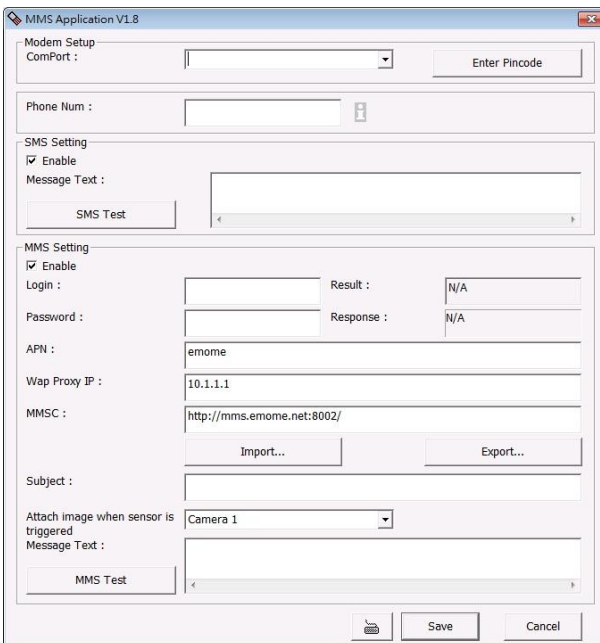

1. Select the COM port number from **ComPort** drop down list which the GSM/GPRS modem is connected. If your ISP requires the PIN code authorization, click **Enter Pincode** to enter the PIN code which your ISP provided.
2. In **Phone Num** text box, enter the contact number.
3. You may now set to send thru SMS or MMS. If you enable **SMS setting**, just enter the message in the text box. If you enable **MMS**, enter the APN name, WAP IP, MMS address and the message. If you are not sure, please contact your mobile service provider.
4. **Attach image when sensor is triggered**: select the camera that the images will be capture and send when the sensor is triggered.
5. Click **OK** to accept the new settings and **Cancel** to exit without saving.



Make sure your ISP provider and cell phone provider both support JPG file format transmitting.

5.9.8 To Setup PTZ Preset Point

Beside the PTZ preset point check box, click **Detail**. In the Trigger PTZ Preset Setting dialog box, select the PTZ camera number then select the Enable check box. Select the position of the PTZ camera when the alarm is activated and ended. For the PTZ camera ended point, user also can select one preset position or **Auto Path** between preset position group.

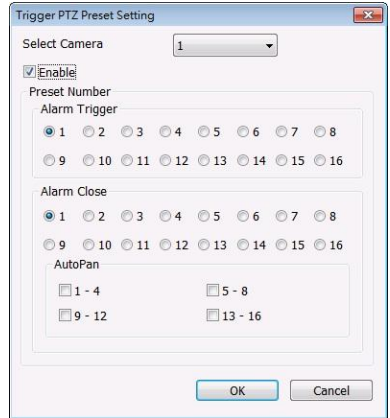

5.9.9 To Setup Alarm SOP

Beside the Alarm SOP check box, click **Detail**. In the step text boxes, type the standard protocol when the alarm is activated. When the alarm is activated, the Standard Operation Procedure dialog box will appear. Just click **Next** to see the next instruction, **Back** to see the previous instruction, **Finish** to end and **Abort** to terminate.

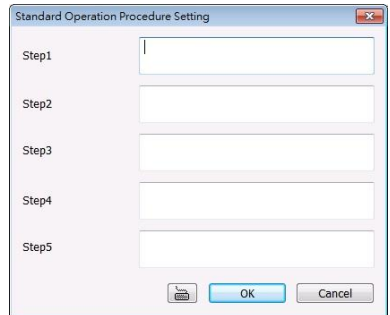

5.9.10 To Setup CMS Setting

Beside the Send to CMS check box, click **Detail**. Click **OK** to accept the new settings and **Cancel** to exit without saving.

- **CMS**: Select the camera to enable/disable sending the video to CMS.
- **Matrix**: Select the camera to enable/disable sending the alarm event video to CMS. The CMS site need to setup a matrix channel to



receive the alarm event from DVR server site(please refer to CMS manual for detail)

5.9.11 To Setup POS Keyword Setting

1. Beside the Send to POS Keyword check box, click **Detail**.
2. In the POS Keyword Setting, select the camera to enable/disable scanning the keyword. Enable **All** to select all cameras.
3. Enter the text below keyword text box. Click **Add** to include the keyword in the list. To remove, select the word in the list and click **Delete**. You may only add 8 keywords. User can define the color for each keyword. To set the color, click the color panel after next to POS keyword column and a color selection window will pop up. Select the color that user wants and click **OK**.
4. Click **OK** to accept the new settings and **Cancel** to exit without saving.

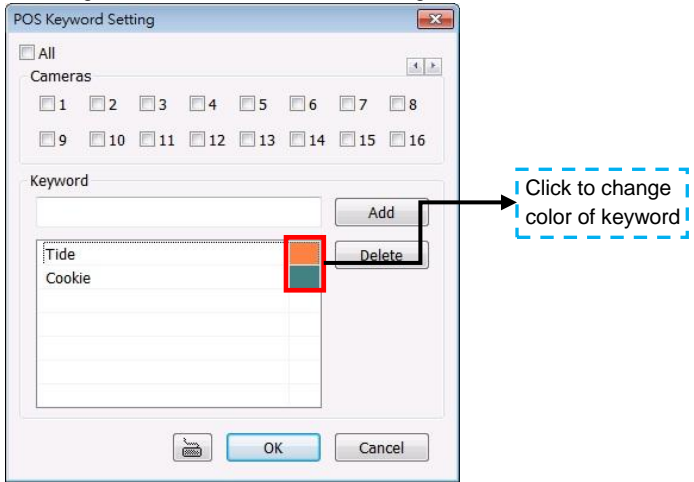

5.9.12 Missing, Suspicious Object, and Scene Change Detected

① Missing Object

Select the certain object on the screen for the system to detect; when the object is disappear or move and the system will alarm. Click **OK** to exit and save the configuration. To exam the setup condition, click **Start Test**.

1. Select the camera number (0-16) and press RIGHT button on the mouse to call up the setup windows.
2. Click **Save** to capture the image for comparing reference first. To view the captured image, enable the **Show Reference Image** check box. The captured image will display on screen. The reference image is sharing with the Suspicious Object and Scene Change function.
3. Mark the **Enable** check box to setup the condition.
4. Use the mouse to click and drag the frame on the screen. User can drag more than one frame.
5. **Sensitivity:** Set the system detects sensitivity.
6. **Delay Time:** Set the lasting time for system to detect the object.
7. To reset all object frames, click **Clean**. To clean an object frame, click right button of mouse and drag the object frame that user want to clean.

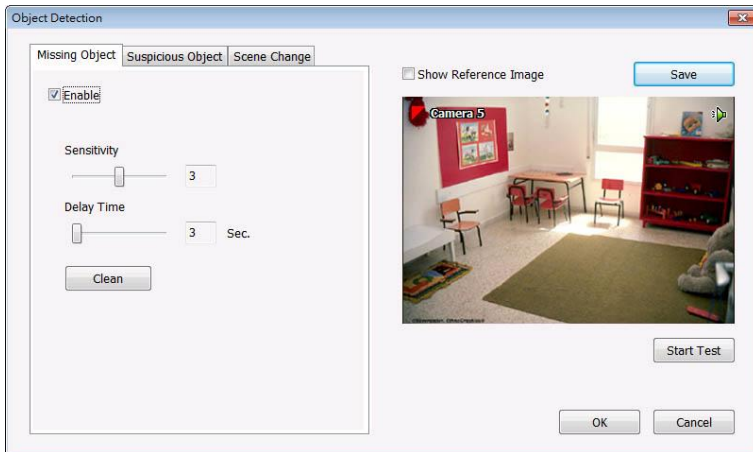

② Suspicious Object

Suspicious Object is including the object missing or the doubtful object appears on the screen. Click **OK** to save and exit the setup windows. To exam the setup condition, click **Start Test**.

1. Select the camera number (0-16) and press right button on the mouse to call up the setup windows. And then, click the **Suspicious Object** Tab.
2. Click **Save** to capture the image for comparing reference. To view the captured image, enable the **Show Reference Image** check box. The captured image will display on screen. The reference image is sharing with the Missing Object and Scene Change function.
3. Mark the **Enable** check box to setup the condition.
4. **Sensitive:** Set the system detects sensitivity.
5. **Delay Time:** Set the lasting time for system to detect the object.
6. Use the mouse to click and drag the frame on the screen.
 - **Maximum_Object:** the maximum detect size. The objects are out of the maximum detect area will be disregard. Use mouse to click and drag the frame on the screen.
 - **Minimum_Object:** the minimum detect area. When the objects are smaller than the minimum detect area, the system will disregard. Use mouse to click and drag the frame on the screen.
7. **Enable Mask**
Mark an area on the screen to disregards the motion in the marked area and to only monitor outside the marked area. Mark the **Enable Mask** check box, click and drag the mask frame

on the screen.

- To reset all object frames, click **Clean**. To clean an object frame, click right button of mouse and drag the object frame that user want to clean

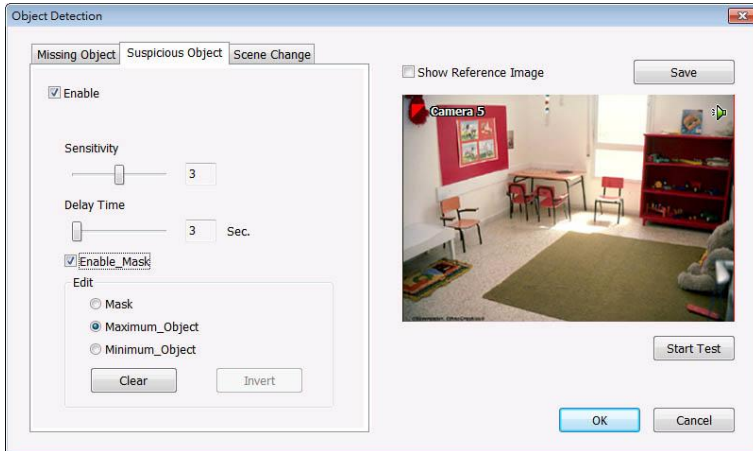

⊙ Scene Change

When the camera has been moved, the system will alarm.

- Select the camera number (0-16) and press right button on the mouse to call up the setup windows. And then, click the **Scene Change** Tab.
- Click **Save** to capture the image for comparing reference. To view the captured image, enable the **Show Reference Image** check box. The captured image will display on screen. The reference image is sharing with the Missing Object and Suspicious Object function.
- Mark the **Enable** check box to setup the condition.
- Sensitive**: Set the system detects sensitivity.
- Delay Time**: Set the lasting time for system to detect the movement.
- Change Rate**: Set the camera movement range which compare with the original position.
- Enable Mask**: Select an area on the screen to disregards the motion in the marked area and to only monitor outside the marked area. Mark the **Enable Mask** check box, click and drag the mask frame on the screen.
- To reset all object frames, click **Clean**. To clean an object frame, click right button of mouse and drag the object frame that user want to clean.

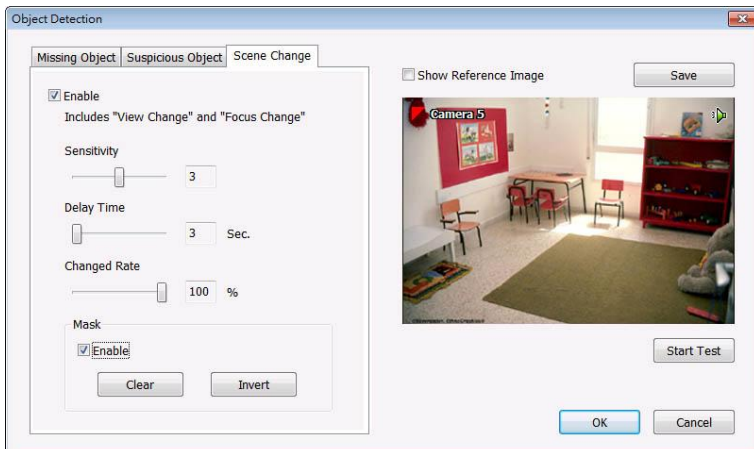

5.10 User Setting

Users with **Administrator** privileges can access **User Setting**. The maximum user accounts are 256. In the User Setting dialog box, click **Add** to insert a new user, **Delete** to remove the selected user, **Edit** to modify the user control right, **OK** to exit and accept the setting, and **Cancel** to exit without saving the setting.

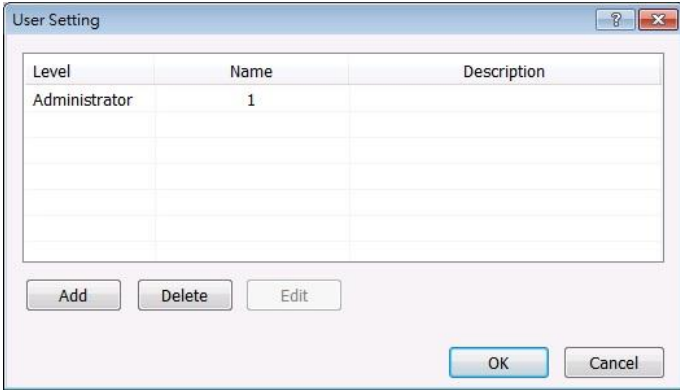

After clicking **Add** or **Edit**, you may customize the user control setting. **OK** to exit and accept the setting, and **Cancel** to exit without saving the setting

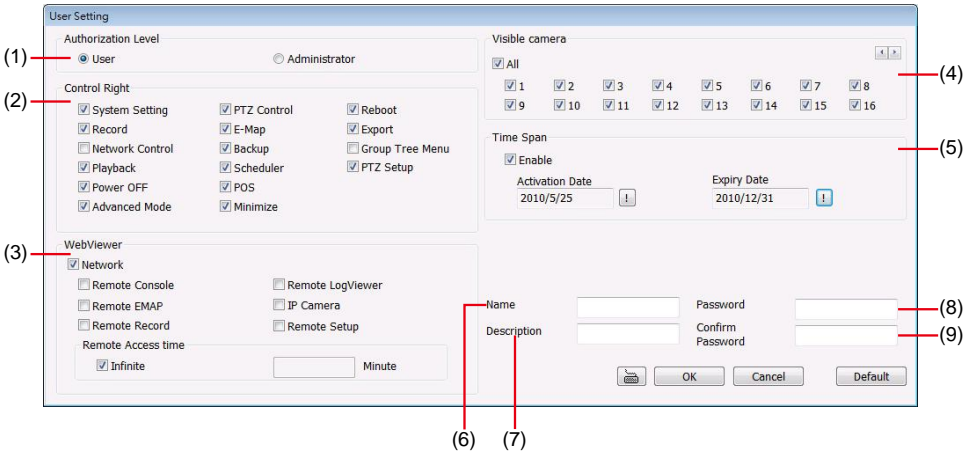

(1) Authorization level

Select the status of the user. Only Administrator-level can access User Setting, and reset the Alarm status when using the Remote Console.

(2) Control Right

Enable the items that would allow the user to access.

(3) Web Viewer

Enable/disable Web Viewer control right that allow the user to operate from a remote location using internet explorer.

- **Remote Console**
Allow the user to remote modify NV DVR system setting.
- **Remote LogViewer**
Allow the user to view the event log from remote site.
- **Remote EMAP**

- Allow the user to view the E-map of NV DVR from remote site.
- **Remote Record**
Allow the user to record video at remote site.
- **IP Camera**
Enable/disable user to add new IP camera when using the Web Viewer.
- **Remote Setup**
Allow the user to modify the DVR system setup from remote site.
- **Remote Access Time**
Enable **Infinite** check box to access NV DVR without time limit. If you want to set time limit, enter the number of minutes in **Minute** text box.

(4) Visible Camera

Select the camera number that would allow the user to access or view. To select all the cameras, enable the **ALL** check box.

(5) Time Span

Set the user account a specific time period that user only can use given account to login DVR program in that specific period. Mark **Enable** check box and select the **Activation Date** and **Expiry Date**.

(6) Name

Enter the user name.

(7) Description

Enter the user description.

(8) Password

Enter the user password.

(9) Confirm Password

Enter the same user password for confirmation.

Chapter 6 Playback Backup Video

You can playback the backup files using QPlayer applications. When you back up the recorded file, QPlayer applications are automatically included in the backup folder. Qplayer also can be installed when install Web Tool from installation CD-ROM.

With QPlayer, it is the same as in Playback mode and supports 6 different split screen types to view all the video at the same time. User even can select the different language of display UI. The only difference is that there are no Preview and Playback buttons.

To run the application, go to backup folder and double-click Q Player icon.

6.1 Familiarizing QPlayer Buttons

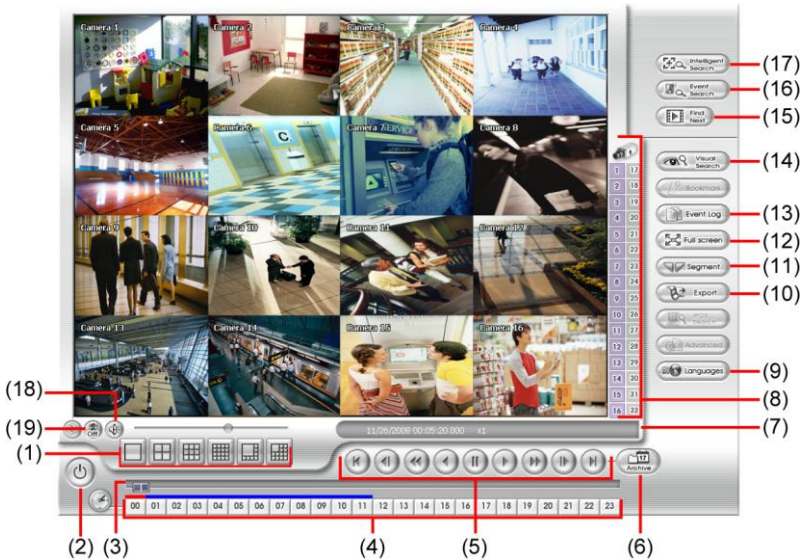

Name	Function
Exit	Close the application
(2) Split Screen Mode	Select from 6 different split screen type to playback the recorded video file of all the camera, or one camera over the other or alongside on a single screen.
i	<ul style="list-style-type: none"> - If there are only 4 cameras, you won't be able to switch to 9, 16, and 13 split screen mode. - To zoom in an area on the screen, Right-click and Drag a square on the screen area you want to enlarge.
(3) Progress bar	Show the progress of the file being played. You may move the bar to seek at any location of the track.
(4) Hour Buttons	Select and click to playback the recorded video file on the specific time frame.
i	The Hour buttons represent the time in 24-hour clock. The blue bar on top of the hour button indicates that there is a recorded video file on that period of time. While the red bar indicates that you are currently viewing the recorded video file.

Name	Function
(5) Playback Control Buttons	<p>Begin: Move at the beginning of the recorded video file.</p> <p>Previous: Go back to the previous frame.</p> <p>Slower: Play the recorded video file at the speed of 1/2X, 1/4X, or 1/8X.</p> <p>Rewind: Wind back the recorded video file.</p> <p>Pause: Briefly stop playing the recorded video file.</p> <p>Play: Play the recorded video file.</p> <p>Faster: Play the recorded video file at the speed of 2x, 4x, 8x, 16x or 32x.</p> <p>Next: Go to the next frame.</p> <p>End: Go to the end of the recorded video file.</p>

- (6) Archive
- Select the date on the calendar and the time from 00 to 23 to where to start playing the recorded video file.
 - **OPEN FILE:** user can open the recorded file from HDD
 - **Channel 01~ 16&Channel 17 ~ 32:** Switch to different channel group of playback calendar.
 - **Day Light Saving:** the playback calendar will show the available video records during day light saving time period.

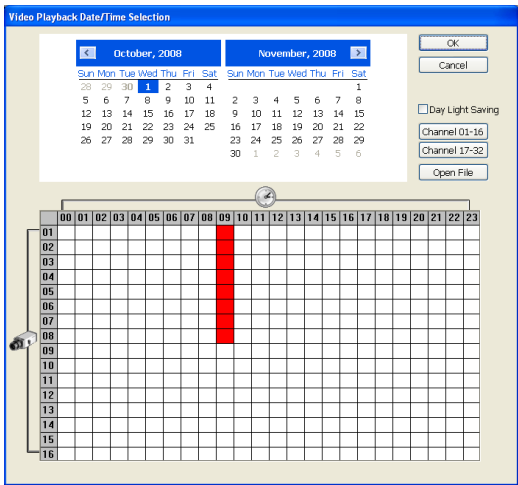

i The numbers from 00 to 23 represent the time in 24-hour clock. The numbers from 01 to 16 represent the camera ID. The blue colored column indicates that there is a recorded video file on that period of time. While the red colored column indicates on where to start playing the recorded video file.

(7) Status bar	Display the recorded date, time and play speed.
(8) Camera ID	Show the number of cameras that are being viewed. When you are in single screen mode, click the camera ID number to switch and view other camera.
(9) Language	Switch the function tip display language.
(10) Export	<p>Export includes Snapshot, Print, Output Video Clip, and Backup function.</p> <ul style="list-style-type: none"> ■ Snapshot: Capture and save the screen shot either in *.jpg or *.bmp format. ■ Print: Print the screen shot. ■ Output Video Clip: Save the segmented file in *.mpg, *.avi, or *.dvr format (see also Chapter 4.8).

Name	Function
------	----------

(11) Segment	Keep a portion of the recorded video (see also Chapter 4.8).
--------------	---

(12) Full screen	View in Playback-compact mode. To return, press the right button of the mouse or ESC on the keyboard or click the arrow icon.
------------------	--



When you switch to full screen in multiple-screen mode, **Left** click to toggle to only display one of the video in the multiple-screen mode or all.



When there are dual monitors with 32 channels, the full screen mode will split into 16 channels on each monitor.

(13) Event Log	When backup, the DVR system will include event logs. User can view the record of activities that take place in the system. To filter the records, select and click the option button to only display Event, System, Operation, Network or POS.
----------------	--

(14) Visual Search	Search from a specific camera by Date, Hour, Minute, 10 Seconds and Second. (See also Chapter 4.10)
--------------------	--

(15) Find Next	Search for the next event or changes in the motion detector frame. You can use this when you are using Intelligent Search or Event Search function.
----------------	---

(16) Event Search	Search from the recorded activities that take place in the system (i.e., Sensor, Motion, Video Loss, POS). (See also Chapter 4.11)
-------------------	---

(17) Intelligent Search	Search the changes in the motion detector frame (See also Chapter 4.12).
-------------------------	---

(18) Audio	Enable/disable volume
------------	-----------------------

(19) De-interlace	To enhance the video quality. Set the de-interlace mode to #1, if you are capturing motionless picture and #2, if it captures lots of movement.
-------------------	---

Chapter 7 Functional Keys and Debug Tool

7.1 Using Functional Keys

The NV DVR system provides shortcut keys. The table shows the function keys and descriptions.

Function Keys	description
Q	Exit System
F1	Display system information
F2	Start recording
F3	Enable network function
F4	Access system settings
F5	Switch to playback mode
F6	Access E-map setting
F7	Access PTZ camera control panel
F8	Snapshot
F9	Switch to Full Screen
F11	Switch to AutoScan
CTRL + F	Freeze function
CTRL + B	Quick Backup
Ctrl + A	Turn on/off hardware AGC (Auto Gain Control)
Ctrl+ N	To call out System information windows included usage of memory, CPU, and network.

7.2 Using Debug Tool

Debug Tool helps user to save a system log report or record all operate processing in order to debug when DVR system has abnormal status occurred. Debug Tool will be install when DVR system is installed. Please go to **start > program > DVR > DVR server > Debug Tool**.

To save a debug log, click to change the save path and click **Report** button to export a debug log file in *.txt format.

Debug Tool can record all operate processing by clicking **Record**. To change the save path, click . To stop the recording, click **Stop**. The Debug tool will record a video file in *.avi format.

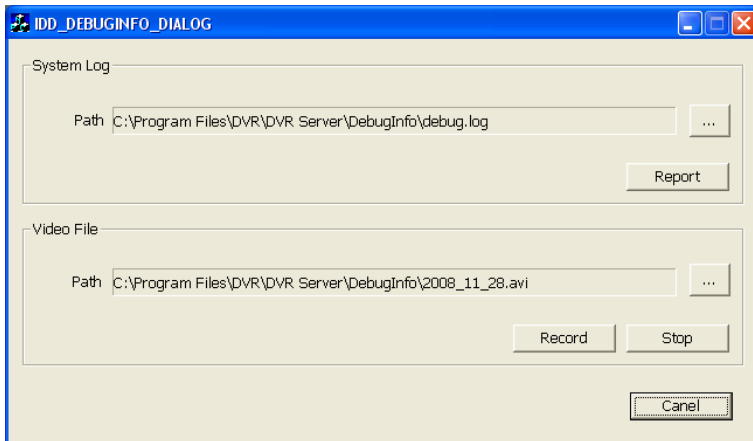

Chapter 8 Using the Remote Programs

You can use Microsoft Internet Explorer to access NV DVR server by entering the IP address or domain name. To use this feature, make sure that you are connected to the internet and the Network feature is enabled.



The DVR site needs to enable **Network**. To enable DVR network, please refer to [Chapter 4.3#\(6\)](#).

Accessing this feature for the first time you will be prompted by your browser to install WebCamX.cab, allow the installation and you should be able to connect and login afterwards.

Click **Install** when the Internet Explorer - Security Warning dialog box appears.

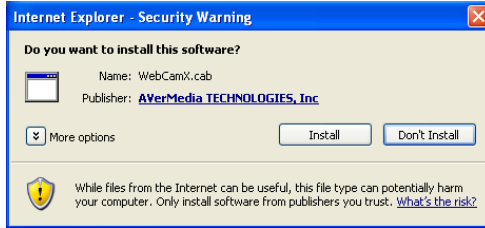

After installing the **WebCamX.cab** and when connecting to the NV DVR server, you are required to enter User ID, password and select the network type. Enable the **Remember Login Information** that DVR system will memorize the login account information.

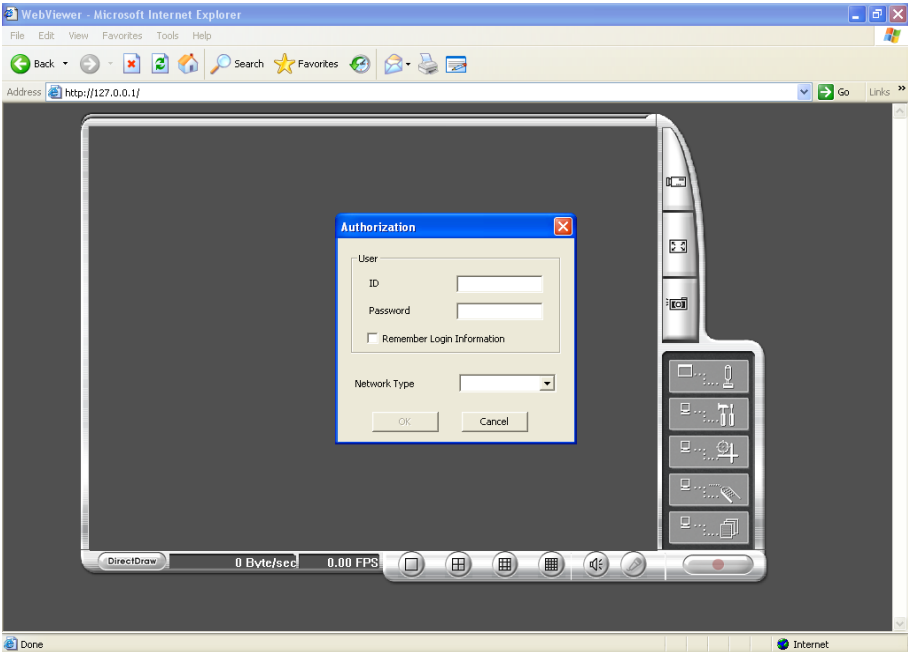

If you are not in a LAN network environment, remote playback video may be un-smooth due to network speed limitation. Slow network transmission speed may possibly cause system performance drop as well.

8.1 Familiarizing the NV DVR WebViewer Buttons

Right-clicking on the webcam video screen, enables you to Start Recording, Video Quality, Select Camera, Enable DirectDraw, and view Server Information.



Name	Function
(1) DirectDraw	Enhance the video quality.
<p>i Not all graphic cards can support this function.</p>	
(2) Received file size	Indicate the size of the data being sent per second.
(3) Camera frames	Indicate the number of frames per second.
(4) Split display mode	Select from six different split screen types to view all the cameras. It also allows you to switch and view different camera number.
(5) Audio	Enable/disable remote sound.
(6) 2-Way Talk	Enable/disable 2-way audio function. This function allows the client and server to talk via internet using MIC. Make sure your microphone and speakers work before using this function. If the NV DVR server Talk to web-client setting is disabled, you won't be able to hear from the other side.
(7) Record	Save the video of the selected camera in AVI format.
(8) Event Log Viewer	Display the Event logs, Operation logs, POS logs, System logs, and Network logs.
(9) Remote Console	Initiate Remote Console. The interface is the same as NV DVR application and allows you to control NV DVR server (see also Chapter 8.3). Remote Console application can be installed from Software CD, too.

i If you are using Windows Vista, please make sure you execute IE as system administrator. To execute IE as system administrator, please right click on IE shortcut icon and select "To execute as Administrator".

Name	Function
(10) Remote E-Map	Display the NV DVR server Emap screen (see also Chapter 4.7).
(11) Remote setup	Change the NV DVR server settings (see also Chapter 8.1.1).
(12) Select a PTZ camera	Initiate PTZ camera controller (see also Chapter 8.2)
(13) Snapshot	Capture and save the screen shot in *.bmp format.
(14) Full screen	Use the entire area of the screen to only display the video. To return, Right click the mouse or press ESC on the keyboard.
(15) Select cameras to view	Select to the view camera from different server. In Select Camera dialog box, Display column, click to enable/disable viewing the camera. In Video Quality column, click to select between High, Normal or Low. <ul style="list-style-type: none"> - Click Add Server and select the server type between DVR and IP Cam to add. - Click Delete Server to delete the selected item. - Click Import to replace it with the previous saved list. - Click Export to save the list. - Click Apply All to change all the camera video quality based on the selected setting. - Click OK to exit.

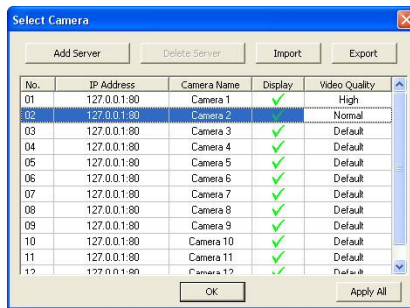

To add IP Cam, user need to enable IP Camera control right at the **User setting** of NV DVR system.(see [5.10](#))

8.1.1 To Setup Remote System Setting

There are two type of remote setup mode – Basic Setting and Advance Setting. Select the setup mode and click **OK** to enter setup window.



Basic Setting

Click **OK** to exit and save the setting and **Cancel** to exit without saving the setting. The setting here applies to Remote DVR only.



Some of settings are not available to the IP camera.

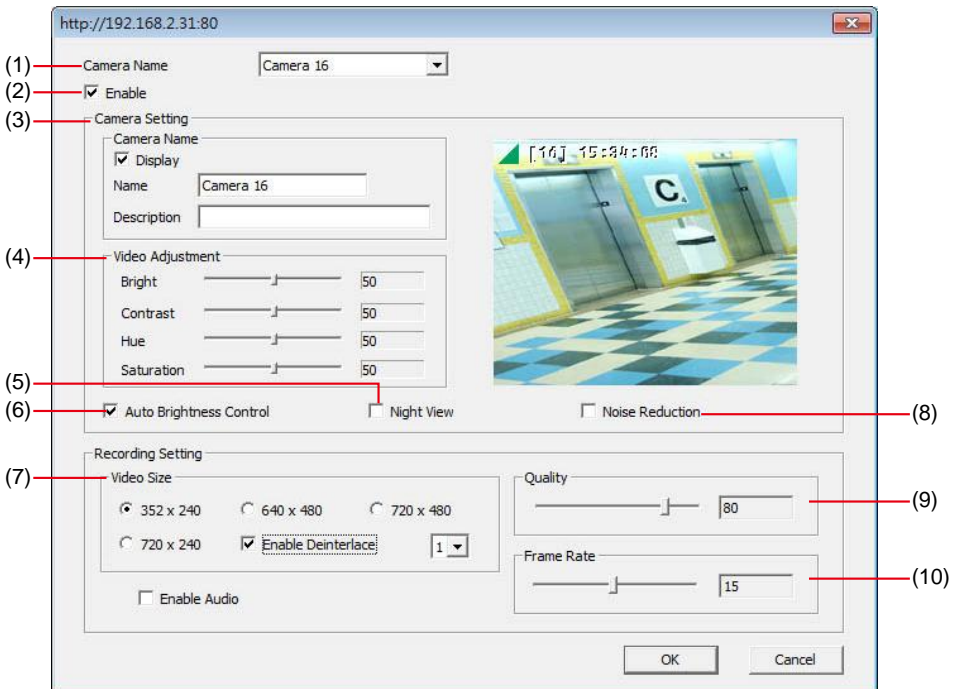

(1) Camera Name

Select the camera you want to adjust the settings.

(2) Enable

Set to enable/disable the selected camera. When there is no video source on the camera, we suggest disabling it so that the system won't detect it as video loss error.

(3) Camera Setting

- Display

Enable/disable to show the video. Even if the video of the selected camera is hidden you can

still record the video and preview it in playback mode.

- **Name**
Change the camera name.
- **Description**
Add a short comment.

(4) Video Adjustment

Adjust the Brightness, Contrast, Hue and Saturation of the selected camera.

(5) Night View

Automatically adjust the exposure to make the image more visible especially when the site is dark. You can only use this function when the Auto Brightness Control is enabled.

(6) Auto Brightness Control

Automatically adjust the brightness.

(7) Noise Reduction

Reduce undesirable video signal and improve the quality of the video.



Noise Reduction uses lots of CPU resource. Please use this feature only if it is really necessary.

(8) Recording Setting

- **Video Size**
Select the size of the video and click the  button. The higher the size, the larger the file it create. You can also activate the **Enable Deinterlace** to enhance the video quality. Set the **Enable Deinterlace** mode to #1, if you are capturing motionless picture and #2, if it captures lots of movement.
- **Enable Audio**
Select to assign the audio channel of the selected camera. You can only assign one audio channel to one camera source. This way you can record both audio and video.

(9) Quality

Adjust the video quality. The higher the value, the lower the compression level and uses more hard disk space.

(10) Frame Rate

Set the number of images per second of the video to be recorded. The frame rate ranges from 1 to 30 for NTSC and 1 to 25 for PAL. The higher frame rate, it uses more hard disk space.

Advance Setting

In Advance setting, user can configure remote DVR in more detail.

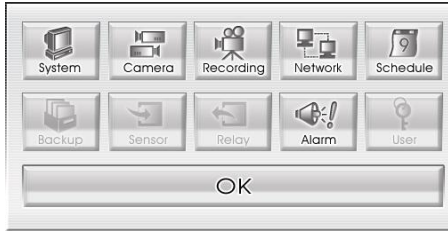

System Setting

In the System Setting windows, click **Update** to accept the new settings, click **Exit** to exit without saving, and click **Default** to revert back to original factory setting.

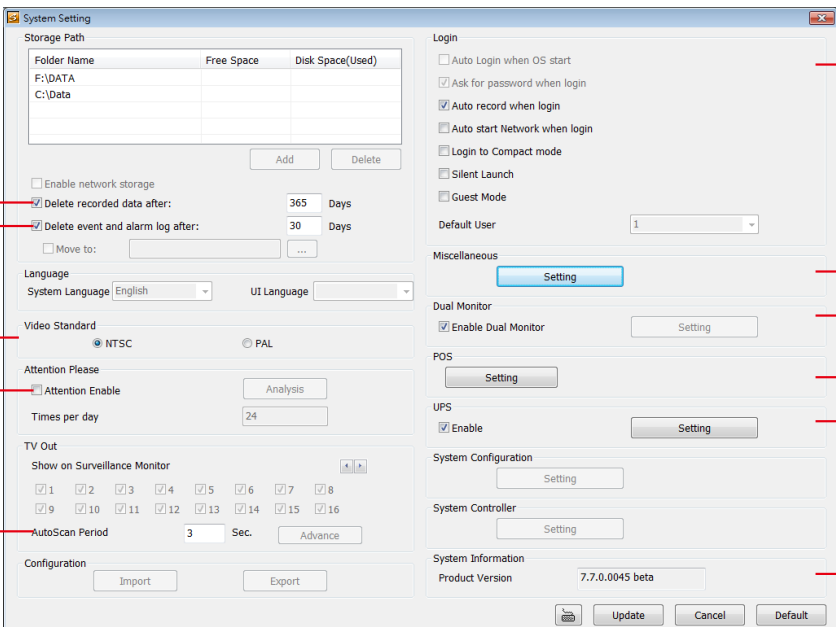

The screenshot shows the 'System Setting' window with the following settings highlighted by numbered callouts:

- (1) Delete recorded data after: 365 Days
- (2) Delete event and alarm log after: 30 Days
- (3) Video Standard: NTSC, PAL
- (4) Attention Please: Attention Enable, Analysis button, Times per day: 24
- (5) TV Out: Show on Surveillance Monitor (checkboxes 1-16), AutoScan Period: 3 Sec, Advance button
- (6) Login: Auto Login when OS start, Ask for password when login, Auto record when login, Auto start Network when login, Login to Compact mode, Silent Launch, Guest Mode, Default User: 1
- (7) Miscellaneous: Setting button
- (8) Dual Monitor: Enable Dual Monitor, Setting button
- (9) POS: Setting button
- (10) UPS: Enable, Setting button
- (11) System Configuration: Setting button, System Controller: Setting button, System Information: Product Version 7.7.0.0045 beta

(1) Delete recorded data after

If you want the system to automatically erase the data after a certain days, enable the **Delete recorded data after** check box and enter the numbers of days in **Days** text box.

(2) Delete event and alarm log after

If you want the system to automatically erase the event and alarm log files after a certain days, enable the **Delete event and alarm log after** check box and enter the numbers of days in **Days** text box.

(3) Video Standard

Change and select the proper video system according to your camera video system. If the video system setting is wrong, the video would appear abnormal.

(4) Attention Please

Check the attentiveness of the person who is monitoring the system. You may set the number of times the Attention dialog box to appear in a day in **Times per day** text box.

When this feature is enabled, the **Attention** dialog box would appear. The person who is monitoring

the system must enter the same number that appears from the left box at the right text box and then click **OK**.

(5) AutoScan Period

Set the display time gap from 3 to 10 sec. before it switches to the next camera.

(6) Login

Enable the conditions in Login section you want the system to automatically carry out.

- **Auto record when login**
Automatically start video recording when the NV DVR is executed.
- **Auto start Network when login**
Automatically connect to network when the NV DVR is executed.
- **Login to compact mode**
Switch to compact mode directly when the NV DVR is executed.
- **Silent Launch**
Enable the DVR system minimizes on the system tray automatically right after start up.
- **Guest Mode**
Automatically log in Guest mode when the NV DVR is executed. In guest mode, the functions are limited to preview and playback only.

(7) Miscellaneous

Enable the conditions in **Miscellaneous** section you want the system to perform.

- **Desktop Lock**
 - ✓ **Block window OS hotkey:** Deactivate the [Ctrl-Alt-Del] and [Windows] keyboard key functions.
 - ✓ **Block windows OS pop-up window:** To block any pop-up window from windows system.

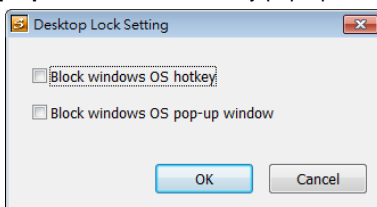

- **Beep if no signal**
Make sound when the video signal is lost.
- **Mandatory Record**
Always record video when software is running
- **Enable Overlay**
To enhance video signal for better video quality.



Enable overlay doesn't support on NV3000T and NV5000 card.

- **Screen Saver**
Set a period time to enter screen saver mode when system idle.
- **Auto Scan Period**
Set the time gap of the Auto Scan function from 3 to 10 seconds. This automatically switches to the next video in cycle depending on the set time gap.
- **Playback Mode**
Select the mode of playback the video.
 - ✓ **Select date and time:** Select the date and time which user wants to playback.
 - ✓ **Play the last file:** Automatically playback the video from the last hour
 - ✓ **Instant Playback:** Automatically playback the video which has just recorded
- **Date Format**
Select the date format which wants to display in **Select date and time** playback mode

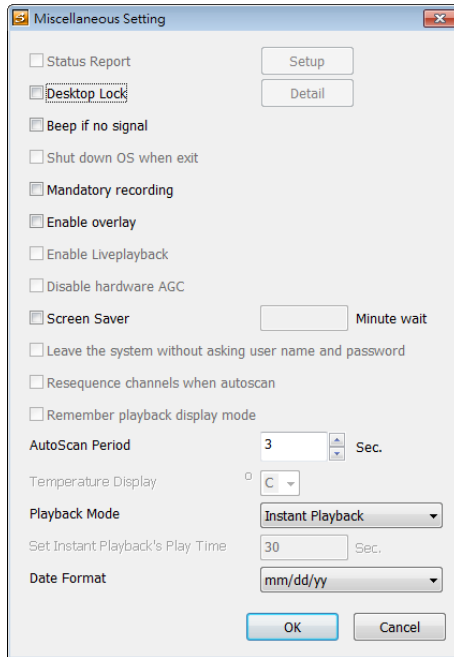

(8) Dual Monitor

To enable/disable dual monitor function.

(9) POS

Set from which camera screen to display the data from the POS equipment. Click **Setting** to enter the setup window.

■ Advanced Setting

To setup POS text display position, text font and color.

1. In the System Setting dialog box, POS section, click **Setting >> Advanced Setting**
2. Mark **Show POS Text** to allow POS data to be display on surveillance screen.
3. Select the POS data display position on surveillance screen – Left-Top, Left-Bottom, Right-Top, or Right-Bottom.
4. Mark **Multiple Windows** to allow more than one iPOS live data window (see also [iPOS Live](#) in Preview mode) display on the preview screen mode.
5. Mark **Save Window Position** that iPOS live data window position(see also [iPOS Live](#) in Preview mode) will be saved as next time call out position when close
6. Select the **Cameras** of iPOS live data that want to be display on Preview mode. To select all

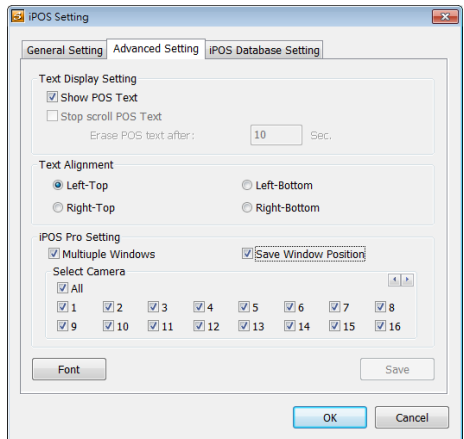

cameras, mark **All**.

7. To change the POS data font and color, click **Font**.
8. When it is done, click **Save** to complete the configuration.

■ POS Database Setting

Mark **Remove POS data after** the POS data will be delete from DVR hard disk on the day that user has setup.

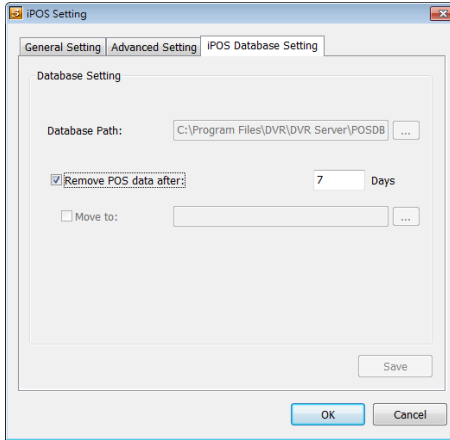

(10) UPS (Uninterruptible Power Supply)

Protect the system from damaging, such as power surges or brownouts. This automatically gives time to close the NV DVR properly when the battery backup power has reached the Shutdown when capacity below percentage level setting.

The UPS device must be connected to your computer (refer to your UPS user's guide).



The UPS application must meet Windows XP or Windows Vista system requirements.

(11) System Information

Display current NVR system firmware version.

Camera Setting

Select the camera from remote DVR servers to modify settings. In the Camera Setting windows, click **Update** to save and apply the new settings, click **Exit** to exit without saving, and click **Default1/Default2** to revert back to original factory setting.



Some of settings are not available to the IP camera.

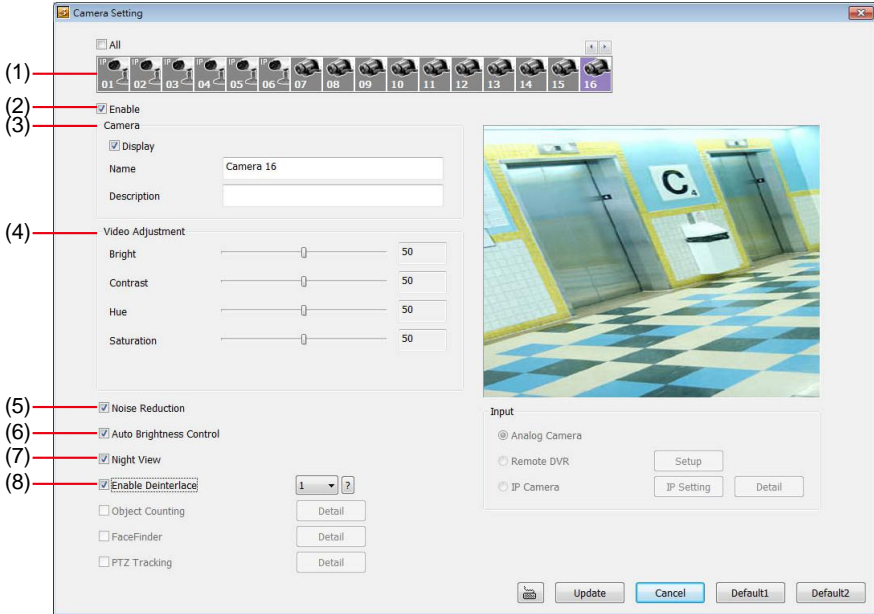

(1) Camera Icons

Select the camera number you want to adjust the video setting. To select all the cameras, enable the **ALL** check box. To select more than one camera, Right click on the camera icon. To select one camera only, Left click on the camera icon. The camera icon turns red when it is selected.

(2) Enable

Set to enable/disable the selected camera. When there is no video source on the camera, we suggest disabling it so that the system won't detect it as video loss error.

(3) Camera

- **Display**
Enable/disable to show the video. Even if the video of the selected camera is hidden you can still record the video and preview it in playback mode.
- **Name**
Change the camera name.
- **Description**
Add a short comment.

(4) Video Adjustment

Adjust the Brightness, Contrast, Hue and Saturation of the selected camera.

(5) Noise Reduction

Reduce undesirable video signal and improve the quality of the video.



Noise Reduction uses lots of CPU resource. Please use this feature only if it is really necessary.

(6) Auto Brightness Control

Automatically adjust the brightness.

(7) Night View

Automatically adjust the exposure to make the image more visible especially when the site is dark. You can only use this function when the ***Auto Brightness Control is enabled***.

(8) Enable Deinterlace

To enhance the video quality. Set the deinterlace mode to #1, if you are capturing motionless picture and #2, if it captures lots of movement.

Record Setting

In the Recording setup windows, click **OK** to accept the new settings, click **Exit** to exit without saving, and click **Default** to revert back to original factory setting.



Some of settings are not available to the IP camera.

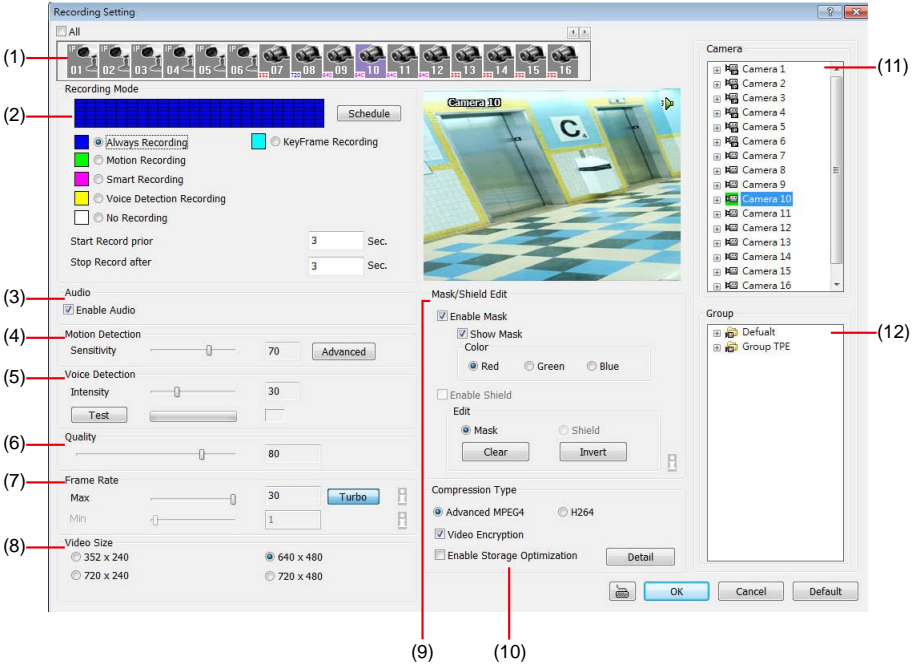

(1) Camera Icons

Select the camera number you want to set the recording setting. To select all the cameras, enable the **ALL** check box. To select more than one camera, **Right click** on the camera icon. To select one camera only, **Left click** on the camera icon. The camera icon turns red when it is selected.

(2) Recording Mode

The blocks from 00 to 23 represent the time in 24-hour clock. To record in full 24 hours, select the recording mode and click the **⊙** button. If you want to only record at a particular time, click the colored block beside the recording mode then click on the time blocks. When the system starts recording a red triangle mark would appear at the upper left corner of the screen. The recording modes are listed below:

- **Always Recording**
Record the video from the selected camera and save it to the designated storage path
- **Motion Recording**
Start recording the video from the selected camera only when the system detects movement. Once a motion is detected, the system automatically saves the previous frames and stop based on the **Start Record Prior** and **Stop Record After** settings.
- **Smart Recording**
Automatically switch to recorded at the maximum frame rate setting once a motion is detected and if there is no motion, it records at the minimum frame rate setting. Set the maximum and minimum frame rate setting in [\(6\) Frame Rate](#) section.
- **Vovice Detection Recording**
DVR system will record when the voice exceeds the intensity value in **Voice Detection** setting.

- **No Recording**

The system won't do any recording.

(3) Audio

Select to assign the audio channel of the selected camera. You can only assign one audio channel to one camera source. This way you can record both audio and video.



An Audio I/O card is required to use this function.

(4) Motion Detection

Adjust the sensitivity of the motion detector. The higher the value, the finer the sensitivity is detected. When it detects a motion, a green triangle mark would appear at the upper left corner of the screen.

(5) Video Detection

Adjust the intensity of the audio detector. The system detects sound when it exceeds the intensity value.

(6) Quality

Adjust the video quality. The higher the value, the lower the compression level and uses more hard disk space.

(7) Frame Rate

Set the maximum number of frames to be recorded during motion and motionless state. The frame rate ranges from 1 to 30 for NTSC and 1 to 25 for PAL. The higher the frame rate, it uses more hard disk space.

(8) Video Size

Select the size of the video and click the  button. The higher the size, the larger the file it create.

(9) Mask/Shield Edit

Mask, mark an area on the screen to disregards the motion in the marked area and to only monitor outside the marked area. In the Mask/Shield Edit section, activate the **Enable Mask/Enable Shield** check box. Click and drag a frame on the screen to create Mask area.

(10) Compression Type

User can refer the table below to check the NV card supports what type of compression. H264 is the latest and advanced video compression format that delivers better video quality and smaller file size but this uses more CPU resource. Advanced MPEG4 and MJPEG, both provide a standard for color picture compression rate. MPEG4 uses higher compression rate and smaller file size. While MJPEG uses slightly lower compression rate and bigger file size.

	MPEG4	MPEG 4 Encryption	H264	H264 Encryption	MJPG
NV3000T	✓	✓	✓	✓	✓
NV5000	✓	✓	✓	✓	✓
NV6000T	✓	✓	✓	✓	
NV7240	✓				
NV7480	✓				
NV8416T	✓		✓		
NV9416T			✓		

■ Video Encryption



When NV7480 card has enabled one channel encryption, the all channels will be encrypted.

Enable/disable to encrypt the recorded video that way only the person who knows the password can clearly view the video playback. The file size would become 10 to 30% more. Enabling the Video Encryption check box, you will be prompted to enter the password and retype the password for confirmation. Make sure not to forget the password for you would not be able to decrypt the video without it.

Video Encryption

Enter Password:

Confirm Password:

 Show Password

Warning:

Kindly note down your password. It is not possible to decode video stream without valid password. Password once lost cannot be recovered.

OK Cancel

The  symbol would appear on the upper right corner of the encrypted video screen. You may see the video during live recording. To decrypt the video, please refer to [Chapter 5.3.3](#).



■ Enable Storage Optimization

Enable/disable to save more storage space. Click **Detail** button to select the type of storage optimization.

- ✓ **Monochrome Mode:** The video will record in black and white.
- ✓ **Noise Reduction:** To do the noise reduction before compression.
- ✓ **Disable Video Enhancement:** To shutdown video enhancement function.

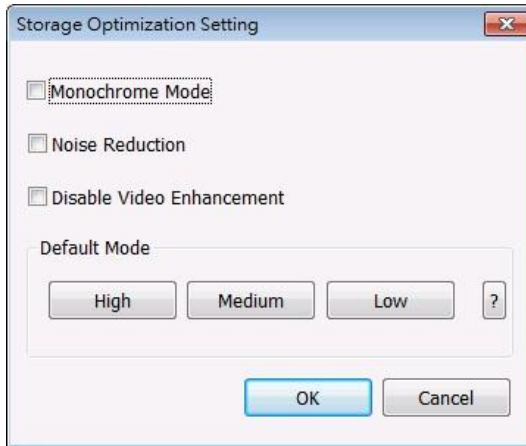

User also can select the Default Mode High/Medium/Low. Click ? button to view default mode definition.

(11) Group

Click to view the camera group that user has been setup in **Camera setup** (see also [Chapter 5.2.4](#)).

(12) Camera

Click to view the camera live video on screen.

Network Setting

In the Network Setting dialog box, click **Update** to accept the new settings, click **Exit** to exit without saving, and click **Default** to revert back to original factory setting. For the network service ports that use by DVR server, please see [Appendix C](#).

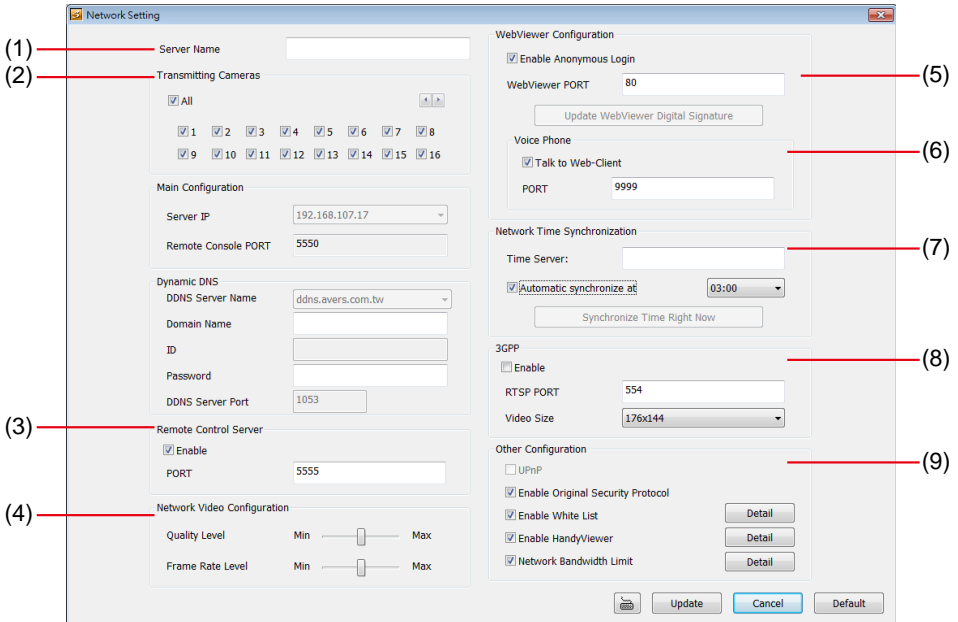

(1) Server Name

Assign a name for the DVR unit. Letters of the alphabet and numbers only.

(2) Transmitting Cameras

Select and click on the camera number in the Transmitting Camera section you want to make it accessible via internet using WebCam, Remote Console, PDA Viewer and Hand Viewer (still image). To select all the cameras, enable the **ALL** check box.

(3) Remote Control Server

Enable/disable remote control from remote application (ex. CMS). Enter the remote accessing port in **Port** column.

(4) Network Video Configuration

Set up the video quality and frame rate for viewing and transmitting to the remote program. Scrolling adjust bar to set the **Quality level** and **FrameRate level**.

(5) WebCam Port

Activate **Enable Anonymous Login** to remotely access the DVR server without the need of password. The default of WebCam port is 80.

(6) Voice Phone

Voice Phone is a 2-Way Talk feature that allows the client and server to talk via internet using microphone. Make sure both microphone and speakers work before using this feature. If the **Talk to Web-Client** is disabled, the person in the DVR server side can only hear the voice from the client side that is when the WebCam 2-Way Talk button is activated. (See also [Chapter 8.1 #6](#)). The default port of voice phone is 9999.

(7) Network Time Synchronization

Adjust the DVR system time same as network time server. Fill in the **Time Server** IP address or

domain name. Select **Automatic Synchronize** time to set automatic synchronize time on a daily basis.

(8) 3GPP

Enable 3GPP that allows user to use browser on the mobile phone to view recorded video. Just enter http://DVR_Server_IP/3GPP on the browser of mobile phone, and then, user will receive the recorded video from DVR server. Fill the RTSP PORT for 3GPP connection. Select the video size for transmitting to user's browser on the mobile phone.

(9) Other Configuration

- Enable Original Security Protocol

Enable new version DVR system to accept remote software with former version. For example, if user uses CMS version 7.1 and connect to NV DVR server with version 7.3, and then, user has to enable this option to make it work. It is due to that DVR system has some new security protocol in DVR with version 7.3 and newer version, and it's not compatible with old remote software.

- Enable White List

An access permit list for the remote accessing of DVR server. Enter the IP address and click **Add**. Or, enter a range of IP address and click **Add**. To delete the IP from the list, select the IP and click **Delete** button. To reset the input, click **Clear** button.

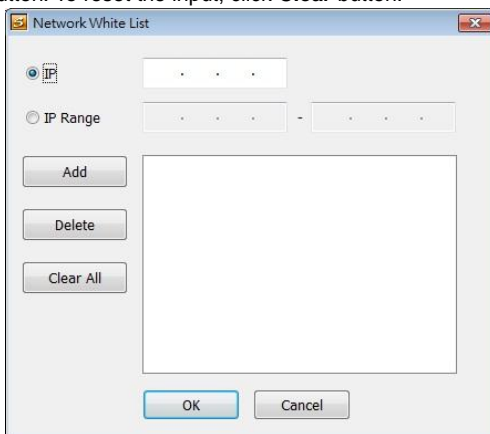

- Enable HandyViewer

Enable remote users to use a PDA or a mobile phone to access DVR server and select the video size and quality. (See also [Chapter 8.5](#) and [8.6](#))

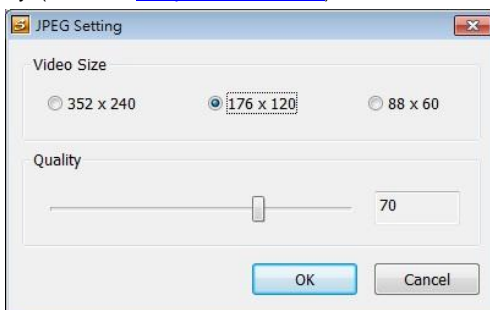

- **Network Bandwidth Limit**

- ✓ **By Channel:** Set the network bandwidth by each channel.
- ✓ **All:** Set the total network bandwidth consumption limit.

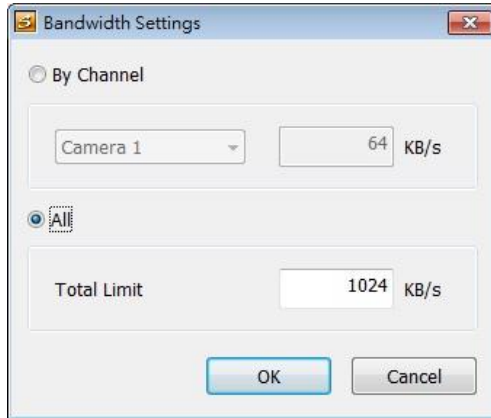

Schedule Setting

Schedule to record, backup, enable network, reboot and disable alarm of all the cameras either weekly or one time. The number from 00 to 23 represent the time in 24-hour clock. The left most column display the days in a week.

Calendar view showing October and November 2010. The date 10/12/2010 is selected. The 'Record' dropdown is set to WEEKLY.

	00	01	02	03	04	05	06	07	08	09	10	11	12	13	14	15	16	17	18	19	20	21	22	23
10/10 Sun																								
10/11 Mon																								
10/12 Tue																								
10/13 Wed																								
10/14 Thu																								
10/15 Fri																								
10/16 Sat																								

To Set the Schedule Setting:

1. Select the date in the calendar. Use and buttons to shift the calendar to the left or right.
2. Select the condition you want to schedule in the drop down list.

- Record

Activate all the cameras to start video recording at the set time based on the Recording setting (see also [Chapter 5.3](#)).

- **Backup**

Save another copy of all the data at the set time and specified backup path. NV DVR automatically updates and only backup the data that are not yet included in the archive. To assign backup path, click .

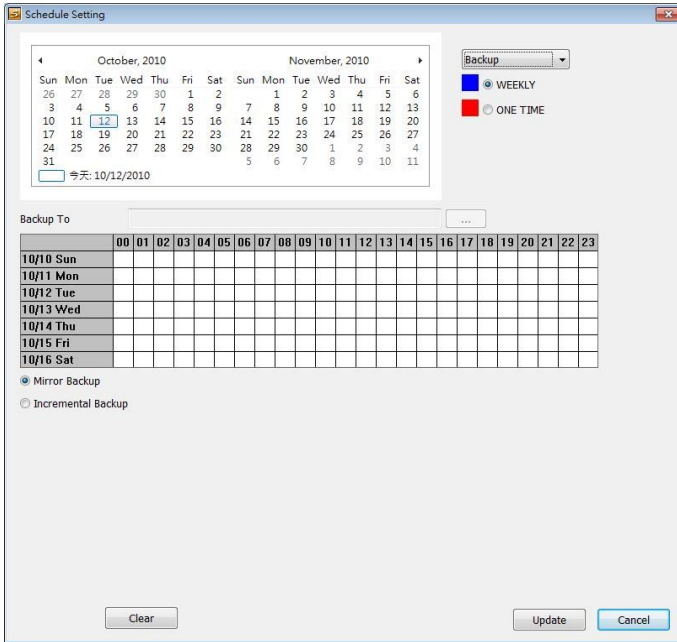

- ✓ **Mirror Backup:** Save a copy of all the data at the set time and specified backup path.
- ✓ **Incremental Backup:** Only backup the data that are not yet included in the archive from last time.



Make sure the backup folder and storage folder are not on the same drive.

- **Network**

Activate NV DVR remote system to access at the set time. After the appointed time, the Network function will be disabled. If the Network function is already enabled, the Network function will not be disabled when the appointed time has ended.

- **Reboot**

Restart the PC at the appointed time.



Make sure the Windows operating system is set **NOT** to require you to login user name and password. This way the system will be able to run NV DVR program.

- **Disable Alarm**

Deactivate the alarm at the set time temporarily.

3. Specify to either schedule it weekly or one time. Click to make a selection.
4. Click on the blocks to set the schedule (see also [Chapter 5.5.1](#)). Or click **All** to select all. To store the setting, click **Save**. To remove the settings, click **Clear**.
5. To end Schedule Setting, click **Update** to exit and accept the setting and **Exit** to exit without saving the setting.

Alarm Setting

In the Alarm Setting dialog box, click **Add** to insert and set new alarm setting, click **Delete** to remove the selected alarm setting, click **OK** to exit and save the setting, **Cancel** to exit without saving, and **Default** to revert back to original factory setting.

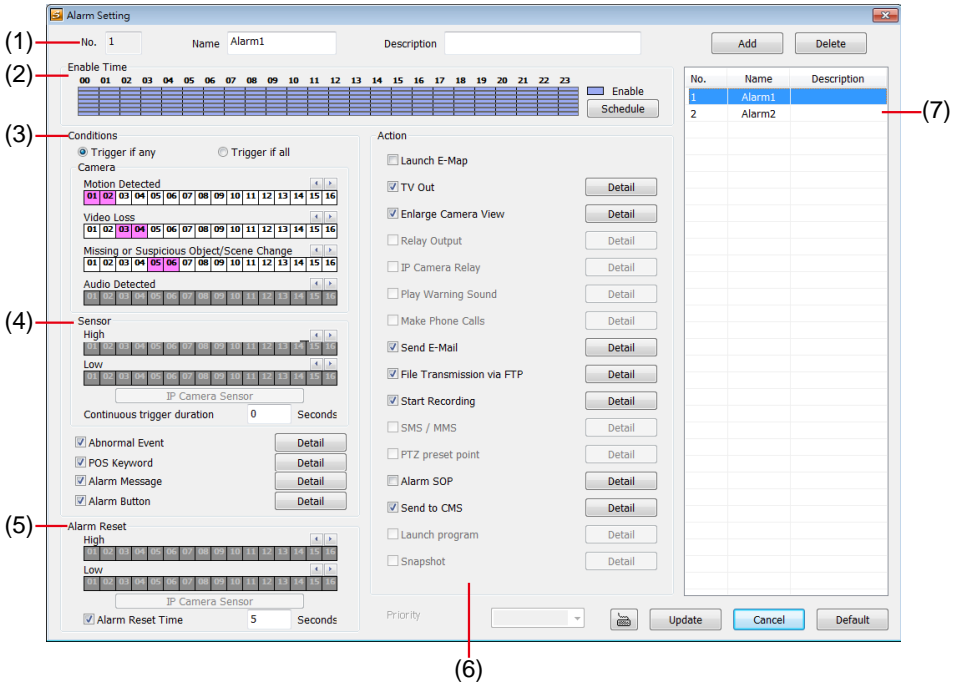

To set the Alarm Setting:

1. Click **Add** to insert and set a new alarm setting. Click the items in the **(7) Alarm Setting List**, if you want to modify the alarm setting.
2. In **(1) Alarm Setting number/Name/Description**, display the selected alarm setting number in the list below. Enter alarm name and description.
3. In **(2) Enable Time**, the number from 00 to 23 represent the time in 24-hour clock. Select the time and click the block you want to activate or deactivate the alarm function. When it is deactivated the color of the block turns white.
4. In **(3) Conditions**, you can set “**Trigger if any**” to activate if it falls to one of the conditions or “**Trigger if all**” to activate if it falls to all conditions.
 - In Camera section, select and click on the camera number (01 to 16) in **Motion Detected** and **Video Loss** to set the condition for the system to alarm.
 - In **Missing and Suspicious Object Detected**, click the camera number (01 to 16) and select the certain object on the screen (right click on camera number for detailed setting)), and when the certain object is missing or doubtful, the system will alarm. (see also [Chapter 5.9.12](#)) In **Scene Change**, when the camera has been moved, the system will alarm, too.
 - In **Voice Detection**, click the camera number (01 to 16) to the system to alarm when detect the abnormal voice.
5. In **(4) Sensor**, select and click on the sensor number (use ◀ and ▶ to select the sensor) to set the condition for the system to alarm. If the sensor normal status is high, set the sensor condition to low (see [Chapter 5.7 step #4](#)).
 - Enable/disable the **Abnormal Event** check box, to set the condition of the event for system to alarm.

- **System Reboot:** when the DVR system reboot without abnormal condition, the system will send out the alarm message.
- **Abnormal Reboot:** when the DVR system reboot in irregular condition, the system will send out the alarm message.
- **Recording is switched off:** when the recording has been stopped, the system will send out the alarm message.
- **Network is switched off:** when the network connection of DVR system is lost, the system will send out the alarm message.
- **Hard Disk failed:** when the hard disk can't work normally, the system will send out the alarm message.
- **Temperature:** set a temperature limited of system for system to alarm. When DVR system temperature is over the temperature limited, the DVR system will send out the alarm.
- **VGA Temperature:** set a VGA temperature limited for alarm. When VGA temperature is over the limited that user has set, the DVR system will send out the alarm.



Temperature setting doesn't support on NV3000T/5000 card.

- **Illegal Entry:** any objects move between selected regions which user has set up in **Object Counting** section (see also [Chapter 5.2.1](#)), the system will send out the alarm. Select the entry (object moves from region 1 to 2 or from region 2 to 1) and camera for system alarm detection.

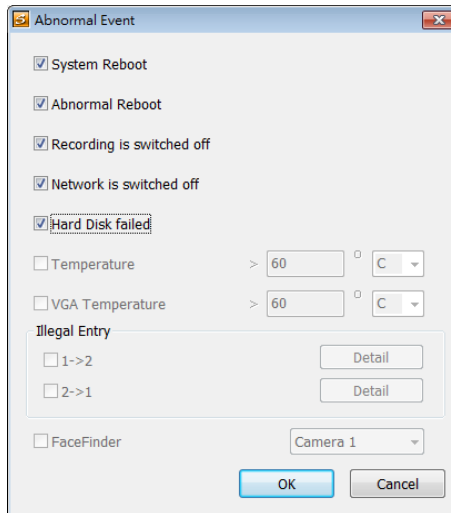

- Enable/disable the **POS Keyword** check box, to scan the data from the POS if it matches the keyword (see also [Chapter 5.9.11](#)).
 - Enable/disable the **Alarm Message** check box, to active with external alarm message by your own program. For the detail configuration, please contact the local reseller.
6. In **(5) Alarm Reset**, click the camera number (use ◀ and ▶ to select the alarm) to set the reset condition of alarm. Once alarm is reset, all alarm action will stop at the moment. If the sensor normal status is high, set the sensor condition to low.
 7. In **(6) Action**, you may now set the alarm action for the system to perform when the alarm condition is activated.
 - **Launch E-Map**
Display mini Emap screen.
 - **TV Out**

- Switch to only display the video on TV from where the alarm is activated.
- **Enlarge Camera View**
Switch to only display video in Preview/Advanced mode from where the alarm is activated.
- **Send E-mail**
Send an electronic text message. To setup click **Detail** (see also [To Setup Send E-mail](#)).
- **File Transmission via FTP**
Upload file to remote computer thru FTP (File Transfer Protocol). To setup click **Detail** (see also [To Setup FTP](#)).
- **Start Recording**
Record the video from the selected camera. To setup click **Detail** (see also [To Setup Alarm Recording](#)).
- **Alarm SOP (Standard Operation Procedure)**
List the instructions to inform the person of what to do when the alarm is activated. To setup click **Detail** (see also [To Setup Alarm SOP](#)).
- **Send to CMS (Central Management System)**
Enable/disable the selected camera to send video to CMS when the alarm is activated (see also [To Setup CMS Setting](#))

To Setup Send E-mail Setting

Beside the Send Email check box, click **Detail**. In the E-mail Setting dialog box, click **OK** to exit and save the setting and **Cancel** to exit without saving the setting.



Gmail is supported now.

- **Mail Server**
Enter the SMTP Server and port. If your e-mail system requires user identification, enable **Authentication** check box and enter User ID and Password.
- **Mail**
To check if it is working, click **Test Account** button.
 - ✓ **From:** Enter the sender e-mail address.
 - ✓ **To and CC:** Enter the recipient email address and separate it with comma or a semicolon (;).
 - ✓ **Subject:** Enter the message title.
 - ✓ **Message:** Type the message.
- **Email Notice Setting**
 - ✓ **Notice Interval:** Set the period of time before it sends another e-mail notice.
 - ✓ **Embedded image:** Select the sending image's size and set the number of frames.
 - ✓ **Attach image when sensor is triggered:** When the sensor is triggered, the system will capture the image and send the image to the certain e-mail address with the alarm message.



If the alarm is not triggered by sensor, the system will depend on the setting of motion detected, video loss, audio detect, and sensor in alarm setting to send the alarm image and alarm message.

- Modem Dial up Setting

User may set the time to disconnect automatically, just enable the **Auto Disconnect after** check box and set time.

To Setup FTP Setting

1. Beside the File Transmission via FTP check box, click **Detail**.
2. In the FTP Setting dialog box, enter the FTP IP, port, user ID and password.
3. In **Number of Pic** text box, enter the number of sequence images that want to send when file is transmitting. The maximum number of picture can be transmitted are 16.
4. If user wants to send the recorded image before alarm occurs, enter the time that before alarm occurs in **Before alarm(sec.)**.
5. **Upload image:** User needs to select the camera that the images will be capture and send when the any alarm is triggered.
6. Click **OK** to exit and save the setting and **Cancel** to exit without saving the setting.

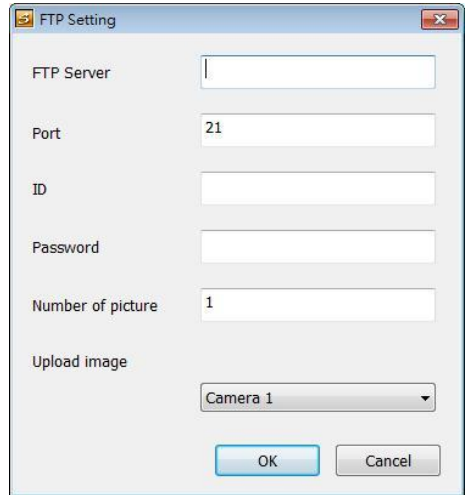

To Setup Alarm Recording Setting

1. Beside the Start Recording check box, click **Detail**.
2. In the Alarm Recording Setting dialog box, select the camera to enable/disable video recording. Enable **All** to select all cameras.
3. In the Frame Rate selection, select **As Setting** to record the number of frames based on the Recording Setting or **Max** to record the maximum of frames based on the available speed.
4. In the **Start Recording prior** text box, mark and set the number in second for the program to pre-recording before the alarm happen. The time range is 1~10 seconds.

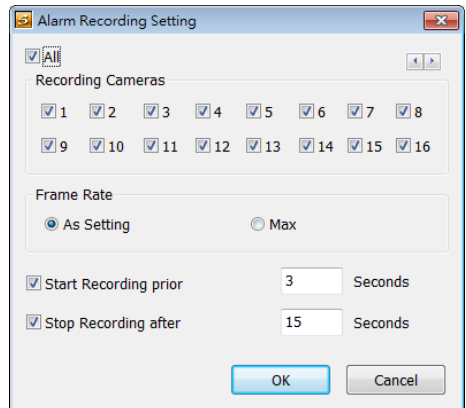

- When camera is Analog or IP camera and recording resolution less or equal to D1, the DVR system only record in key frame for pre-recording.
- When camera is Mega-pixel IP camera and the recording resolution is greater than D1, the DVR system won't do any pre-recording.

5. In the **Stop Recording after** text box, mark and set the number in second for the program to

continue recording after the alarm has ended. The time range is 1~600 seconds. If user doesn't mark and set the time, the alarm recording will continue recording until alarm is reset.

6. Click **OK** to accept the new settings and **Cancel** to exit without saving.

To Setup Alarm SOP

Beside the Alarm SOP check box, click **Detail**. In the step text boxes, type the standard protocol when the alarm is activated. When the alarm is activated, the Standard Operation Procedure dialog box will appear. Just click **Next** to see the next instruction, **Back** to see the previous instruction, **Finish** to end and **Abort** to terminate.

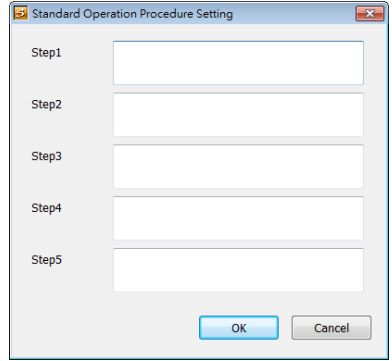

To Setup CMS Setting

Beside the Send to CMS check box, click **Detail**. Click **OK** to accept the new settings and **Cancel** to exit without saving.

- **CMS:** Select the camera to enable/disable sending the video to CMS.
- **Matrix:** Select the camera to enable/disable sending the alarm event video to CMS. The CMS site need to setup a matrix channel to receive the alarm event from DVR server site (please refer to CMS manual for detail)

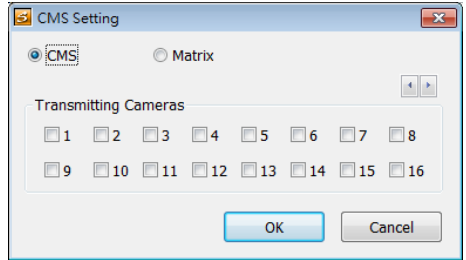

8.2 Familiarizing the WebViewer PTZ Buttons

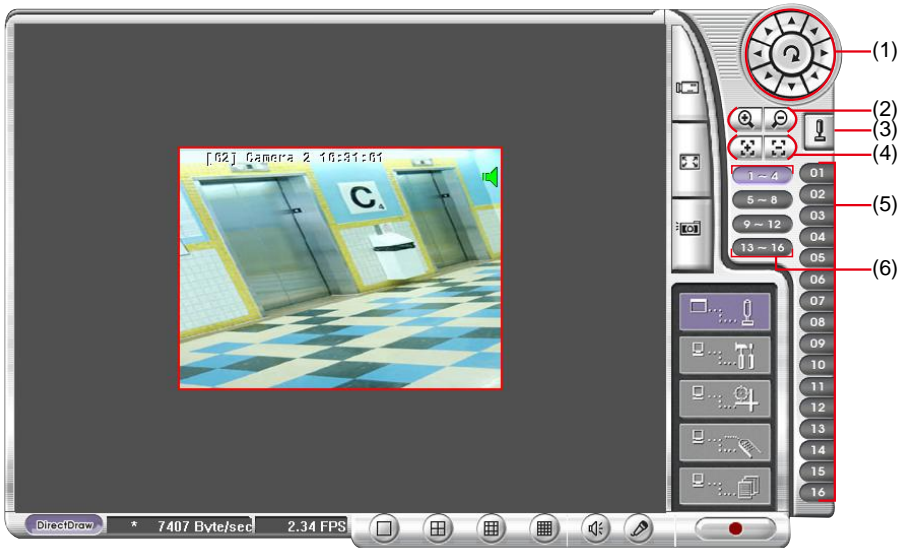

Name	Function
(1) Direction buttons	Adjust and position the focal point of the PTZ camera. Click the center to pan automatically.
(2) Select PTZ	Choose to enable/disable the PTZ camera. In the Select PTZ dialog box, Select column, click to enable/disable viewing and controlling the PTZ camera. Click OK to exit and save the setting and Cancel to exit without saving the setting.
(3) AutoPan Groups	Operate the PTZ cameras automatically based on the selected camera group preset position number.
(4) Camera preset position number	Move the PTZ camera to the preset point.
(5) Zoom +/-	Zoom in and out the image.
(6) Focus +/-	Adjust the focus manually to produce clear image.

8.3 Familiarizing the Remote Console Buttons

Remote Console application can be installed from Software CD, too.

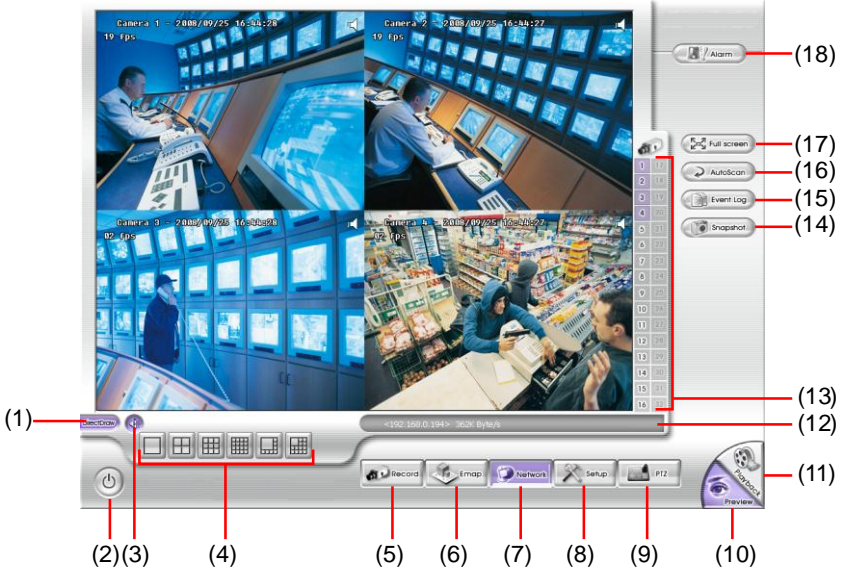

Name	Function
(1) DirectDraw	Enhance the video quality.

i Not all graphic cards can support this function.

(2) Exit	Close the Remote Console.
(3) Volume	Enable/disable the sound.
(4) Split Screen Mode	Select from 6 different split screen type to playback the recorded video file of all the camera, or one camera over the other or alongside on a single screen.

i

- If there are only 4 cameras, you won't be able to switch to 9, 16, and 13 split screen mode.
- To change the video quality, right-click on the screen and select between High, Normal or Low.

(5) Record	Start/stop video recording.
(6) Emap	Display the map in each area, the camera/sensor/relay location and the warning event. (see also Chapter 4.7)
(7) Network	Enable/disable remote system access. This feature allows you to access NV DVR server from a remote location via internet connection.
(8) Setup	Configure the Remote Console setting. (see also Chapter 8.3.1)
(9) PTZ	Access PTZ control panel. Beside PTZ camera, NV DVR system also support mega pixel IP camera.(see Chapter 8.4)
(10) Preview	Switch to Preview/Advanced mode. This allows you to view live camera display.
(11) Playback	Switch to Playback mode. This allows you to view the recorded video file. (see Chapter 8.5)

Name	Function
(12) Status Bar	Display the current date, time and hard disk free space.
(13) Camera ID	Show the number of cameras that are being viewed. When you are in single screen mode, click the camera ID number to switch and view other camera.
(14)Snapshot	Capture and save the screen shot either in *.jpg or *.bmp format.
(15) Event log	Show the record of activities that take place in the system. To filter the records, select and click the option button to only display Event, System, Operation, Network or POS.
(16) Auto Scan	Start/Stop video screen cycle switch
(17) Full screen	Use the entire area of the screen to only display the video. To return, Right click the mouse or press ESC on the keyboard.
(18) Alarm	Alert and display warning info. Only Administrator-level can reset and turn on, off and trigger the Sensor and Relay by right-clicking the item in the Sensor and Relay list.

8.3.1 To Setup Remote Console Setting

Click **OK** to exit and save the setting and **Cancel** to exit without saving the setting.

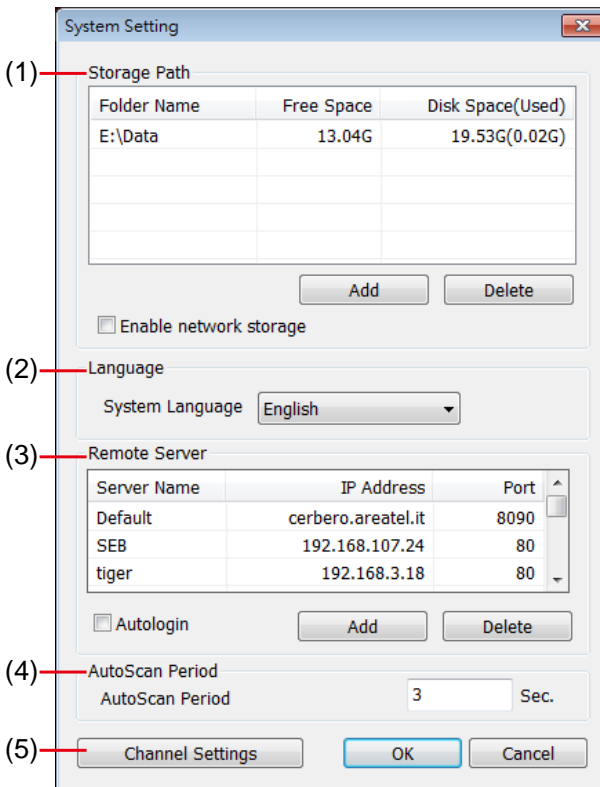

(1) Storage Path

Set the directory on where to save the data. When there is not enough free space to record one hour data, the system automatically replaces the oldest data. In case you have more than one storage path, the system automatically saves the data to the next storage path.

By default the data is stored in C:\RemoteData, to insert another storage path, click **Add**. To remove

the selected path, click **Delete**.

Select the **Enable network storage** check box to send the recorded video in network-attached storage. To add network storage, the Internet storage drive/folder must be mapped as Network Drive in DVR server. Enable network storage first, and then, click Add. In **Browse For Folder** windows, select drive C and right click mouse button, select **Map Network Drive** option.

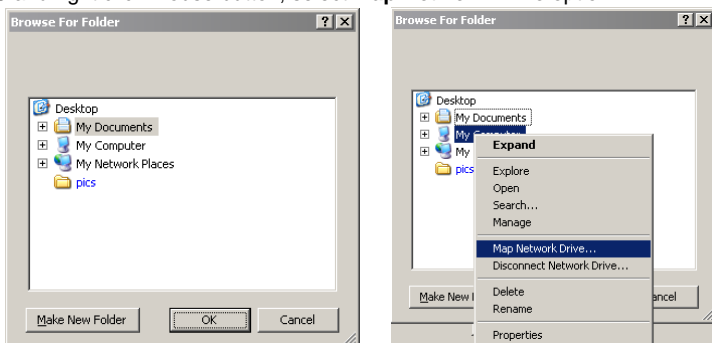

In the **Map Network Drive** windows, select the **Drive** and fill in the network drive direction in **Folder** column if you know. Or click **Browse** to find the folder direction. Click **Finish** to complete the network drive mapping. After the network drive has been added, user needs to create a folder for network storage. In **Browse For Folder** windows, select the network drive and right click mouse button to add a new folder. And then, click **OK**. User should see a new storage folder display in Storage path list.

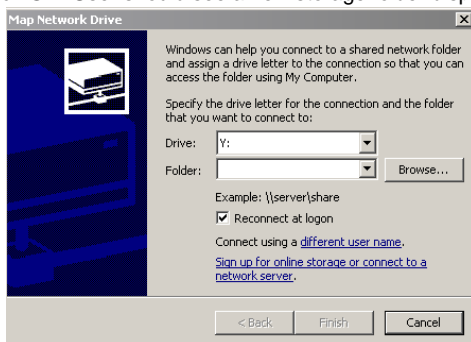

(2) Language

Customize the system to display the tool tips and dialogs based on the selected language. By default the language is in English.

(3) Remote Server

Click **Add** to add DVR server besides the default DVR server. User can easily switch to another DVR server connection by click the DVR server list in table.

- ✓ **Autologin:** The remote console will login to the last connected DVR server automatically when next time execute remote console program.

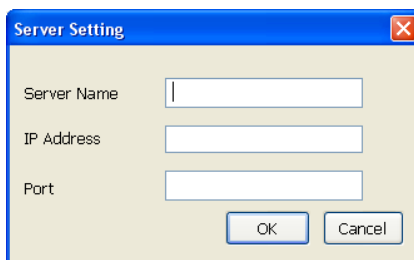

(4) Autoscan Period

Set the time gap period for channel display auto switch cycle.

(5) Channel Settings

The numbers from 01 to 16 represent the camera ID. In Transmitting Channels section, enable the camera number to receive the camera signal from the server. In Visible Channels section, enable the camera number to view the camera signal on Remote Console screen. To select all the cameras, enable the **ALL** check box.

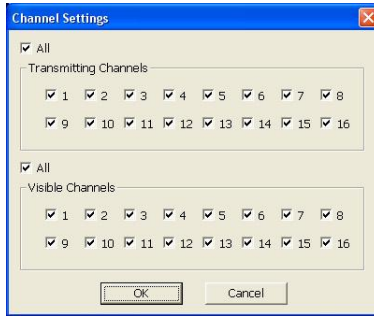

8.4 Familiarizing the Buttons in PTZ Camera Controller

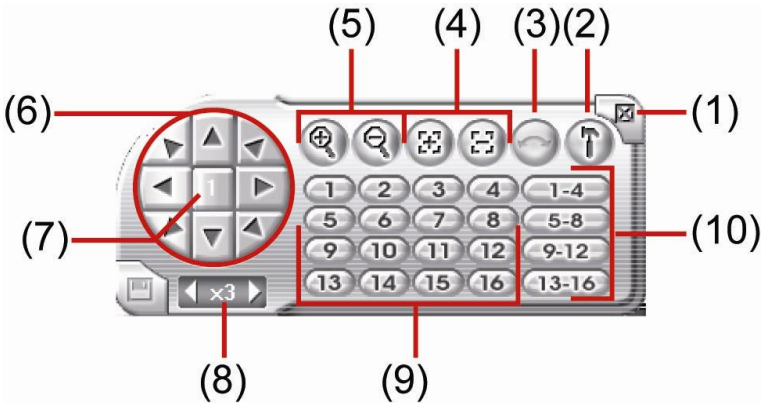

Name	Function
(1) Close	Exit PTZ camera controller.
(2) Setup	Configure PTZ cameras.(also see Chapter 4.13)
(3) AutoPan	Operate the PTZ cameras automatically based on the selected camera group preset position number.
(4) Focus +/-	Adjust the focus manually to produce clear image.
(5) Zoom +/-	Zoom in and out the image.
(6) Direction buttons	Adjust and position the focal point of the PTZ camera.
(7) Camera ID pane	Display the PTZ camera number that is being operated.
(8) Camera lens speed controller	Adjust the moving speed of the PTZ camera lens.
(9) Camera preset position number	Move the PTZ camera to the preset point.
(10) Group AutoPan	Select to automatically operate PTZ camera in group.

8.5 Using the Remote Playback

To use this feature, first you need to select the source of the file. In the **Select Playback Mode** dialog box, choose **Local Playback** to open the file that is recorded in the Remote Console, and **Remote Playback** to open the file that is recorded in the NV DVR server. When you choose Remote Playback, select **RealTime Playback** if your internet bandwidth is fast and big enough, otherwise choose **Download and Playback**.

Click **OK** to proceed and **Cancel** to void this operation.



In the Video Playback Date/Time Selection, the number from 00 to 23 represent the time in 24-hour clock. The numbers from 01 to 16 represent the camera number. To switch to channel group click **Channel 01-16** and **Channel 17-32** button.

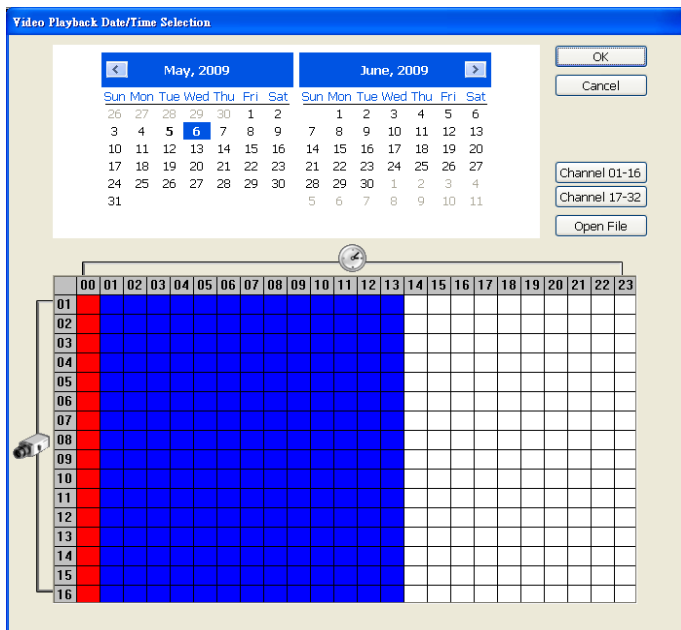

To Make a Selection:

1. Select the date in the calendar. Use ◀ and ▶ buttons to shift the calendar to the left or right.
2. In the table below, click on the blue block to select and open the recorded file. The blue block turns red when it is selected. The block that appears in white doesn't have data. You can only select one block when you choose Download and Playback.
3. Click **OK** to proceed and **Cancel** to void this operation.
4. If you select Download Playback and after making the selection, the system divides the selected hour into 16 video thumbnails. In the Time Selection screen, click on the video thumbnail you want to download and open (see also [Chapter 8.5.2](#)).



8.5.1 Familiarizing the Local Playback Buttons

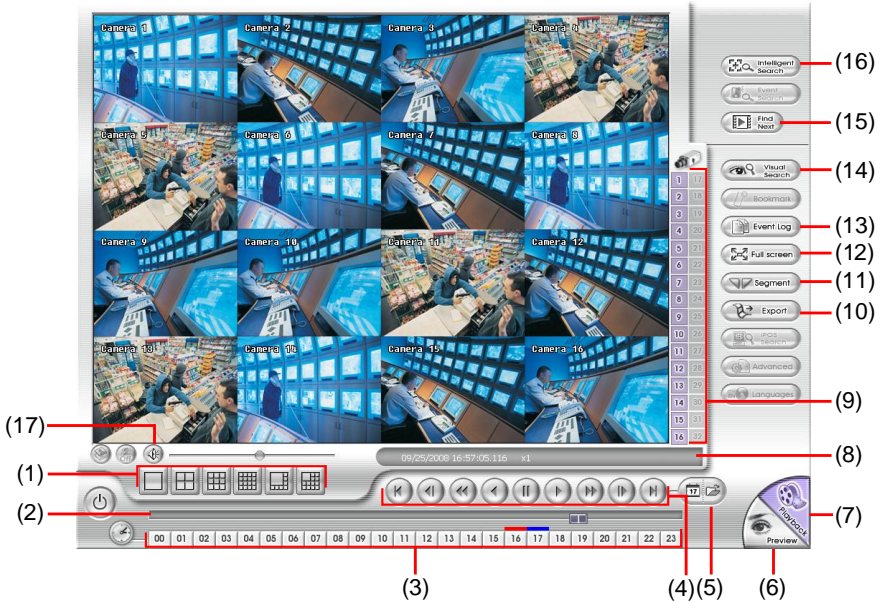

Name	Function
(1) Split Screen Mode	Select from 6 different split screen types to playback the recorded video file of all the camera, or one camera over the other or alongside on a single screen.
i	<ul style="list-style-type: none"> - If there are only 4 cameras, you won't be able to switch to 9, 16, and 13 split screen mode. - To zoom in an area on the screen, Right click and Drag a square on the area you want to enlarge.
(2) Progress bar	Show the progress of the file being played. You may move the bar to seek at any location of the track.
(3) Hour Buttons	Select and click to playback the recorded video file on the specific time frame.
i	The Hour buttons represent the time in 24-hour clock. The blue bar on top of the hour button indicates that there is a recorded video file on that period of time. While the red bar indicates that you are currently viewing the recorded video file.
(4) Playback Control Buttons	<p>Begin: Move at the beginning of the recorded video file.</p> <p>Previous: Go back to the previous frame.</p> <p>Slower: Play the recorded video file at the speed of 1/2x, 1/4x, or 1/8x.</p> <p>Rewind: Wind back the recorded video file.</p> <p>Pause: Briefly stop playing the recorded video file.</p> <p>Play: Play the recorded video file.</p> <p>Faster: Play the recorded video file at the speed of 2x, 4x, or 8x, 16x or 32x.</p> <p>Next: Go to the next frame.</p> <p>End: Go to the end of the recorded video file.</p>

Name**Function**

(5) Archive

Select the date on the calendar and the time from 00 to 23 to where to start playing the recorded video file.

- Also, user can open the recorded file from certain location by click **OPEN FILE** button
- Click **Channel 01~ 16** and **Channel 17 ~ 32** button to switch to different channel group of playback calendar.
- Mark **Day Light Saving**, the playback calendar will show the available playback records during day light saving period.

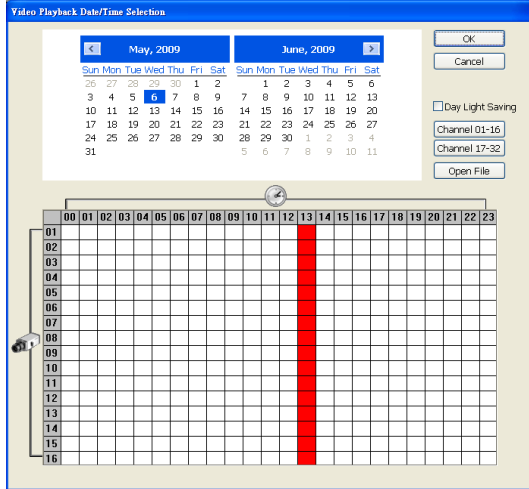

The numbers from 00 to 23 represent the time in 24-hour clock. The numbers from 01 to 16 represent the camera ID. The blue colored column indicates that there is a recorded video file on that period of time. While the red colored column indicates on where to start playing the recorded video file.

(6) Preview

Switch to Preview/Advanced mode.

(7) Playback

Switch to Playback mode. This allows you to view the recorded video file.

(8) Status bar

Display the recorded date, time and play speed.

(9) Camera ID

Show the number of cameras that are being viewed. When you are in single screen mode, click the camera ID number to switch and view other camera.

(10) Export

Export includes Snapshot, Print, and Output Video Clip function.

- **Snapshot:** Capture and save the screen shot either in *.jpg or *.bmp format.
- **Print:** Print the screen shot.
- **Output Video Clip:** Save the segmented file in *.mpg, *.avi, or *.dvr format (see also [Chapter 4.8](#)).

(11) Segment

Keep a portion of the recorded video (see also [Chapter 4.8](#)).

Name	Function
------	----------

(12) Full screen	View in Playback-compact mode. To return, press the right button of the mouse or ESC on the keyboard or click the arrow icon.
------------------	--



When you switch to full screen in multiple-screen mode, **Left** click to toggle to only display one of the video in the multiple-screen mode or all.



When there are dual monitors with 32 channels, the full screen mode will split into 16 channels on each monitor.

(13) Event log	Show the record of activities that take place in the system. To filter the records, select and click the option button to only display Event, System, Operation, Network or POS.
----------------	--

(14) Visual Search	Search from a specific camera by Date, Hour, Minute, 10 Seconds and Second. (See also Chapter 4.10)
--------------------	--



The Visual and Intelligent search only available when the remote site is recording and playback from remote local hard disk.

(15) Find Next	Search for the next event or changes in the motion detector frame. You can use this when you are using Intelligent Search or Event Search function.
----------------	---

(16) Intelligent Search	Search the changes in the motion detector frame (See also Chapter 4.12).
-------------------------	---

(17) Audio	Enable/disable audio play. To adjust audio volume, drag and move the audio volume bar beside the audio button.
------------	--

8.5.2 Familiarizing the RealTime Playback Buttons

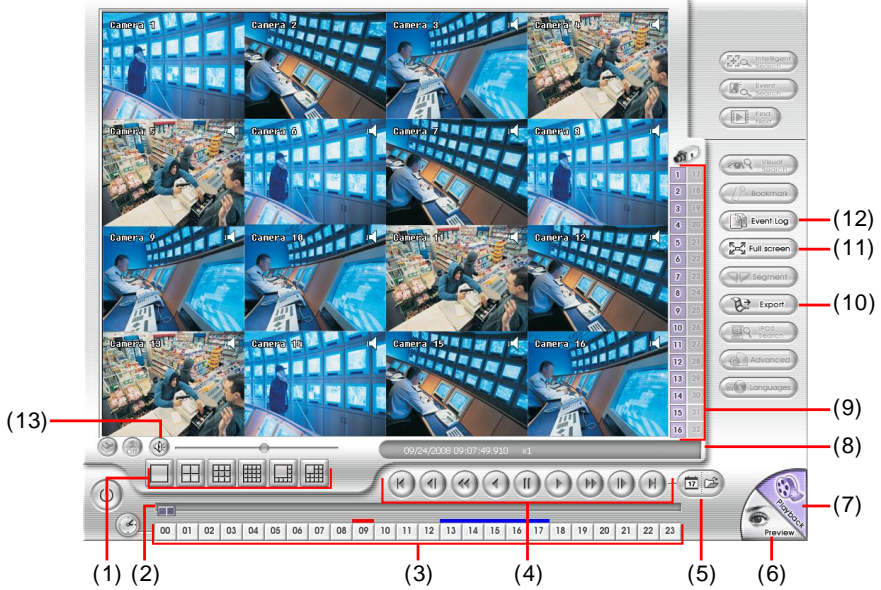

Name	Function
(1) Split Screen Mode	Select from 6 different split screen type to playback the recorded video file of all the camera, or one camera.
i	<ul style="list-style-type: none"> - If there are only 4 cameras, you won't be able to switch to 9, 16, and 13 split screen mode. - To zoom in an area on the screen, Right click and Drag a square on the area you want to enlarge.
(2) Progress bar	Show the progress of the file being played. You may move the bar to seek at any location of the track.
(3) Hour Buttons	Select and click to playback the recorded video file on the specific time frame.
i	The Hour buttons represent the time in 24-hour clock. The blue bar on top of the hour button indicates that there is a recorded video file on that period of time. While the red bar indicates that you are currently viewing the recorded video file.
(4) Playback Control Buttons	<p>Begin: Move at the beginning of the recorded video file.</p> <p>Previous: Go back to the previous frame.</p> <p>Slower: Play the recorded video file at the speed of 1/2x, 1/4x, or 1/8x.</p> <p>Rewind: Wind back the recorded video file.</p> <p>Pause: Briefly stop playing the recorded video file.</p> <p>Play: Play the recorded video file.</p> <p>Faster: Play the recorded video file at the speed of 2x, 4x, or 8x, 16x or 32x.</p> <p>Next: Go to the next frame.</p> <p>End: Go to the end of the recorded video file.</p>

Name	Function
------	----------

- | | |
|-------------|---|
| (5) Archive | <ul style="list-style-type: none"> - Select the date on the calendar and the time from 00 to 23 to where to start playing the recorded video file. - Also, user can open the recorded file from certain location by click OPEN FILE button - Click Channel 01~ 16 and Channel 17 ~ 32 button to switch to different channel group of playback calendar. - Mark Day Light Saving, the playback calendar will show the available playback records during day light saving period. |
|-------------|---|

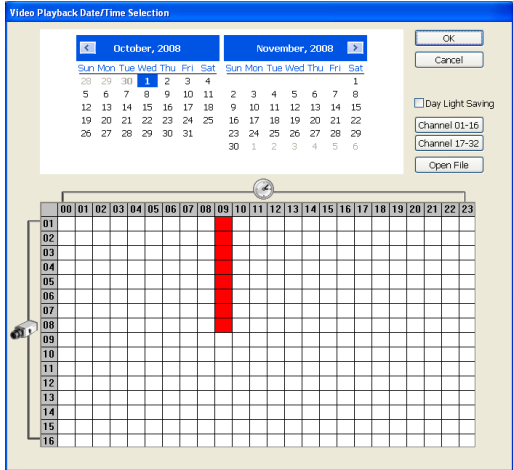

The numbers from 00 to 23 represent the time in 24-hour clock. The numbers from 01 to 16 represent the camera ID. The blue colored column indicates that there is a recorded video file on that period of time. While the red colored column indicates on where to start playing the recorded video file.

(6) Preview	Switch to Preview/Advanced mode.
(7) Playback	Switch to Playback mode. This allows you to view the recorded video file.
(8) Status bar	Display the recorded date, time and play speed.
(9) Camera ID	Show the number of cameras that are being viewed. When you are in single screen mode, click the camera ID number to switch and view other camera.
(10) Export	Export includes Snapshot, Print, Output Video Clip, and Backup function. <ul style="list-style-type: none"> ■ Snapshot: Capture and save the screen shot either in *.jpg or *.bmp format. ■ Print: Print the screen shot. ■ Output Video Clip: Save the segmented file in *.mpg, *.avi, or *.dvr format (see also Chapter 4.8).
(11) Full screen	View in Playback-compact mode. To return, press the right button of the mouse or ESC on the keyboard. When you switch to full screen in multiple-screen mode, Left click to toggle to only display one of the video in the multiple-screen mode or all.
(12) Event log	Show the record of activities that take place in the system. To filter the records, select and click the option button to only display Event, System, Operation, Network or POS.

Name	Function
(13) Audio	Enable/disable audio play. To adjust audio volume, drag and move the audio volume bar beside the audio button.

8.5.3 Familiarizing the Download and Playback Buttons



Name	Function
(1) Exit	To exit application
(2) Progress bar	Show the progress of the file being played. You may move the bar to seek at any location of the track.
(3) Hour Buttons	Select and click to playback the recorded video file on the specific time frame.
<p>i The Hour buttons represent the time in 24-hour clock. The blue bar on top of the hour button indicates that there is a recorded video file on that period of time. While the red bar indicates that you are currently viewing the recorded video file.</p>	
(4) Playback Control Buttons	<p>Begin: Move at the beginning of the recorded video file.</p> <p>Previous: Go back to the previous frame.</p> <p>Slower: Play the recorded video file at the speed of 1/2x, 1/4x, or 1/8x.</p> <p>Rewind: Wind back the recorded video file.</p> <p>Pause: Briefly stop playing the recorded video file.</p> <p>Play: Play the recorded video file.</p> <p>Faster: Play the recorded video file at the speed of 2x, 4x, or 8x, 16x or 32x.</p> <p>Next: Go to the next frame.</p> <p>End: Go to the end of the recorded video file.</p>
(5) Status bar	Display the recorded date, time and play speed.
(6) Language	To switch the application tips' display language

Name	Function
(7) Export	Export includes Snapshot, Print, and Output Video Clip function. <ul style="list-style-type: none"> ■ Snapshot: Capture and save the screen shot either in *.jpg or *.bmp format. ■ Print: Print the screen shot. ■ Output Video Clip: Save the segmented file in *.mpg, *.avi, or *.dvr format (see also Chapter 4.8).
(8) Segment	Keep a portion of the recorded video (see also Chapter 4.8).
(9) Full screen	View in Playback-compact mode. To return, press the right button of the mouse or ESC on the keyboard. When you switch to full screen in multiple-screen mode, Left click to toggle to only display one of the video in the multiple-screen mode or all.
(10) Event log	Show the record of activities that take place in the system. To filter the records, select and click the option button to only display Event, System, Operation, Network or POS.
(11) Visual Search	Search from a specific camera by Date, Hour, Minute, 10 Seconds and Second. (See also Chapter 4.10)
(12) Find Next	Search for the next event or changes in the motion detector frame. You can use this when you are using Intelligent Search or Event Search function.
(13) Event Search	Search from the recorded activities that take place in the system (i.e., Sensor, Motion, Video Loss, POS). (See also Chapter 4.11)
(14) Intelligent Search	Search the changes in the motion detector frame (See also Chapter 4.12).
(15) Audio	Enable/disable audio play. To adjust audio volume, drag and move the audio volume bar beside the audio button.

8.6 Using HandyViewer to Access NV DVR server

Users can use a mobile phone to access the NV DVR through Internet. Make sure your mobile phone support IE browser and is connected to the internet. To access the NV DVR server, open IE browser and enter **http://DVR IP/mobile**. You can see the latest screen shot. Click << >> to change the channel or camera and **Refresh** to reload new screen shot.

8.7 Using PDAViewer to Access NV DVR Server

Users can also use a PDA to access the NV DVR through Internet. Make sure your PDA support IE browser and is connected to the internet. To use this feature, you need to install the PDA Viewer software either thru ActiveSync connection or download it from the internet. Please check if your PDA meets the 2 requirements below.

**OS: Microsoft Pocket PC 4.20.0, Windows Mobile6 Professional
CE OS 5.2.1437, MS Windows CE 4.0, PocketPC 2002/2003,
Mobile 5 PDA version**

CPU: ARM architecture

8.7.1 To install PDAViewer thru ActiveSync

1. Connect your PDA to your PC. Place the CD into the CD-ROM drive then click Install PDAViewer. And follow the on screen instructions.



2. Click **Next** to continue.

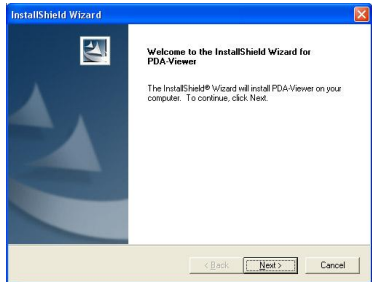

3. Read the license agreement and click **Yes** to accept all the terms. The system will then automatically install the application.



- 4. When you are prompted, click **Yes** to install the application using the default directory.

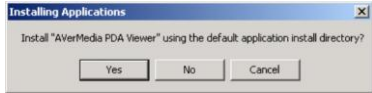

- 5. When done, click **OK**.

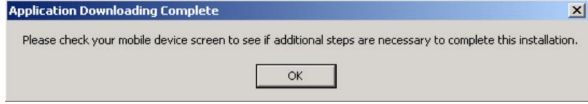

8.7.2 To install PDAViewer from the Internet

Make sure you are connected to the internet.

- 1. Open the web browser and enter the server IP. Then click the hyperlink **Download PDAViewer**.



- 2. When the Download dialog box appears, enable **Open file after download** and click **Yes**.



After the installation, the PDAViewer icon will appear in the Programs list.



8.7.3 To Use the PDAViewer

1. Run the **PDAViewer** in the Programs.
2. Familiarizing the PDAViewer buttons.



PDAViewer only support audio for analog camera.

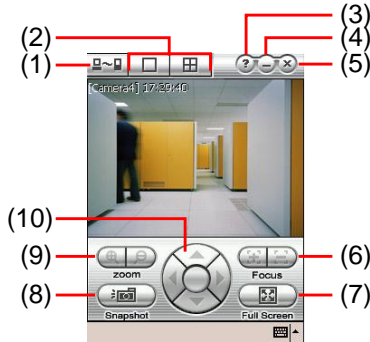

Name	Function
------	----------

- | | |
|-------------|---|
| (1) Connect | Hook up to the DVR server. Make sure you are connected to internet. When the iView screen appears, click Add to add DVR server. |
|-------------|---|

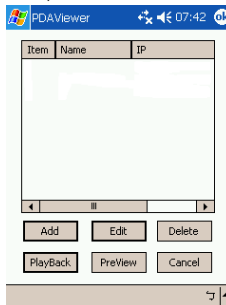

Enter the server IP, port, user ID, password and select the connection type. Then, click **OK**.

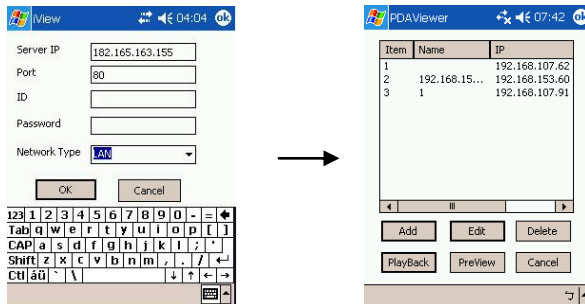

User can playback the recorded video from remote DVR server in PDAViewer.(see [Chapter 8.7.4](#))

- | | |
|------------------|--|
| (2) Split Screen | Select between 2 screen display types. It also allows you to switch and view |
|------------------|--|

Name	Function
Mode	different camera number or channels.
(3) About	Display the PDAViewer software version.
(4) Minimize	Reduce the size to taskbar.
(5) Exit	Close the PDAViewer.
(6) Focus	Adjust the focus of PTZ camera to produce clear image.
(7) Full Screen	Use the entire screen to only display the video.
(8) Snapshot	Capture and save the screen shot in *.bmp format.
(9) Zoom	Zoom in and out the PTZ camera image.
(10) Direction buttons	Adjust and position the focal point of the PTZ camera.

- To change the video quality, enable/disable audio, and select to display different camera, tap on the video screen longer the pop up menu will appear.



8.7.4 To Playback in PDAViewer

- Run the **PDAViewer** in the Programs.
- Hook up to the NV DVR server.
- Click **Connect** icon and select the DVR server
- Click **Playback** to enter playback option screen
- Select the **camera, data, and time**
- Click **Playback** to start playing the recorded video

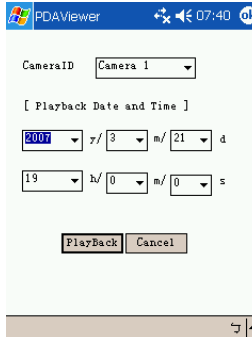

- While playback, user can view and change status of I/O devices
- On the playback screen, tap on video screen longer the pop up menu will appear

9. Select the **Remote IO**



10. The sensor and relay devices will list as below:

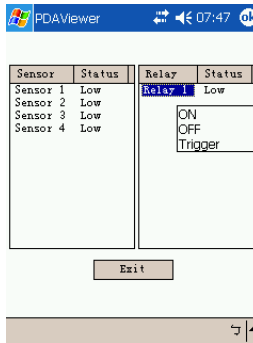

11. User can change the relay status. Select the relay and tap on video screen longer the pop up menu will appear, and then, select the status (ON, OFF, Tigger)

8.8 Using JavaViewer to Access NV DVR Server

Using the mobile phone within Symbian Smart Phone OS to access the NV DVR through Internet. Make sure your mobile phone supports Symbian Smart Phone OS and can be connected to the internet. To use this feature, you need to install the Java Viewer program that it can be downloading it from the DVR server through the internet.

8.8.1 To install JavaViewer from the DVR Server

1. Open the web browser and enter the DVR server IP (<http://DVR server IP: port/Java-Viewer.html>). Then click **Connect**.
2. When the Download screen appears, select **Java-Viewer.jad** and download it to your mobile phone.
3. After the installation, the JavaViewer will be in your mobile phone system. To find the JavaViewer program where is located, please refer to your mobile phone user's manual.

8.8.2 To Use the JavaViewer

1. Run the JavaViewer program.
2. Enter the DVR IP address, port number, user ID, and password. Please refer to your DVR server setting for that information.
3. And then, select the Connect to connect to DVR server.
4. Click **Yes** to accept the data from DVR server.



5. When connection is success, you will see the camera video on the screen.



6. To switch to different camera view, select menu and select the channel.



7. The JavaViewer support PTZ control function, you can refer to **Help** file for detail function control key. Select **menu** and go the way down to select the **Help** file.



8.9 Using iPhone to Access Remote DVR Server



Before using iPhone to access remote DVR server, user needs to enable **Enable HandyViewer** this function in **Network Setting** of DVR server site.

Using the iPhone can connect to remote DVR server through the Internet to view the live image.

8.9.1 Download the iViewer

To use this feature, it is required to download the iViewer application to your iPhone. There are 2 ways to download the iViewer to your iPhone. User can chose one of way to download.

I. Download through the PC

10. Connect your iPhone to the PC.

11. In iTunes UI, enter keyword “**AVerDiGi**” to search.

12. And then, the AVerDiGi iViewer will be found and display on iTunes UI.

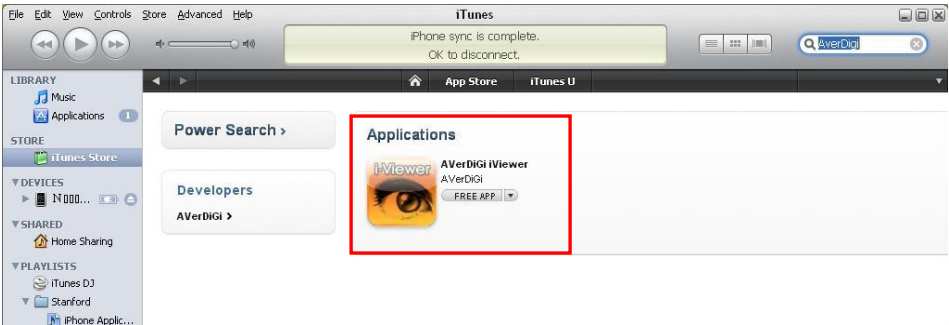

13. Click AVerDiGi iViewer and click **Free App** to download the application. And then, enter the **ID** and **Password** to download.

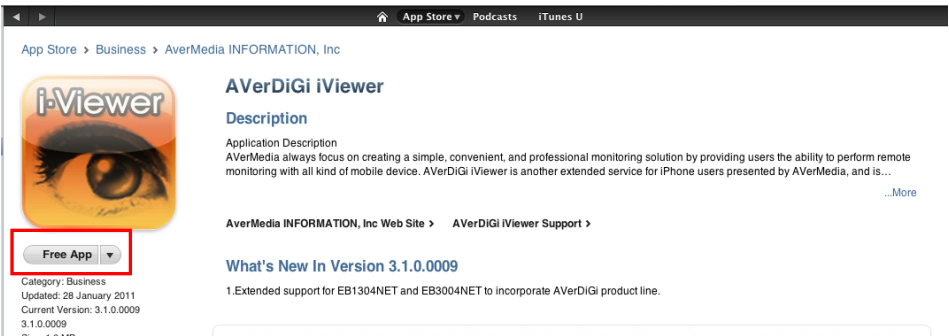

14. After download the iViewer, click **Application** and mark the **AVerDiGi iViewer**.

15. Click **Apply** button. The iViewer will load into your iPhone.



16. To use iVewer, select the AVerDiGi iViewer icon () on your iPhone. How to use iViewer, please refer to [Chapter 8.9.2](#).

II. Using iPhone to Download

1. Please make sure your iPhone connect to the Internet.
2. Select **App Store** from iPhone main screen.
3. Select **Search** and enter the keyword “**AVerDiGi**” to search.
4. In search result list, select the **AVerDiGi iViewer**. User will see a brief introduction of the AVerDiGi iViewer. Select the **Free** button, the button will change to the **Install** button. Select **Install** to download the application.
5. And then, enter ID and Password to start download processing.
6. After download completed, go back to iPhone main screen and user should see **AVerDiGi iViewer** icon () on the menu list. Select it to run the application. How to use iViewer, please refer to [Chapter 8.9.2](#).

8.9.2 Using the iViewer

1. After iViewer has been downloaded to your iPhone, select the iViewer to execute.
2. In login screen, enter the following information to make a connection with the remote DVR server.

After entered all necessary information, click **Login**.

- **Host:** IP address of the remote DVR server.
- **Port:** The connection port of the remote DVR server.
- **ID:** The user account to login the remote DVR server.
- **Password:** The password for login authentication.

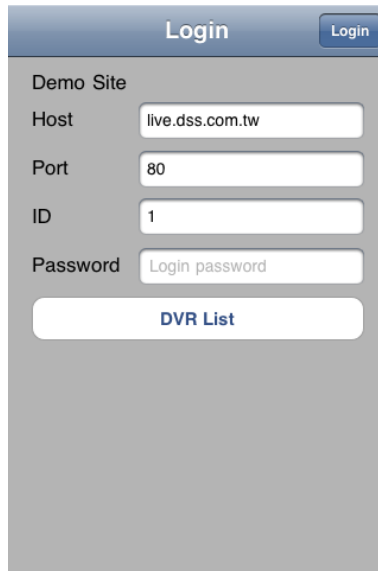



The screenshot shows a mobile application interface for logging into a remote DVR server. The interface is titled "Login" and includes a "Demo Site" label. It features four input fields for "Host", "Port", "ID", and "Password", each with a corresponding label. The "Host" field contains "live.dss.com.tw", the "Port" field contains "80", the "ID" field contains "1", and the "Password" field contains "Login password". A "Login" button is located in the top right corner, and a "DVR List" button is positioned below the password field.

3. After login, user should see the live video on iPhone screen.



The horizontal screen display has supported.





4. Click  or  button can switch the channel display between 1 and 4-split channels screen.



4-split screen



1 channel screen

5. In 4-split screen mode, click the channel group can switch to view different group channel.
 6. In single screen mode, click channel button to view the channel.
 7. Click < or > to go back last page or next page of channels.
 8. Click  icon can hide the channel number buttons. Click  icon again to display the channel number buttons.



9. Select the PTZ camera channel and click  button to switch to PTZ operation mode (see [Using PTZ Function](#)).



PTZ mode

10. To logout iViewer or disconnect with the current DVR connection, click **Exit** and return to the iViewer login screen. In Login screen, user can connect other DVR server.
11. To close the iViewer application, press the button that is located at bottom of your iPhone.

8.9.3 To Add DVR Server into DVR List

User can add frequently connect DVR server into DVR list.

1. In login screen, select **DVR List**.

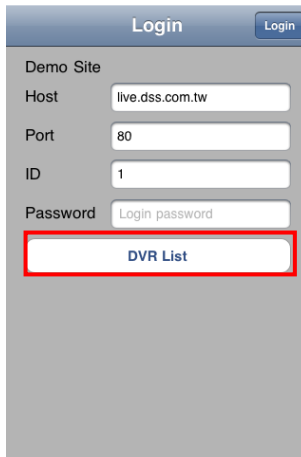

2. In DVR List screen, select  button to add DVR server.

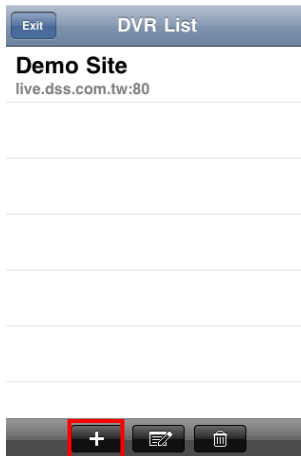



3. In Add DVR screen, enter the following data:
 - **Name:** Give a name to the DVR server for recognizing.
 - **Host:** IP address of the remote DVR server.
 - **Port:** Enter the port number of WebViewer port that user has setup on remote DVR server.
[Note] WebViewer port might also be called "Video port" on some DVR servers.
 - **ID:** The user account to login the remote DVR server.
 - **Password:** The password for login authentication.

4. And then, select **Save** button to complete the adding. User should see the DVR in DVR List.
5. To add another DVR server, please repeat above step 2~4.
6. To edit the DVR server, select  (edit) button first, and then, select the DVR server from DVR List. After edit, select **Save** to save the changes.

7. To delete the DVR server, select  (delete) button, and then, select the DVR server that user wants to delete and select **OK** to confirm.



8.9.4 Using PTZ Function

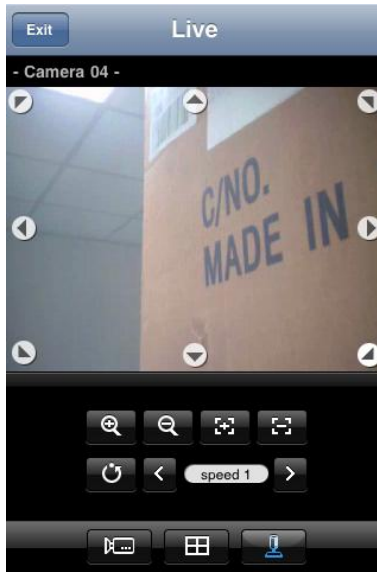

Select the PTZ camera channel and click  button to switch to PTZ operation mode. To close PTZ function mode, click  button again.



PTZ operation mode supports in horizontal screen display.



Button	Description
	Click direction button to move lens of PTZ camera. The directions are depends on the PTZ camera has supported.
	Zoom in and out the image.
	Adjust the focus manually to produce clear image.

Button	Description
	Move the PTZ camera to the preset point. Select the preset point position and click GO button. To leave the preset point position selection, click Exit .
	
	Adjust the moving speed of PTZ camera.

8.10 Using BlackBerry Phone to Access DVR server

Using the BlackBerry phone can connect to remote DVR server through the Internet to view the live video.

Supported Model	Blackberry 9500 storm
OS	blackberry 4.7 (Please refer to blackberry website for detail OS version)

Note

All the illustrations are schematic illustration for user's reference only.

To use this feature, it is required to download the iBBViewer application to your BlackBerry phone. There are 2 ways for downloading iBBViewer. Please follow the below description to download the iBBViewer application.

8.10.1 Download through the BlackBerry Desktop Manager

1. Connect the BlackBerry phone to the PC.
2. Download the **iBBViewer** files (iBBViewr.alx and iBBViewer.cod) from ftp site (<http://www.avermedia.com/averdigi/Support/Download.aspx>) and save in same folder on the hard disk of the PC that is connected with BlackBerry phone.
3. Activating **BlackBerry Desktop Manager** application on your PC.
4. In BlackBerry Desktop Manager UI, select **Application Loader**.

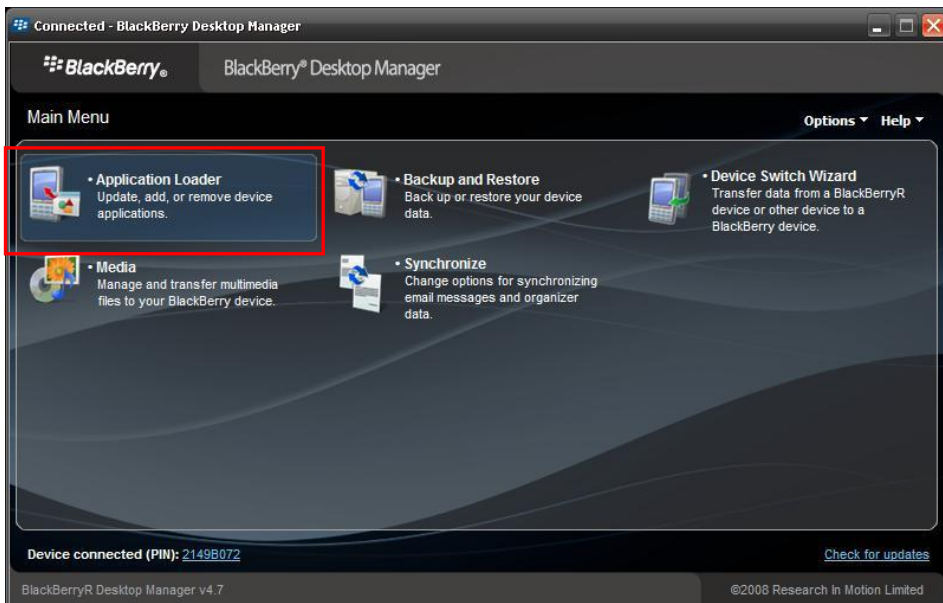

5. And then, click **Start** button of **Add/Remove Applications** option.

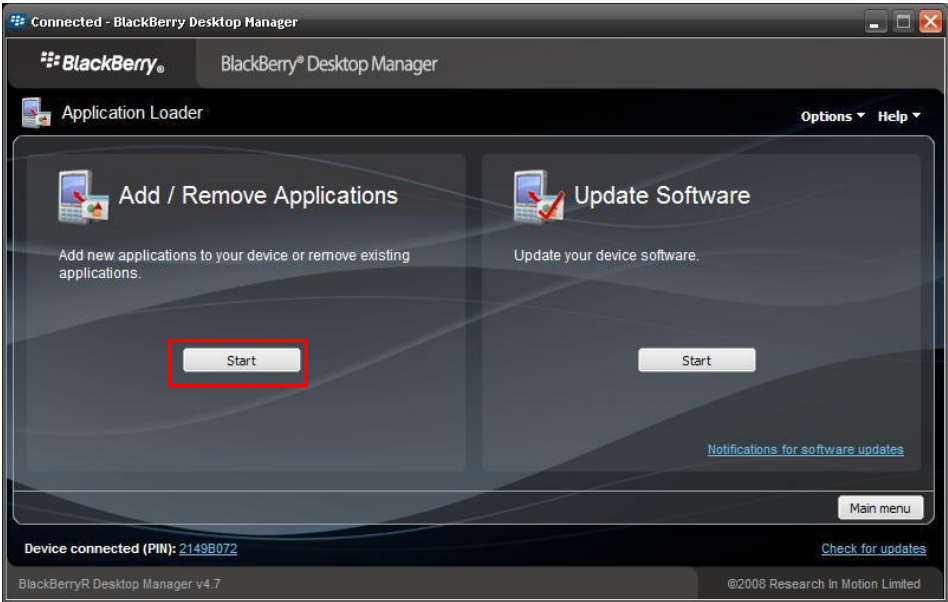

6. In Device application selection window, click **Browse** button to locate the iBBViewer files that you have download from the ftp site and select the **iBBViewer.alx**. After located the files, user will see the iBBViewer application list out. Mark the check box and click **Next**. And then, in next screen, click **Finish** to install the iBBViewer application.

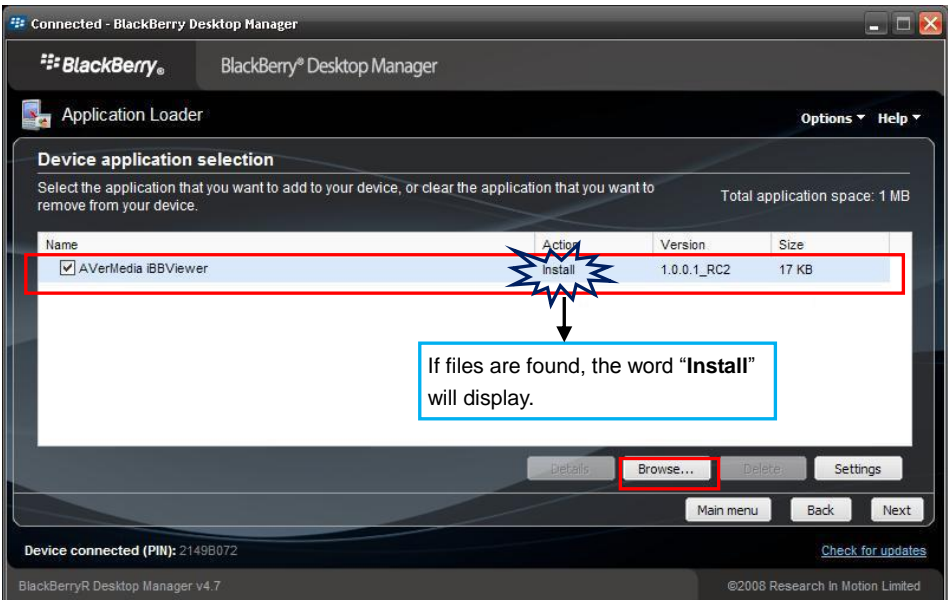

7. After installation completed, the iBBViewer application is installed on your BlackBerry phone and is ready for use.



8.10.2 Using BlackBerry Phone to Download iBBViewer

1. Please make sure your BlackBerry phone connects to the Internet.
2. In main menu, open the **Browser**.



3. Enter the **URL** (<http://DVR's ip address/iBBViewer.cod>) to download iBBViewer application.

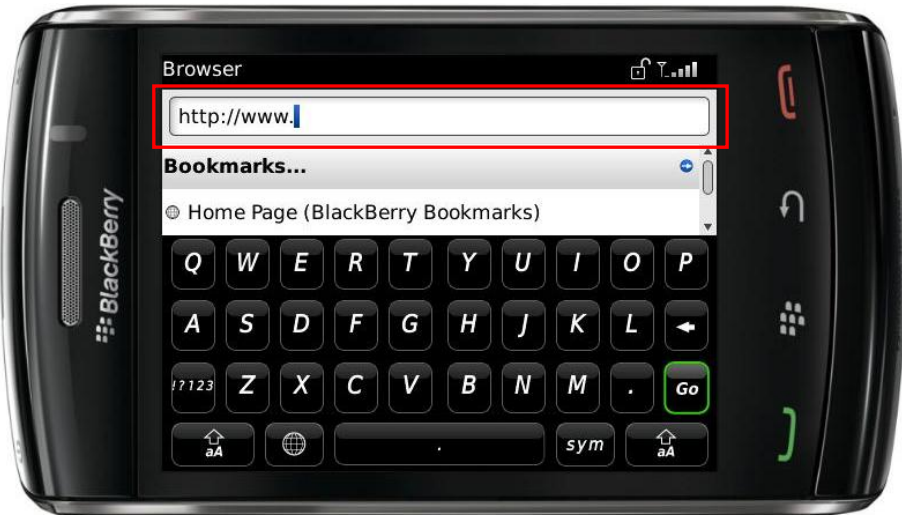

4. Click **Download** button to start download process.



5. When installation completed, click **OK** to finish. The BBiViewer is installed on your BlackBerry phone and is ready for use.



8.10.3 Using the iBBViewer

1. After iBBViewer has been installed to your BlackBerry phone, select the iBBViewer to execute.



2. Press menu button of BlackBerry phone to call out menu. Select **Connect** to make a connection to the DVR server that user wants to monitor.



Tip

If BlackBerry phone is unable to connect with DVR server, please select **Option > Advanced Option > TCP/IP** in main menu of BlackBerry phone. In TCP/IP, please check the APN setting and make sure APN settings are correct.

3. In connection screen, enter **DVR IP**, **Port**, **User ID** and **Password** for login to the DVR server.
- **DVR IP:** IP address of the remote DVR server.
 - **Port:** The connection port of the remote DVR server. The default value is 5550.
 - **User ID:** The user account to login the remote DVR server.
 - **Password:** The password for login authentication.

Network Setting
DVR IP
Port 5550
User ID
Password

4. When connection is successful, the screen will display the video from the DVR server. On top of screen will show the camera channel is currently display.
5. Press **menu** button of BlackBerry phone to call out menu. User can select different channel to view. If the camera channel is a PTZ camera, user can use keyboard (**2** is up, **8** is down, **4** is left, **6** is right) of BlackBerry phone to control camera.

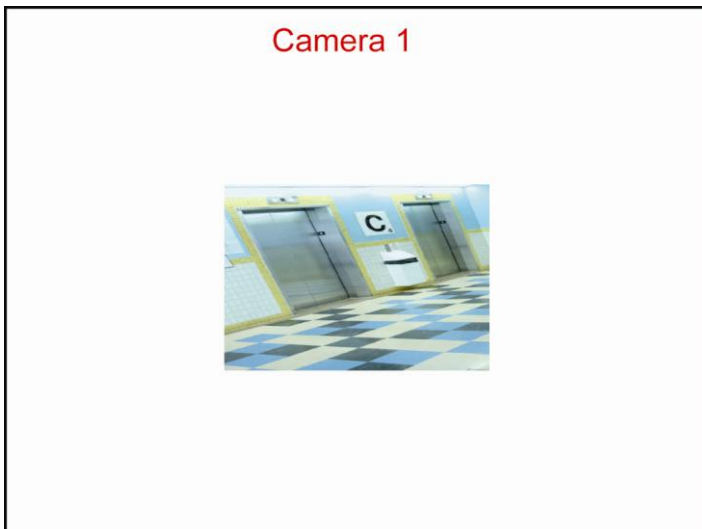

6. To disconnect current connection with DVR server, click Stop and return to the iBBViewer screen.

Chapter 9 Image Verification

ImageVerification is a watermark-checking program to identify the authenticity of a saved image (e.g. by snapshot). This program can only verify uncompressed bmp image files.

9.1 To Run the ImageVerification program

1. Click **Start>Programs>DVR>ImageVerification**.
2. In the ImageVerification screen, click **Load Source Image** and locate the image source.
3. Click **Verify Image** to begin the process.
4. Check the result in the Processed Image screen. If the picture is unmodified, the image in the Source Image and Processed Image screen would be exactly the same. If the picture is being modified, a warning dialog box would prompt you and the modified area is highlighted.

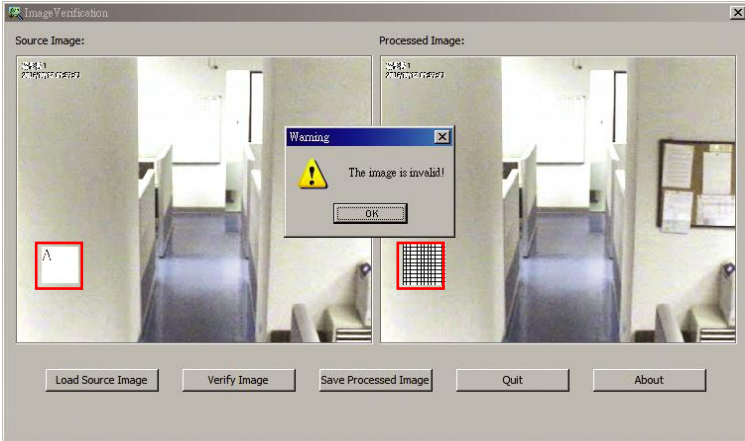

Chapter 10 iEnhance

The bundled iEnhance is a video editing tool and can only be used with *.dvr video file. It allows you to adjust the video picture quality, segment and save the wanted portion of the video, zoom in and out the image, and print or save the screen shot. You can also save the setting and apply it on other files.

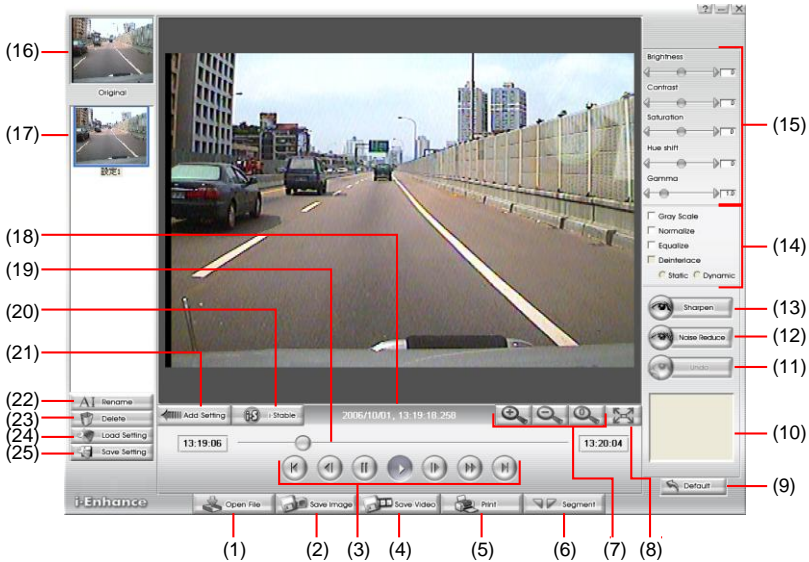

Name	Function
(1) Open File	Access *.dvr video file.
(2) Save Image	Capture and save the screen shot in *.bmp format.
(3) Playback Control Buttons	Begin: Move to the beginning of the video file. Previous: Go back to the previous frame. Pause: Briefly stop playing the video file. Play: Play the video file. Faster: Play the video file at faster speed Next: Go to the next frame. End: Go to the end of the video file.
(4) Save Video	Save the edited or segmented video in *.avi format.
(5) Print	Print the screen shot.
(6) Segment	Mark the beginning and the end of the wanted portion of the video. Two triangle marks will appear on the slider. To cancel video segmentation, click this button again.
(7) Zoom Buttons	Enlarge, reduce, and set the image back to normal size.
(8) Full Screen	Use the entire screen to only display the video.
(9) Default	Set the video back to original state and delete all the changes in the history box.
(10) History Box	List all the actions.
(11) Undo	Delete the last action.
(12) Noise Reduce	Adjust the softness and repair the damaged colours.

Name	Function
(13) Sharpness	Improve the overall image by enhancing edges. This gives the image more depth.
(14) Effects	<ul style="list-style-type: none"> • Gray Scale: convert the image into black and white (monochrome). • Normalize: adjust the brightness intensity. • Equalize: automatically adjust the images that are too dark. • De-interlace: smooth out the overlying frames. • Static: de-interlace for motionless scene. • Dynamic: de-interlace for moving scene.
(15) Picture Adjustment	Adjust the Brightness, Contrast, Saturation, Hue and Gamma.
(16) Original Screen	Display the original state of the image.
(17) Temporary Setting Block	Display the sample settings. Click the sample to apply the setting on the current video.
(18) Status Bar	Display the date, and time of the video.
(19) Progress Bar	Show the progress of the file being played. You may move the bar to seek at any location of the track.
(20) iStable	To reduce the jolt in the recorded video.(also see Chapter 10.1)
(21) Add Setting	Include the new setting to the temporary setting block.
(22) Rename	Change the name of the selected setting in the temporary setting block.
(23) Delete	Permanently remove the selected setting in the temporary setting block.
(24) Load Setting	Call the saved settings.
(25) Save Setting	Store the settings in the temporary setting block.

10.1 To Use iStable

The iStable function can reduce the jolt in the recorded video.

1. Click Open File button and select the recorded video.
2. And then, click iStable button.
3. iStable windows will show up.
4. Select the smoothness level – 1(Low), 2, 3, 4, and 5(High). The default value is 3.
5. Click Play button, and then i-Stable function will start to initial the recorded video.
6. When the initialize is done, user will see the original and stabilized recorded video play in two windows.

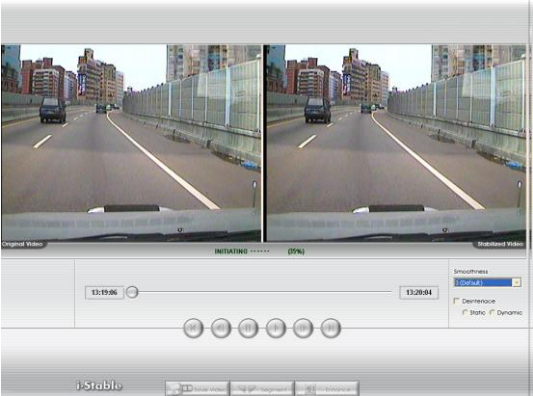

Chapter 11 Web Tools

The bundled Web Tools includes Dispatch Server and Remote Backup program. To install Web Tools, place the CD into the CD-ROM drive then click **Install Web Tools**.



11.1 Dispatch Server

Dispatch is designed to reduce the network traffic of the NV DVR server. Instead of connecting directly to the NV DVR server, the client can connect to the computer that is connected to the NV DVR server using the Dispatch program.

11.1.1 To Run Dispatch program

1. Make sure you are connected to the internet.
2. Click **Start>Programs>DVR>Tool>Dispatch**.
3. In the DVR Server section, enter the NV DVR server IP, port, user ID and password. You can also select to display the language you prefer.
4. **Auto connect when start**
Enable to automatically connect the dispatch server when start up
5. **3GPP Service**
Enable to allow user using 3GPP service to receive video stream from Dispatch server. The **Service Port** must same as RTSP port of 3GPP on DVR server.
6. In the **Dispatch Service** section, if you have installed more than one network card, select the Service IP number.
7. In the **Dynamic DNS Configuration** section, enter the DNS server Name and Password. The DNS server can be the remote storage server for sharing the DVR system loading.
8. Click **START** to connect.

11.2 Remote Setup



- Please make sure the **UAC** function has disabled before install Remote setup.
- To disable UAC, please go to User Account setting in Control Panel to turn User Account Control off. **If UAC doesn't disable, it might cause abnormal operation of DVR system.**

Remote Setup is a tool for configuring DVR server from remote site. To install Remote Setup application, insert the Installation CD into CD-ROM drive and click **Web Tools**. After installation, click  to start the Remote Setup application.

11.2.1 To Add DVR server

User need to add a DVR server and make connection in order to setup remote DVR server.

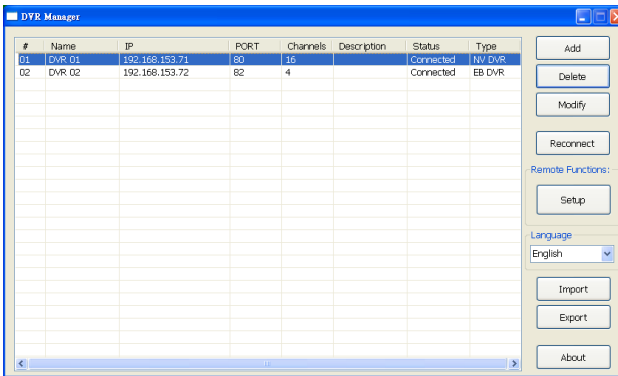

1. Click **Add**
2. In Edit DVR windows, fill in the following items:
 - **Name:** give a name for remote DVR server for easy managing
 - **IP:** fill in remote DVR server's IP address
 - **Port:** the port use to connect to remote DVR server. The port number is same the Webviewer port on the remote DVR server. The default is 80.
 - **User ID:** fill in the remote DVR server's login account
 - **Password:** fill in the remote DVR server's login password
 - **Description:** fill in a short description for the remote DVR server

3. Click **OK** to complete adding remote DVR server.

4. The added DVR server will be listed and auto connects to DVR server.
5. Once the connecting is success, user can start to configure DVR server.
6. When connection is lost, click **Reconnect** to connect again.
7. To modify or delete the added DVR server, select the DVR server from listing and click **Modify** to change the setting and click **Delete** to remove the DVR server.
8. User also can import the setting by clicking **Import** button. To save the setting to local hard disk, click **Export** button.

11.2.2 To Setup Remote DVR Server

Select the DVR server from listing and click **Setup** to configure remote DVR server.

System Setting

In the System Setting windows, click **Update** to accept the new settings, click **Exit** to exit without saving, and click **Default** to revert back to original factory setting.

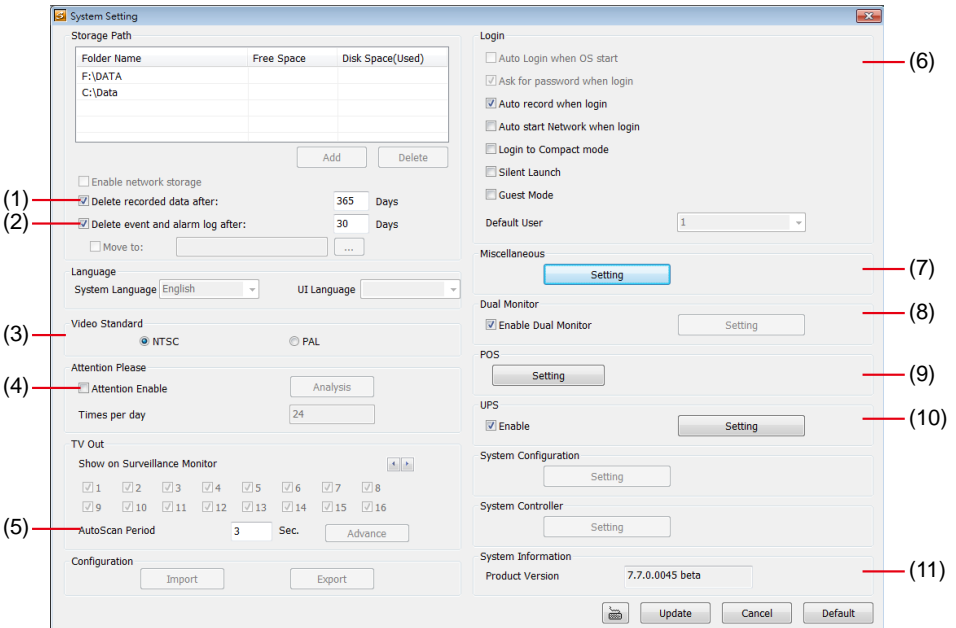

(1) Delete recorded data after

If you want the system to automatically erase the data after a certain days, enable the **Delete recorded data after** check box and enter the numbers of days in **Days** text box.

(2) Delete event and alarm log after

If you want the system to automatically erase the event and alarm log files after a certain days, enable the **Delete event and alarm log after** check box and enter the numbers of days in **Days** text box.

(3) Video Standard

Change and select the proper video system according to your camera video system. If the video system setting is wrong, the video would appear abnormal.

(4) Attention Please

Check the attentiveness of the person who is monitoring the system. You may set the number of times the Attention dialog box to appear in a day in **Times per day** text box.

When this feature is enabled, the **Attention** dialog box would appear. The person who is monitoring the system must enter the same number that appears from the left box at the right text box and then click **OK**.

(5) AutoScan Period

Set the display time gap from 3 to 10 sec. before it switches to the next camera.

(6) Login

Enable the conditions in Login section you want the system to automatically carry out.

- **Auto record when login**
Automatically start video recording when the NV DVR is executed.
- **Auto start Network when login**
Automatically connect to network when the NV DVR is executed.
- **Login to compact mode**
Switch to compact mode directly when the NV DVR is executed.
- **Silent Launch**
Enable the DVR system minimizes on the system tray automatically right after start up.
- **Guest Mode**
Automatically log in Guest mode when the NV DVR is executed. In guest mode, the functions are limited to preview and playback only.

(7) Miscellaneous

Enable the conditions in **Miscellaneous** section you want the system to perform.

- **Desktop Lock**
 - ✓ **Block window OS hotkey:** Deactivate the [Ctrl-Alt-Del] and [Windows] keyboard key functions.
 - ✓ **Block windows OS pop-up window:** To block any pop-up window from windows system.



- **Beep if no signal**
Make sound when the video signal is lost.
- **Mandatory Record**
Always record video when software is running
- **Enable Overlay**
To enhance video signal for better video quality.



Enable overlay doesn't support on NV3000T and NV5000 card.

- **Screen Saver**
Set a period time to enter screen saver mode when system idle.
- **Auto Scan Period**
Set the time gap of the Auto Scan function from 3 to 10 seconds. This automatically switches to the next video in cycle depending on the set time gap.
- **Playback Mode**
Select the mode of playback the video.
 - ✓ **Select date and time:** Select the date and time which user wants to playback.
 - ✓ **Play the last file:** Automatically playback the video from the last hour
 - ✓ **Instant Playback:** Automatically playback the video which has just recorded
- **Date Format**
Select the date format which wants to display in **Select date and time** playback mode

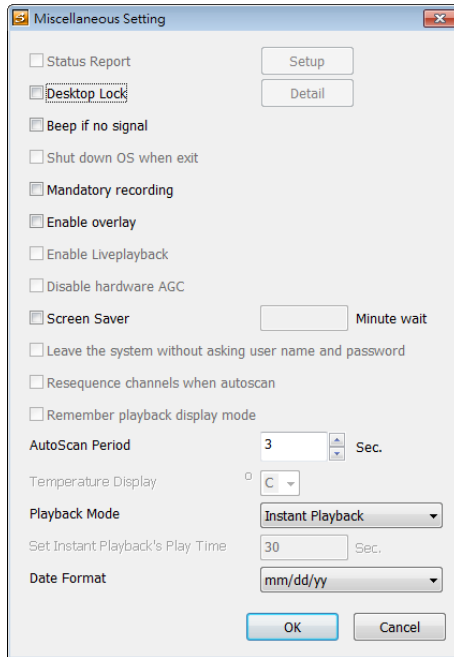

(8) Dual Monitor

To enable/disable dual monitor function.

(9) POS

Set from which camera screen to display the data from the POS equipment. Click **Setting** to enter the setup window.

■ Advanced Setting

To setup POS text display position, text font and color.

1. In the System Setting dialog box, POS section, click **Setting >> Advanced Setting**
2. Mark **Show POS Text** to allow POS data to be display on surveillance screen.
3. Select the POS data display position on surveillance screen – Left-Top, Left-Bottom, Right-Top, or Right-Bottom.
4. Mark **Multiple Windows** to allow more than one iPOS live data window (see also [iPOS Live](#) in Preview mode) display on the preview screen mode.
5. Mark **Save Window Position** that iPOS live data window position(see also [iPOS Live](#) in Preview mode) will be saved as next time call out position when close
6. Select the **Cameras** of iPOS live data that want to be display on Preview mode. To select all

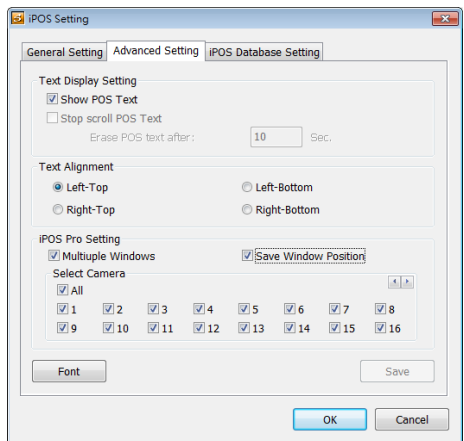

cameras, mark **All**.

7. To change the POS data font and color, click **Font**.
8. When it is done, click **Save** to complete the configuration.

■ POS Database Setting

Mark **Remove POS data after** the POS data will be delete from DVR hard disk on the day that user has setup.

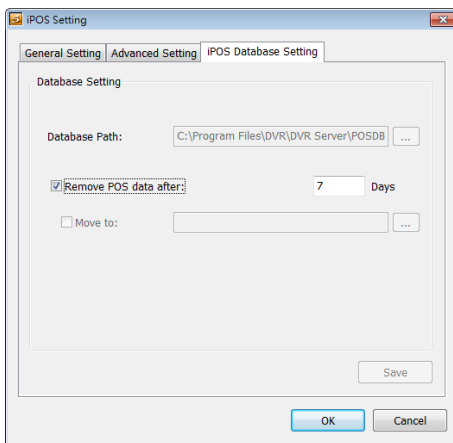

(10) UPS (Uninterruptible Power Supply)

Protect the system from damaging, such as power surges or brownouts. This automatically gives time to close the NV DVR properly when the battery backup power has reached the Shutdown when capacity below percentage level setting.

The UPS device must be connected to your computer (refer to your UPS user's guide).



The UPS application must meet Windows XP or Windows Vista system requirements.

(11) System Information

Display current NVR system firmware version.

Camera Setting

Select the camera from remote DVR servers to modify settings. In the Camera Setting windows, click **Update** to save and apply the new settings, click **Exit** to exit without saving, and click **Default1/Default2** to revert back to original factory setting.



Some of settings are not available to the IP camera.

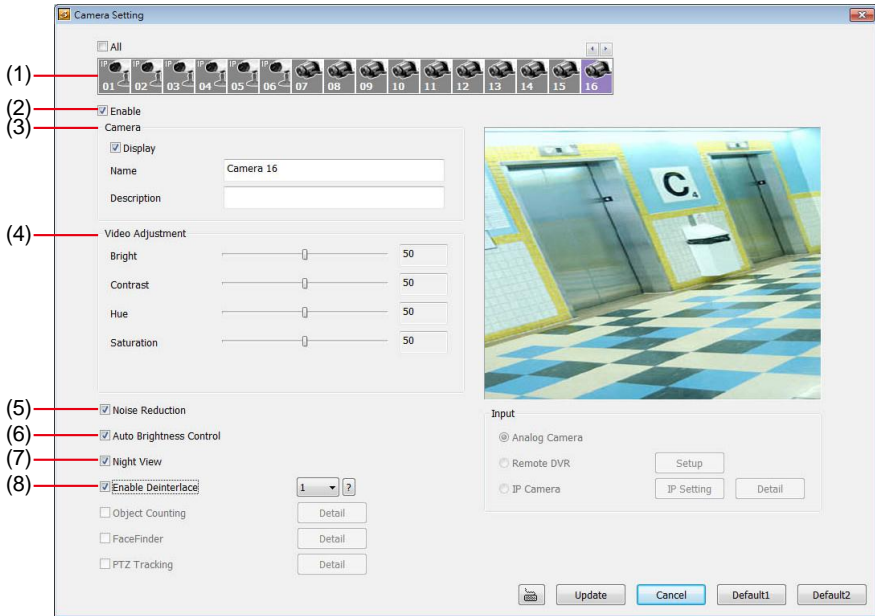

(1) Camera Icons

Select the camera number you want to adjust the video setting. To select all the cameras, enable the **ALL** check box. To select more than one camera, Right click on the camera icon. To select one camera only, Left click on the camera icon. The camera icon turns red when it is selected.

(2) Enable

Set to enable/disable the selected camera. When there is no video source on the camera, we suggest disabling it so that the system won't detect it as video loss error.

(3) Camera

- **Display**
Enable/disable to show the video. Even if the video of the selected camera is hidden you can still record the video and preview it in playback mode.
- **Name**
Change the camera name.
- **Description**
Add a short comment.

(4) Video Adjustment

Adjust the Brightness, Contrast, Hue and Saturation of the selected camera.

(5) Noise Reduction

Reduce undesirable video signal and improve the quality of the video.



Noise Reduction uses lots of CPU resource. Please use this feature only if it is really necessary.

(6) Auto Brightness Control

Automatically adjust the brightness.

(7) Night View

Automatically adjust the exposure to make the image more visible especially when the site is dark. You can only use this function when the ***Auto Brightness Control is enabled***.

(8) Enable Deinterlace

To enhance the video quality. Set the deinterlace mode to #1, if you are capturing motionless picture and #2, if it captures lots of movement.

Record Setting

In the Recording setup windows, click **OK** to accept the new settings, click **Exit** to exit without saving, and click **Default** to revert back to original factory setting.



Some of settings are not available to the IP camera.

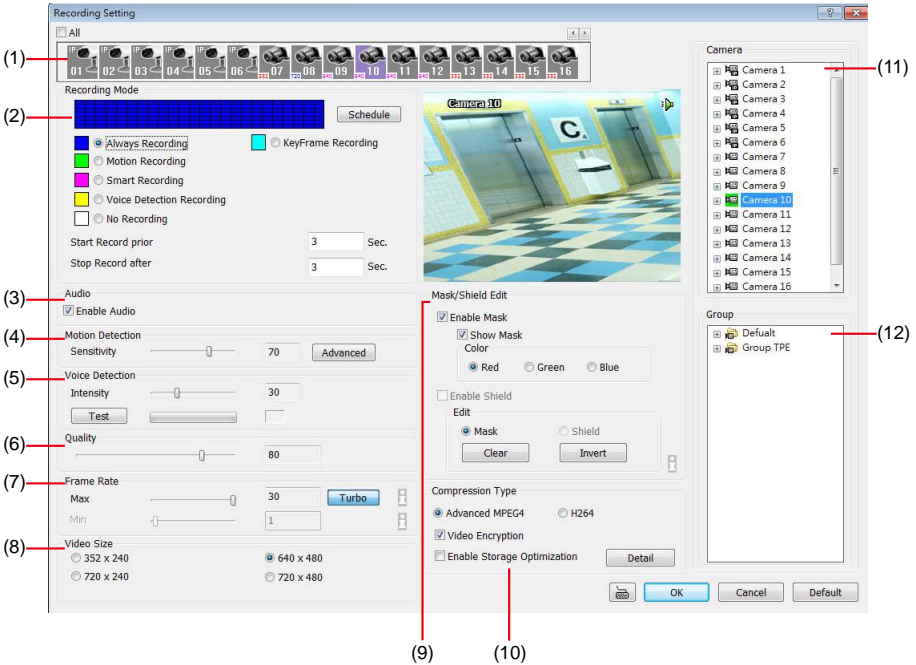

(1) Camera Icons

Select the camera number you want to set the recording setting. To select all the cameras, enable the **ALL** check box. To select more than one camera, **Right click** on the camera icon. To select one camera only, **Left click** on the camera icon. The camera icon turns red when it is selected.

(2) Recording Mode

The blocks from 00 to 23 represent the time in 24-hour clock. To record in full 24 hours, select the recording mode and click the **☉** button. If you want to only record at a particular time, click the colored block beside the recording mode then click on the time blocks. When the system starts recording a red triangle mark would appear at the upper left corner of the screen. The recording modes are listed below:

- **Always Recording**
Record the video from the selected camera and save it to the designated storage path
- **Motion Recording**
Start recording the video from the selected camera only when the system detects movement. Once a motion is detected, the system automatically saves the previous frames and stop based on the **Start Record Prior** and **Stop Record After** settings.
- **Smart Recording**
Automatically switch to recorded at the maximum frame rate setting once a motion is detected and if there is no motion, it records at the minimum frame rate setting. Set the maximum and minimum frame rate setting in [\(6\) Frame Rate](#) section.
- **Voice Detection Recording**
DVR system will record when the voice exceeds the intensity value in **Voice Detection** setting.

- **No Recording**

The system won't do any recording.

(3) Audio

Select to assign the audio channel of the selected camera. You can only assign one audio channel to one camera source. This way you can record both audio and video.



An Audio I/O card is required to use this function.

(4) Motion Detection

Adjust the sensitivity of the motion detector. The higher the value, the finer the sensitivity is detected. When it detects a motion, a green triangle mark would appear at the upper left corner of the screen.

(5) Video Detection

Adjust the intensity of the audio detector. The system detects sound when it exceeds the intensity value.

(6) Quality

Adjust the video quality. The higher the value, the lower the compression level and uses more hard disk space.

(7) Frame Rate

Set the maximum number of frames to be recorded during motion and motionless state. The frame rate ranges from 1 to 30 for NTSC and 1 to 25 for PAL. The higher the frame rate, it uses more hard disk space.

(8) Video Size

Select the size of the video and click the  button. The higher the size, the larger the file it create.

(9) Mask/Shield Edit

Mask, mark an area on the screen to disregards the motion in the marked area and to only monitor outside the marked area. In the Mask/Shield Edit section, activate the **Enable Mask/Enable Shield** check box. Click and drag a frame on the screen to create Mask area.

(10) Compression Type

User can refer the table below to check the NV card supports what type of compression. H264 is the latest and advanced video compression format that delivers better video quality and smaller file size but this uses more CPU resource. Advanced MPEG4 and MJPEG, both provide a standard for color picture compression rate. MPEG4 uses higher compression rate and smaller file size. While MJPEG uses slightly lower compression rate and bigger file size.

	MPEG4	MPEG 4 Encryption	H264	H264 Encryption	MJPG
NV3000T	✓	✓	✓	✓	✓
NV5000	✓	✓	✓	✓	✓
NV6000T	✓	✓	✓	✓	
NV7240	✓				
NV7480	✓				
NV8416T	✓		✓		
NV9416T			✓		

Video Encryption



When NV7480 card has enabled one channel encryption, the all channels will be encrypted.

Enable/disable to encrypt the recorded video that way only the person who knows the password can clearly view the video playback. The file size would become 10 to 30% more. Enabling the Video Encryption check box, you will be prompted to enter the password and retype the password for confirmation. Make sure not to forget the password for you would not be able to decrypt the video without it.

Video Encryption

Enter Password:

Confirm Password:

 Show Password

Warning:

Kindly note down your password. It is not possible to decode video stream without valid password. Password once lost cannot be recovered.

OK Cancel

The  symbol would appear on the upper right corner of the encrypted video screen. You may see the video during live recording. To decrypt the video, please refer to [Chapter 5.3.3](#).



■ Enable Storage Optimization

Enable/disable to save more storage space. Click **Detail** button to select the type of storage optimization.

- ✓ **Monochrome Mode:** The video will record in black and white.
- ✓ **Noise Reduction:** To do the noise reduction before compression.
- ✓ **Disable Video Enhancement:** To shutdown video enhancement function.

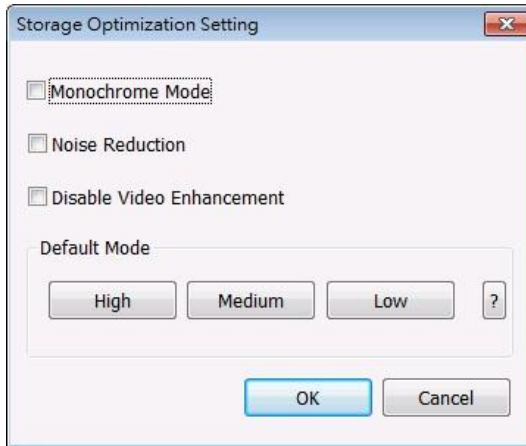

User also can select the Default Mode High/Medium/Low. Click ? button to view default mode definition.

(11) Group

Click to view the camera group that user has been setup in **Camera setup** (see also [Chapter 5.2.4](#)).

(12) Camera

Click to view the camera live video on screen.

Network Setting

In the Network Setting dialog box, click **Update** to accept the new settings, click **Exit** to exit without saving, and click **Default** to revert back to original factory setting. For the network service ports that use by DVR server, please see [Appendix C](#).

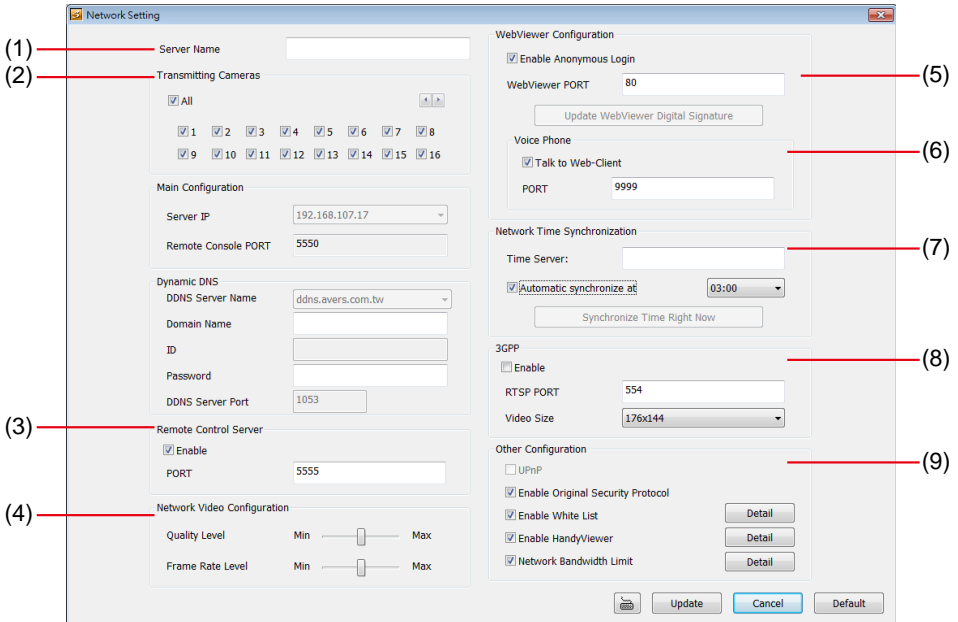

(1) Server Name

Assign a name for the DVR unit. Letters of the alphabet and numbers only.

(2) Transmitting Cameras

Select and click on the camera number in the Transmitting Camera section you want to make it accessible via internet using WebCam, Remote Console, PDA Viewer and Hand Viewer (still image). To select all the cameras, enable the **ALL** check box.

(3) Remote Control Server

Enable/disable remote control from remote application (ex. CMS). Enter the remote accessing port in **Port** column.

(4) Network Video Configuration

Set up the video quality and frame rate for viewing and transmitting to the remote program. Scrolling adjust bar to set the **Quality level** and **FrameRate level**.

(5) WebCam Port

Activate **Enable Anonymous Login** to remotely access the DVR server without the need of password. The default of WebCam port is 80.

(6) Voice Phone

Voice Phone is a 2-Way Talk feature that allows the client and server to talk via internet using microphone. Make sure both microphone and speakers work before using this feature. If the **Talk to Web-Client** is disabled, the person in the DVR server side can only hear the voice from the client side that is when the WebCam 2-Way Talk button is activated. (See also [Chapter 8.1 #6](#)). The default port of voice phone is 9999.

(7) Network Time Synchronization

Adjust the DVR system time same as network time server. Fill in the **Time Server** IP address or

domain name. Select **Automatic Synchronize** time to set automatic synchronize time on a daily basis.

(8) 3GPP

Enable 3GPP that allows user to use browser on the mobile phone to view recorded video. Just enter http://DVR_Server_IP/3GPP on the browser of mobile phone, and then, user will receive the recorded video from DVR server. Fill the RTSP PORT for 3GPP connection. Select the video size for transmitting to user's browser on the mobile phone.

(9) Other Configuration

- Enable Original Security Protocol

Enable new version DVR system to accept remote software with former version. For example, if user uses CMS version 7.1 and connect to NV DVR server with version 7.3, and then, user has to enable this option to make it work. It is due to that DVR system has some new security protocol in DVR with version 7.3 and newer version, and it's not compatible with old remote software.

- Enable White List

An access permit list for the remote accessing of DVR server. Enter the IP address and click **Add**. Or, enter a range of IP address and click **Add**. To delete the IP from the list, select the IP and click **Delete** button. To reset the input, click **Clear** button.

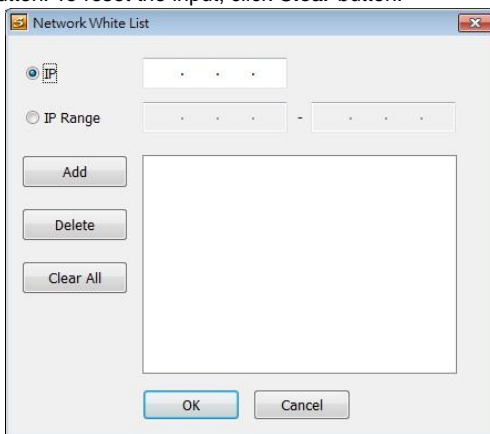

- Enable HandyViewer

Enable remote users to use a PDA or a mobile phone to access DVR server and select the video size and quality. (See also [Chapter 8.5](#) and [8.6](#))

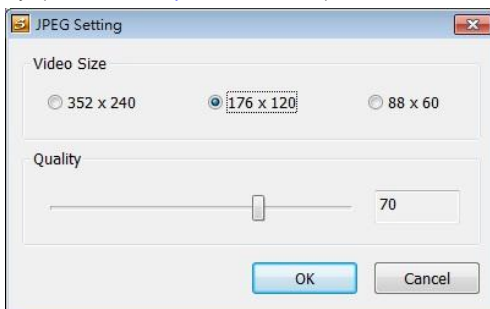

- **Network Bandwidth Limit**

- ✓ **By Channel:** Set the network bandwidth by each channel.
- ✓ **All:** Set the total network bandwidth consumption limit.

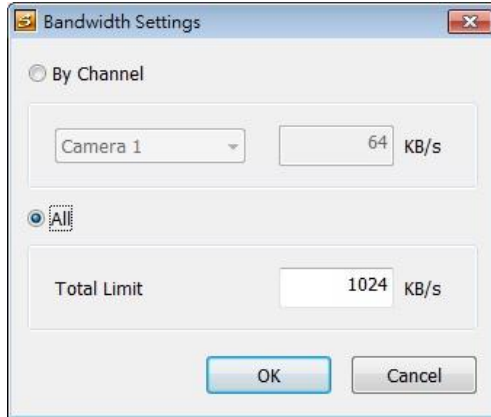

Schedule Setting

Schedule to record, backup, enable network, reboot and disable alarm of all the cameras either weekly or one time. The number from 00 to 23 represent the time in 24-hour clock. The left most column display the days in a week.

Calendar view showing October and November 2010. Selected date: 10/12/2010.

Record: WEEKLY ONE TIME

	00	01	02	03	04	05	06	07	08	09	10	11	12	13	14	15	16	17	18	19	20	21	22	23
10/10 Sun																								
10/11 Mon																								
10/12 Tue																								
10/13 Wed																								
10/14 Thu																								
10/15 Fri																								
10/16 Sat																								

Buttons: Clear, All, Update, Cancel

To Set the Schedule Setting:

1. Select the date in the calendar. Use and buttons to shift the calendar to the left or right.
2. Select the condition you want to schedule in the drop down list.

- Record

Activate all the cameras to start video recording at the set time based on the Recording setting (see also [Chapter 5.3](#)).

- **Backup**

Save another copy of all the data at the set time and specified backup path. NV DVR automatically updates and only backup the data that are not yet included in the archive. To assign backup path, click .

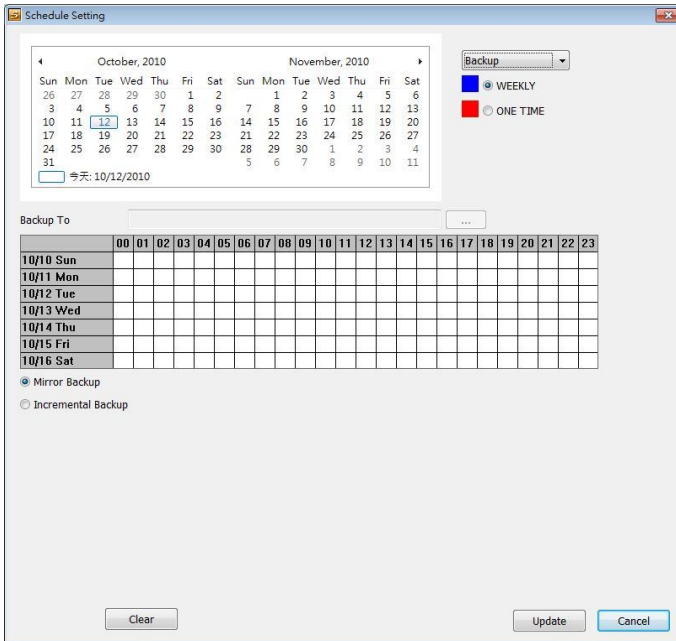

- ✓ **Mirror Backup:** Save a copy of all the data at the set time and specified backup path.
- ✓ **Incremental Backup:** Only backup the data that are not yet included in the archive from last time.



Make sure the backup folder and storage folder are not on the same drive.

- **Network**

Activate NV DVR remote system to access at the set time. After the appointed time, the Network function will be disabled. If the Network function is already enabled, the Network function will not be disabled when the appointed time has ended.

- **Reboot**

Restart the PC at the appointed time.



Make sure the Windows operating system is set **NOT** to require you to login user name and password. This way the system will be able to run NV DVR program.

- **Disable Alarm**

Deactivate the alarm at the set time temporarily.

3. Specify to either schedule it weekly or one time. Click to make a selection.
4. Click on the blocks to set the schedule (see also [Chapter 5.5.1](#)). Or click **All** to select all. To store the setting, click **Save**. To remove the settings, click **Clear**.
5. To end Schedule Setting, click **Update** to exit and accept the setting and **Exit** to exit without saving the setting.

Alarm Setting

In the Alarm Setting dialog box, click **Add** to insert and set new alarm setting, click **Delete** to remove the selected alarm setting, click **OK** to exit and save the setting, **Cancel** to exit without saving, and **Default** to revert back to original factory setting.

The screenshot shows the 'Alarm Setting' dialog box. It contains several sections:

- (1) Alarm Info:** Fields for 'No.' (1), 'Name' (Alarm1), and 'Description'.
- (2) Enable Time:** A 24-hour grid where blocks are selected to indicate when the alarm is active.
- (3) Conditions:** Radio buttons for 'Trigger if any' and 'Trigger if all'. Below are sections for Camera (Motion Detected, Video Loss, Missing or Suspicious Object/Scene Change, Audio Detected) and Sensor (High, Low, IP Camera Sensor).
- (4) Sensor:** A section for setting sensor conditions, including 'Continuous trigger duration' (0 seconds) and checkboxes for 'Abnormal Event', 'POS Keyword', 'Alarm Message', and 'Alarm Button'.
- (5) Alarm Reset:** A section for setting alarm reset conditions, including 'Alarm Reset Time' (5 seconds) and checkboxes for 'Abnormal Event', 'POS Keyword', 'Alarm Message', and 'Alarm Button'.
- (6) Action:** A list of actions with checkboxes and 'Detail' buttons: Launch E-Map, TV Out, Enlarge Camera View, Relay Output, IP Camera Relay, Play Warning Sound, Make Phone Calls, Send E-Mail, File Transmission via FTP, Start Recording, SMS / MMS, PTZ preset point, Alarm SOP, Send to CMS, Launch program, and Snapshot.
- (7) Alarm Setting List:** A table with columns 'No.', 'Name', and 'Description'. It contains two entries: '1 Alarm1' and '2 Alarm2'.

To set the Alarm Setting:

- Click **Add** to insert and set a new alarm setting. Click the items in the **(7) Alarm Setting List**, if you want to modify the alarm setting.
- In **(1) Alarm Setting number/Name/Description**, display the selected alarm setting number in the list below. Enter alarm name and description.
- In **(2) Enable Time**, the number from 00 to 23 represent the time in 24-hour clock. Select the time and click the block you want to activate or deactivate the alarm function. When it is deactivated the color of the block turns white.
- In **(3) Conditions**, you can set “**Trigger if any**” to activate if it falls to one of the conditions or “**Trigger if all**” to activate if it falls to all conditions.
 - In Camera section, select and click on the camera number (01 to 16) in **Motion Detected** and **Video Loss** to set the condition for the system to alarm.
 - In **Missing and Suspicious Object Detected**, click the camera number (01 to 16) and select the certain object on the screen (right click on camera number for detailed setting)), and when the certain object is missing or doubtful, the system will alarm. (see also [Chapter 5.9.12](#)) In **Scene Change**, when the camera has been moved, the system will alarm, too.
 - In **Voice Detection**, click the camera number (01 to 16) to the system to alarm when detect the abnormal voice.
- In **(4) Sensor**, select and click on the sensor number (use ◀ and ▶ to select the sensor) to set the condition for the system to alarm. If the sensor normal status is high, set the sensor condition to low (see [Chapter 5.7 step #4](#)).
 - Enable/disable the **Abnormal Event** check box, to set the condition of the event for system to alarm.
 - **System Reboot:** when the DVR system reboot without abnormal condition, the system

will send out the alarm message.

- **Abnormal Reboot:** when the DVR system reboot in irregular condition, the system will send out the alarm message.
- **Recording is switched off:** when the recording has been stopped, the system will send out the alarm message.
- **Network is switched off:** when the network connection of DVR system is lost, the system will send out the alarm message.
- **Hard Disk failed:** when the hard disk can't work normally, the system will send out the alarm message.
- **Temperature:** set a temperature limited of system for system to alarm. When DVR system temperature is over the temperature limited, the DVR system will send out the alarm.
- **VGA Temperature:** set a VGA temperature limited for alarm. When VGA temperature is over the limited that user has set, the DVR system will send out the alarm.



Temperature setting doesn't support on NV3000T/5000 card.

- **Illegal Entry:** any objects move between selected regions which user has set up in **Object Counting** section (see also [Chapter 5.2.1](#)), the system will send out the alarm. Select the entry (object moves from region 1 to 2 or from region 2 to 1) and camera for system alarm detection.

- Enable/disable the **POS Keyword** check box, to scan the data from the POS if it matches the keyword (see also [Chapter 5.9.11](#)).
 - Enable/disable the **Alarm Message** check box, to active with external alarm message by your own program. For the detail configuration, please contact the local reseller.
6. In **(5) Alarm Reset**, click the camera number (use ◀ and ▶ to select the alarm) to set the reset condition of alarm. Once alarm is reset, all alarm action will stop at the moment. If the sensor normal status is high, set the sensor condition to low.
 7. In **(6) Action**, you may now set the alarm action for the system to perform when the alarm condition is activated.
 - **Launch E-Map**
Display mini Emap screen.
 - **TV Out**
Switch to only display the video on TV from where the alarm is activated.

- **Enlarge Camera View**
Switch to only display video in Preview/Advanced mode from where the alarm is activated.
- **Send E-mail**
Send an electronic text message. To setup click **Detail** (see also [To Setup Send E-mail](#)).
- **File Transmission via FTP**
Upload file to remote computer thru FTP (File Transfer Protocol). To setup click **Detail** (see also [To Setup FTP](#)).
- **Start Recording**
Record the video from the selected camera. To setup click **Detail** (see also [To Setup Alarm Recording](#)).
- **Alarm SOP (Standard Operation Procedure)**
List the instructions to inform the person of what to do when the alarm is activated. To setup click **Detail** (see also [To Setup Alarm SOP](#)).
- **Send to CMS (Central Management System)**
Enable/disable the selected camera to send video to CMS when the alarm is activated (see also [To Setup CMS Setting](#))

To Setup Send E-mail Setting

Beside the Send Email check box, click **Detail**. In the E-mail Setting dialog box, click **OK** to exit and save the setting and **Cancel** to exit without saving the setting.



Gmail is supported now.

- **Mail Server**
Enter the SMTP Server and port. If your e-mail system requires user identification, enable **Authentication** check box and enter User ID and Password.
- **Mail**
To check if it is working, click **Test Account** button.
 - ✓ **From:** Enter the sender e-mail address.
 - ✓ **To and CC:** Enter the recipient email address and separate it with comma or a semicolon (;).
 - ✓ **Subject:** Enter the message title.
 - ✓ **Message:** Type the message.
- **Email Notice Setting**
 - ✓ **Notice Interval:** Set the period of time before it sends another e-mail notice.
 - ✓ **Embedded image:** Select the sending image's size and set the number of frames.
 - ✓ **Attach image when sensor is triggered:** When the sensor is triggered, the system will capture the image and send the image to the certain e-mail address with the alarm message.

The screenshot shows the 'E-Mail Setting' dialog box with the following fields and options:

- Mail Server:** SMTP Server (text field), Port (25), Authentication (checked checkbox), ID (text field), Password (text field).
- Mail:** From (text field), To (text field), CC (text field), Subject (text field), Message (text area), Test Account (button).
- Email Notice Setting:** Notice Interval (5 Minute), Embedded image (352x240, 1 frame), Attach image when sensor is triggered (Camera 1).
- Modem Dial up Setting:** Auto Dial up (unchecked checkbox), Auto Disconnect after (1 Minute).

Buttons: OK, Cancel.



If the alarm is not triggered by sensor, the system will depend on the setting of motion detected, video loss, audio detect, and sensor in alarm setting to send the alarm image and alarm message.

- Modem Dial up Setting

User may set the time to disconnect automatically, just enable the **Auto Disconnect after** check box and set time.

To Setup FTP Setting

1. Beside the File Transmission via FTP check box, click **Detail**.
2. In the FTP Setting dialog box, enter the FTP IP, port, user ID and password.
3. In **Number of Pic** text box, enter the number of sequence images that want to send when file is transmitting. The maximum number of picture can be transmitted are 16.
4. If user wants to send the recorded image before alarm occurs, enter the time that before alarm occurs in **Before alarm(sec.)**.
5. **Upload image:** User needs to select the camera that the images will be capture and send when the any alarm is triggered.
6. Click **OK** to exit and save the setting and **Cancel** to exit without saving the setting.

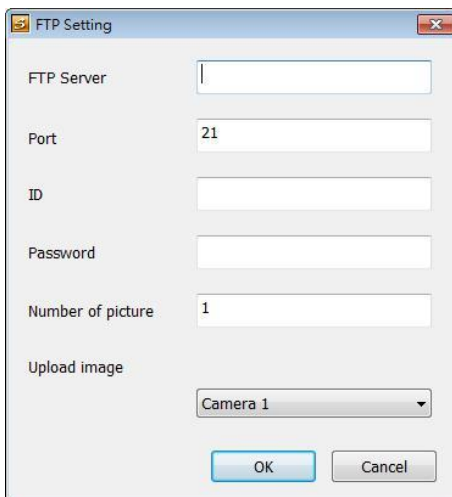

To Setup Alarm Recording Setting

1. Beside the Start Recording check box, click **Detail**.
2. In the Alarm Recording Setting dialog box, select the camera to enable/disable video recording. Enable **All** to select all cameras.
3. In the Frame Rate selection, select **As Setting** to record the number of frames based on the Recording Setting or **Max** to record the maximum of frames based on the available speed.
4. In the **Start Recording prior** text box, mark and set the number in second for the program to pre-recording before the alarm happen. The time range is 1~10 seconds.

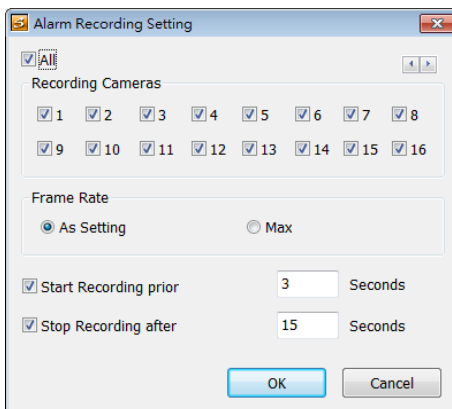

- When camera is Analog or IP camera and recording resolution less or equal to D1, the DVR system only record in key frame for pre-recording.
- When camera is Mega-pixel IP camera and the recording resolution is greater than D1, the DVR system won't do any pre-recording.

5. In the **Stop Recording after** text box, mark and set the number in second for the program to

continue recording after the alarm has ended. The time range is 1~600 seconds. If user doesn't mark and set the time, the alarm recording will continue recording until alarm is reset.
6. Click **OK** to accept the new settings and **Cancel** to exit without saving.

To Setup Alarm SOP

Beside the Alarm SOP check box, click **Detail**. In the step text boxes, type the standard protocol when the alarm is activated. When the alarm is activated, the Standard Operation Procedure dialog box will appear. Just click **Next** to see the next instruction, **Back** to see the previous instruction, **Finish** to end and **Abort** to terminate.

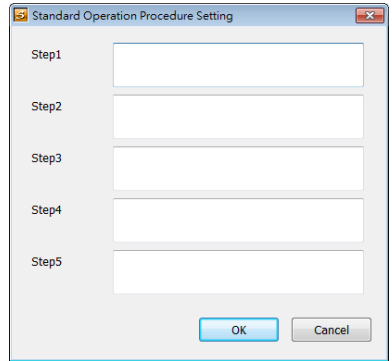

To Setup CMS Setting

Beside the Send to CMS check box, click **Detail**. Click **OK** to accept the new settings and **Cancel** to exit without saving.

- **CMS:** Select the camera to enable/disable sending the video to CMS.
- **Matrix:** Select the camera to enable/disable sending the alarm event video to CMS. The CMS site need to setup a matrix channel to receive the alarm event from DVR server site (please refer to CMS manual for detail)

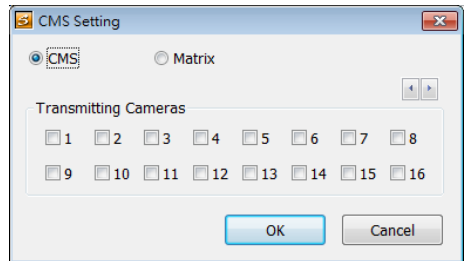

11.3 Remote Backup

Remote Backup is purely for backing up the *.dvr file from the NV DVR sever. You can select between Auto Backup and Manual Backup. Auto Backup continuously archives one hour of the recorded data at a time, starting from the specified date. As for Manual Backup, it only archives the recorded data of selected date.



- Please make sure the **UAC** function has disabled before install Remote setup.
- To disable UAC, please go to User Account setting in Control Panel to turn User Account Control off. **If UAC doesn't disable, it might cause abnormal operation of DVR system.**
- To back up the data, you must have at least 2G hard disk space.

To back up the recoded data from the NV DVR server:

1. Make sure you are connected to the internet.
2. Click **Start >> Program >> DVR >> Tool >> Remote Backup**
3. To add the DVR server, click **Add**

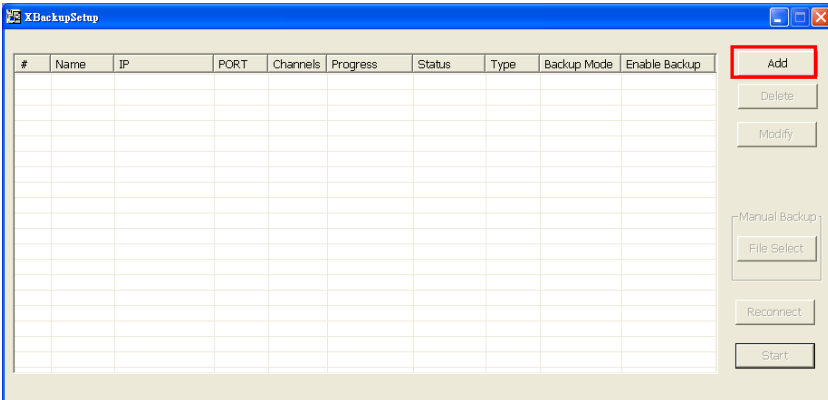

4. In the Add New DVR windows, enter the Name, IP, user ID, and password.

5. Select the Backup mode:

Auto Backup mode: the backup will automatically execute when the setup is completed

- In Begin Date drop down calendar, select the date from where to start
- Click **Add** to set the storage path.
- Click **Delete** to remove the selected storage path.
- Click **Schedule** to select/unselect the time you want to backup. The red block turns white when it is unselected.
- Enable/disable **Disk Recycle** check box, to automatically overwrite the oldest file when there is not enough free space to backup the file.

Manual Backup mode: the backup progress will start when user press the backup button

- Click **File Select** to choose the date, time and camera you want to back up.
- Click **Browse** to set the storage path.

6. Click **OK** to complete the adding DVR server. The added DVR server will display in Remote Backup main windows.

#	Name	IP	PORT	Channels	Progress	Status	Type	Backup Mode	Enable Backup
01	DVR 01	192.168.153.56	80	16		Connected	NV 7.1	Auto	<input checked="" type="checkbox"/> ON

7. Click **Start** to begin backup and click Stop to stop backup progress.

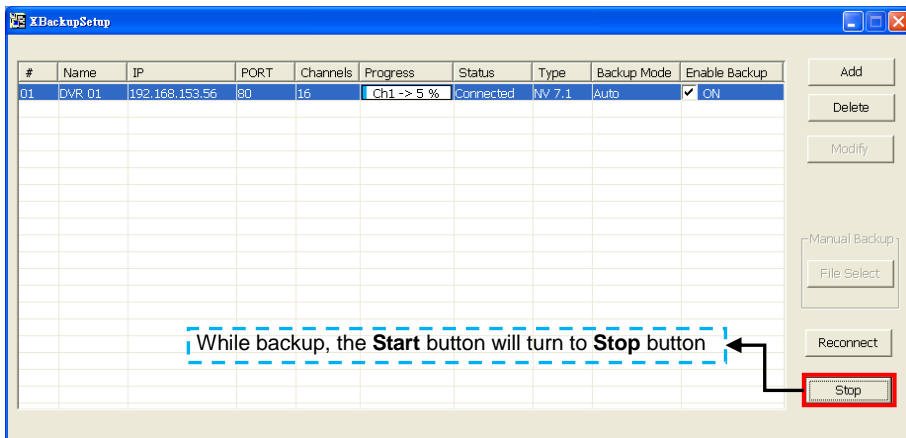

8. For manually backup, click **file select** button and select the DVR wants to backup.

11.4 iMatrix Application

The AVerMedia® iMatrix is a monitoring system that enables user to monitor remote DVR servers and CMS server through an internet connection. iMatrix can monitor and playback the video of remote DVR servers.

i iMatrix playback doesn't support on EB series.

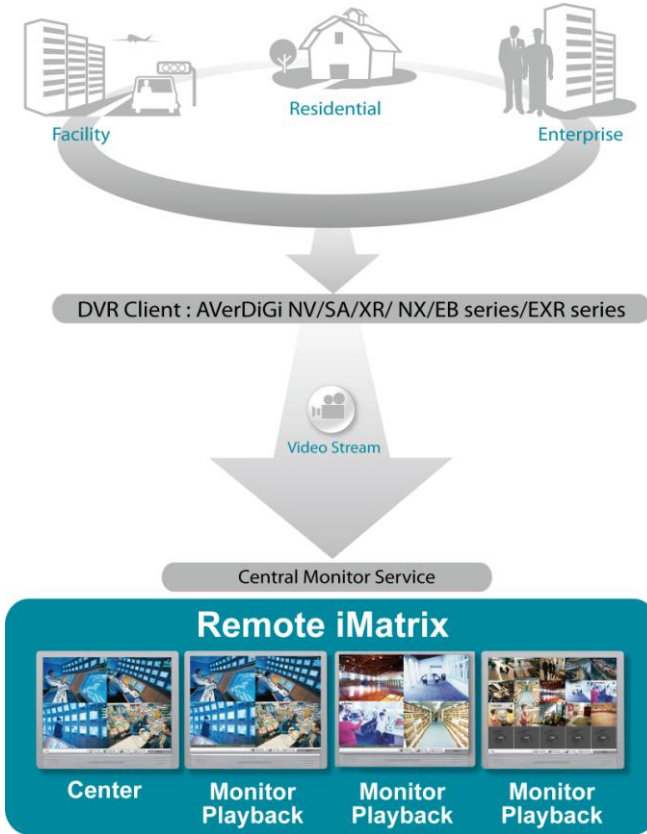

The iMatrix program supports Single, Dual, Triple and Four monitor displays. Please refer to [Chapter 2.11](#) for dual monitor setting.

11.4.1 Software Installation

This chapter describes how to install the iMatrix software.



- Before installing the software, make sure the Windows OS patches are up to date and the video graphic card driver is up to date.
- Please make sure the UAC function has disabled before install Remote setup.
- To disable UAC, please go to User Account setting in Control Panel to turn User Account Control off. **If UAC doesn't disable, it might cause abnormal operation of iMartix system.**

Minimum System Requirements

First, must verify if the computer meets the minimum system requirements.

- CPU : Pentium® 4 3.0GHz or above recommended
- OS : Windows XP Professional / Vista
- RAM : 512MB for dual display, 1GB for Quad display
- Hard disk : 120GB or higher
- Media : CD-ROM drive
- VGA : 32-bit high color SVGA graphics card with 128MB video memory and DirectDraw® / YUV Rendering Capability
- Audio : Sound card and speakers
- Internet capacity : 10/100 Base-T Ethernet card or Gigabit Ethernet

Installing the iMatrix Software in Windows XP/Vista/7

1. Place the installation CD into the CD-ROM drive then click **Install Web Tools**.
2. Please carefully read the license agreement. Click **Yes** to accept the agreement.



3. Enter the administrator ID and password and click **Next**.

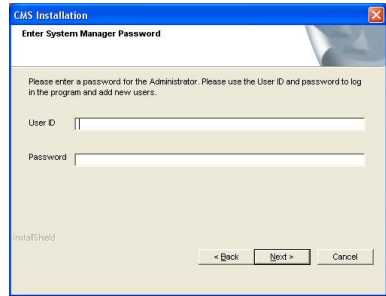

4. Select the install destination path if user wants install in different path beside default. Click **OK** and follow the on-screen instructions to complete the installation.
5. User may now run the iMatrix program. To run the application, click  on your PC desktop or click **Start > Programs > iMatrix > iMatrix**

11.4.2 Using the iMatrix

Running the iMatrix Software

To run the application, double-click  on your PC desktop or click **Start > Programs > iMatrix > iMatrix**.

For security purposes, iMatrix requires user to enter a User ID and Password before they can be accessed. When the Authorization dialog box appears, key in your User ID and Password. (If this is the first time, enter the one you have registered when installing the software.)



Using the iMatrix Application

iMatrix can remote monitor and playback recorded video of DVR servers and receive matrix events from remote DVR servers.

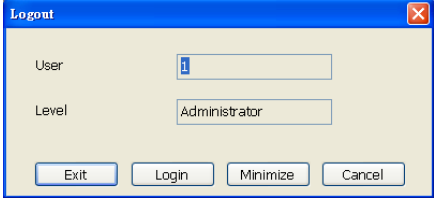

- Right-click mouse button and drag on screen can enlarge viewing. Right-click mouse button again to back to normal view.
- Press **F1** will display DVR information on upper right corner of channel screen. Press **F1** again to hide.

Name	Function
(1) Exit	<p>Call up the Logout dialog box.</p> <p>In the logout dialog box, you may do the following:</p>  <ul style="list-style-type: none"> - Click Exit to close the iMatrix program. Only the administrator is authorized to access this command. - Click Login to sign-in as a different user. - Click Minimize to reduce the iMatrix to taskbar button. - Click Cancel to close the Logout dialog box.
(2) Setup	<p>Configure the iMatrix settings. Only the administrator is authorized to access this command. (see also Chapter 11.4.3)</p>
(3) Monitor Controller	<p>Call out monitor set selection window to select the monitor set for monitoring (see also Using Monitor Controller).</p>
(4) PTZ	<p>Call out PTZ control panel (see also Familiarizing the Buttons in PTZ Camera Controller)</p>
(5) Audio	<p>Enable/Disable audio play</p>
(6) DVR Name bar	<p>Display the name of monitor DVR</p>
(7) Preview icon	<p>The icon indicates the channel is in preview status.</p>

Using Monitor Controller

User can use Monitor Controller to switch different monitor set for monitoring and add/delete the channel in monitor set.

- i** User needs to create monitor set in order to using Monitor Controller. To create monitor set, please go to Setup > Camera (see also [Camera setup](#))

1. Click 
2. The Monitor Controller window will show up as below shown:

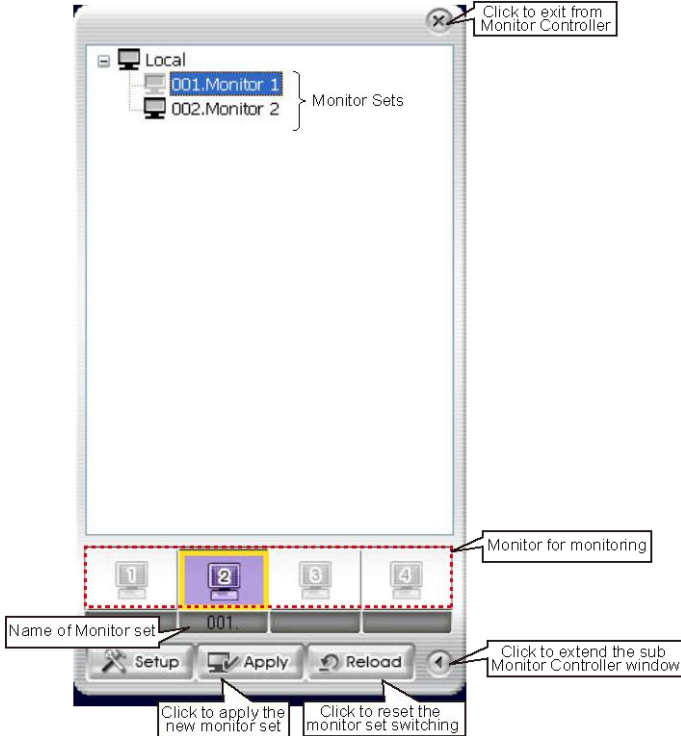

- i**
- Right-click on monitor set and select **Recover** to un-select the monitor set.
 - The monitor set is gray that indicates the monitor set is selected and been monitored
 - The monitor 1 ~ 4 are purple that indicate the monitor is monitoring.
 - Right-click on monitor and select the **Recover** to reset the monitor.

3. Drag the monitor set from monitor list to the monitor (1 ~ 4) and click **Apply** to activate it. To reset the monitoring group, click **Reload**.
4. To configure monitor set, click arrow button to expand the sub Monitor Controller window.
5. Select the monitor. The DVR servers are included in the monitor set will list on sub Monitor Controller window. The lower part of window display all monitored channels in the monitor set.
6. To add new channels, click the DVR server to un-fold the available cameras. Drag the camera to the blank channel block that has no channel number and name display.
7. Click **Apply** to refresh the monitor set.

8. To delete channels from monitor set, right-click on channel and select **Recover**.
9. Click arrow button to close the sub window.

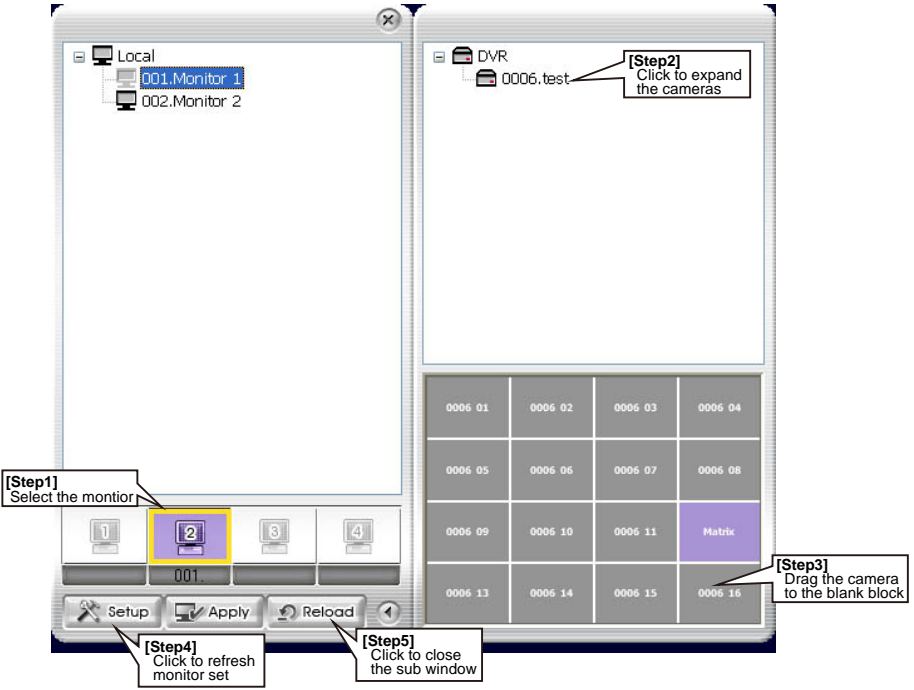

Right-click on channel block and select **Recover** to delete the channel form monitor set.

Familiarizing the Buttons in PTZ Camera Controller

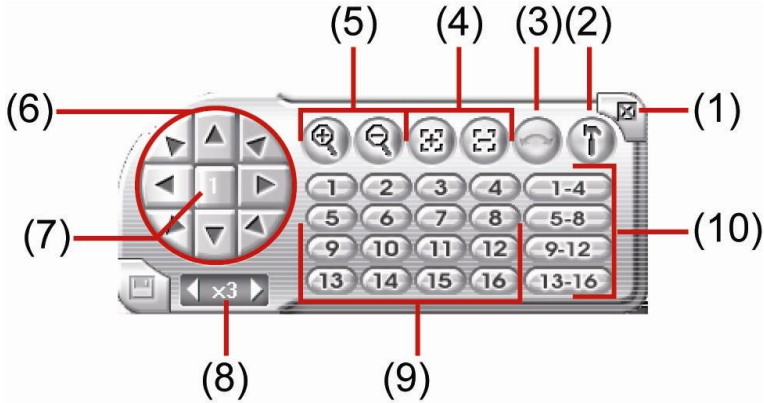

Name	Function
(1) Close	Exit PTZ camera controller.
(2) Setup	Select PTZ cameras.
(3) AutoPan	Operate the PTZ cameras automatically based on the selected camera group preset position number.
(4) Focus +/-	Adjust the focus manually to produce clear image.
(5) Zoom +/-	Zoom in and out the image.
(6) Direction buttons	Adjust and position the focal point of the PTZ camera.
(7) Camera ID pane	Display the PTZ camera number that is being operated.
(8) Camera lens speed controller	Adjust the moving speed of the PTZ camera lens.
(9) Camera preset position number	Move the PTZ camera to the preset point.
(10) Group AutoPan	Select to automatically operate PTZ camera in group.

11.4.3 Customizing the iMatrix System

In the iMatrix application, click the  button to customize the iMatrix system. In the Authorization dialog box, enter the administrator User ID and Password.

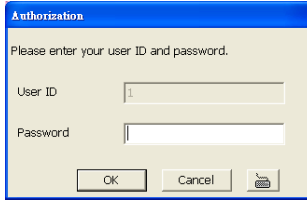

When the iMatrix configuration setup selection appears, select and click the buttons you want to change the setting.



System Setting

In the System Setting dialog box, click **OK** to accept and start to reload the new setting, and **Cancel** to exit without saving.

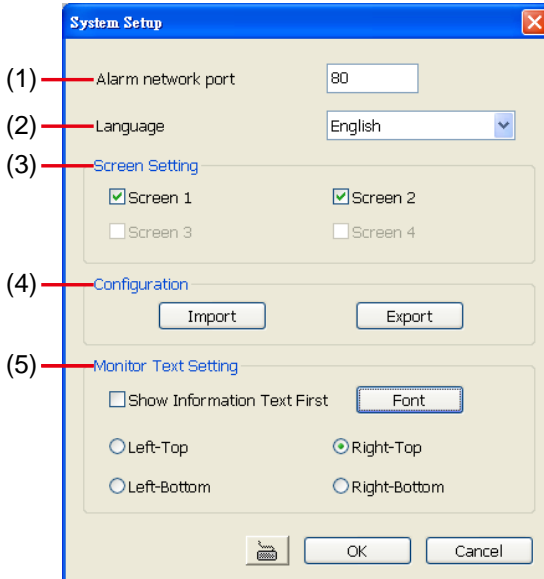

(1) Alarm Network Port

Select a port for receiving alarm video from DVR server. Any network service port can be assigned as long as the port doesn't conflict with current network service.

(2) Language

Customize the system to display the tool tips and dialogs based on the selected language. By default the set language is in English.

(3) Screen Setting

Enable/disable monitor for monitoring. Only the monitors that connect with iMatrix system are available for enable/disable.

(4) Configuration

Import / Export the iMatrix system configuration

(5) Monitor Text Setting

Enable/disable the camera information display and display position on the monitor screen.

Show Information Text First: Enable/disable the DVR information display on monitor screen.

Click **Font** to select the text font and colour.

DVR Setup

Add the DVR servers for monitoring.



iMatrix only supports 16 DVR servers

To Add and Remove DVR Server

- 8. Click **Setup**.
- 9. In the Authorization dialog box, enter the administrator User ID and Password.
- 10. Click **DVR**.
- 11. In the DVR Setup section, click **Add** to insert, **Delete** to remove and **Edit** to modify DVR server setting.

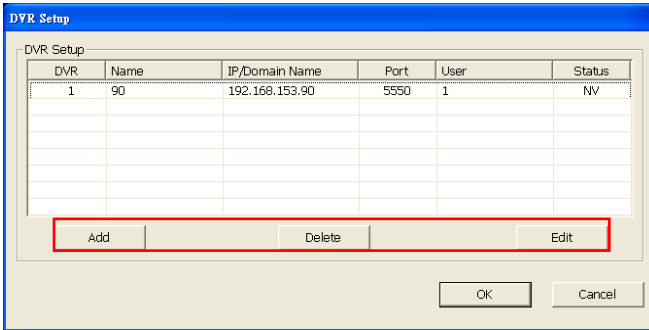

- 12. To continue adding a DVR, in the text box, enter the name, IP/Domain, Login User, Password, Confirm Password of the remote DVR server.
- 13. Select the **Video Quality** for video display on the iMatrix system monitor screen. When the video quality is high, user can enable **Show POS message** box and the POS message will also display on the iMatrix system monitor screen.

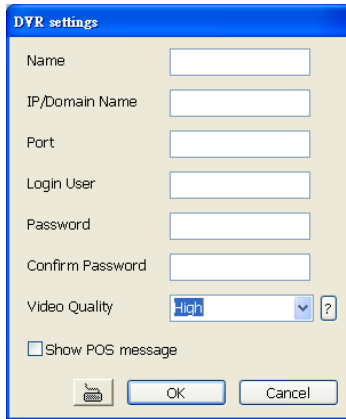

The image shows a 'DVR settings' dialog box with a blue title bar. It contains several input fields: 'Name', 'IP/Domain Name', 'Port', 'Login User', 'Password', and 'Confirm Password'. Below these is a 'Video Quality' dropdown menu set to 'High' with a help icon. There is also a checkbox for 'Show POS message'. At the bottom are three buttons: a printer icon, 'OK', and 'Cancel'.

14. Click **OK** to accept the new setting and **Cancel** to exit without saving the new setting.
15. And then, the iMatrix system will try to connect with DVR server. If the connecting time takes too long, user can click **Disconnect** button to cancel the connect action.

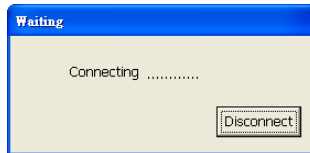

The image shows a 'Waiting' dialog box with a blue title bar. The main area contains the text 'Connecting' and a 'Disconnect' button at the bottom right.

Camera Setup

Select the camera from different DVR servers in order to monitor in one group. The selected cameras will be played on **Monitor** screen (see [Using the iMatrix Application](#)).

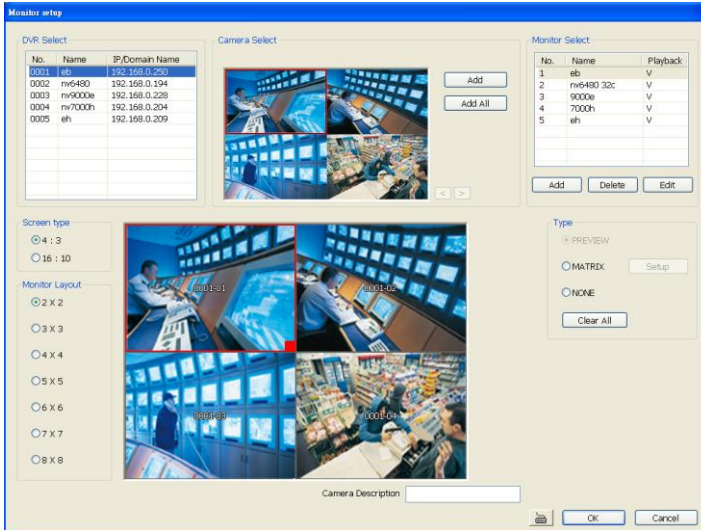

1. Click **Setup**.
2. In the Authorization dialog box, enter the administrator User ID and Password.
3. Click **Camera**.
4. Click **Add** to create a monitor set. The monitor set can be added up to 1000 monitor set. Click **OK** to save the setting.

- **Name:** Enter a name for the monitor set (12 characters only).

- **Playback Setting**

- **Enable Playback:** Enable/disable to allow playback on monitor screen.
- **Show POS message:** Enable/disable display POS information on monitor screen.
- **Start Playback Before:** Enter the time (sec.) when start playback will start from the present time backward the time user has setup.

- **Preview Setting**

- **Frame Rate:** User can set the camera transmitting **Frame Rate** for preview, but the real transmitting frame rate depends on camera setting.

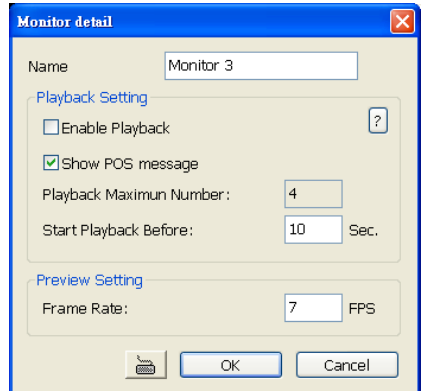

5. After the Monitor set has been created, select the DVR server. And then the camera channels of the DVR server will display on the **Camera Select** window. User can combines different cameras from different DVR servers as a monitor set. And all camera channels can be selected by different Monitor set raptly. Click < and > to go back previous and go to next camera screen.
6. User can depend on the monitor size to select the screen type – **4:3** (regular screen monitor) or **16:10** (width screen monitor). The 4:3 and 16:10 screen type support different monitor layout.
7. Select the camera that user wants to add, and then click **Add** button. To add all the cameras, click **Add All**. The selected camera channel will be added to **Monitor Layout** window. User can

add up to 64 cameras in 4:3 screen type and 80 cameras in 16:10 screen type. To remove the camera from the **Monitor Layout** window, select the camera and right-click to select **Recover**. To delete all cameras, click **Clear All** button. User can enter a description for a channel. Click a camera in **Monitor Layout** window and enter the description in **Camera Description**. The camera description will display on the channel of the monitor screen.



User can drag the camera channel to Monitor Layout window without using **Add** button.

8. In Monitor Layout window, user also can set the channel to receive the alarm events from DVR server.
 - **Matrix:** set the selected channel to receive and display the alarm event from selected DVR servers. Click **Setup** to select the DVR servers. Enable the **Retrieve time** to set a period time (0 ~ 255 sec) for alarm event to display. If the retrieve time doesn't enable, the alarm event will display on screen until next alarm event come in.



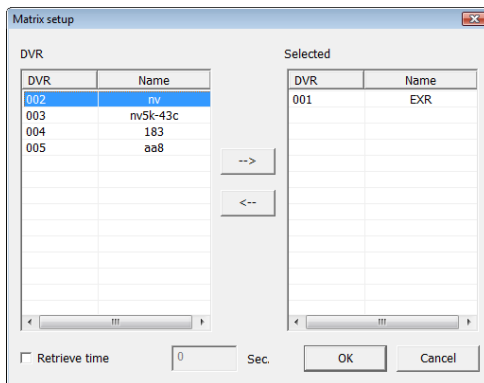

On the DVR site, user need to enable and configure the matrix to send iMatrix (please refer to **Alarm Setting** of DVR manual).



9. Click **OK** to save the setup. To exit without saving, click **Cancel**.
10. To delete the monitor set, select the monitor set in **Monitor Select** windows and click **Delete** button.
11. To modify the monitor set, select the monitor set in **Monitor Select** windows and click **Edit** button.
12. To viewer different monitor set, click **Monitor Controller** from iMatrix main UI and drag the monitor set to the monitor and press **Apply** button.
13. Also, user can call up the PTZ camera control panel by click **PTZ** button and select the PTZ camera to operate. The PTZ icon will be available when there are PTZ cameras in Monitor set.



- Click right mouse button and drag on screen can enlarge viewing. Click right mouse button again to back to normal view.
- Press F1 will display DVR information on upper right corner of channel screen. Press F1 again to hide.
- Click on channel to view in full screen. Press **Esc** to back to multiple channel screens.
- The  icon indicates the channel is in preview status.
- The  icon indicates the channel is in playback status.

User Setting

iMatrix supports 256 user account that includes operator and administrator account.

1. Click **Setup**.
2. In the Authorization dialog box, enter the administrator User ID and Password.
3. Click **User**
4. Select the Authorization Level – **Operator** or **Administrator**. User can define each operator/administrator account's authority of DVR server and Monitor set. **Only the administrator is authorized to close and customize the iMatrix system.**
5. Enter the **Name**, **Description**, **Password**, and **Confirm password** of the account.
6. Select the DVR servers that allow this account user to preview and playback. The DVR server with check mark means is selected.
7. Select the Monitor set that allow this account user to view. The Monitor set with check mark means is selected.
8. User can assign a valid date for Operator user. Select **Being Date** and **End Date** to assign a valid date for operator account. **The account only will be available during the assigned date.**
9. Click **OK** to accept the new settings and **Cancel** to exit without saving.

User Setting

Authorization Level
 Operator Administrator

Name Password
Description Confirm Password

Allowed DVR View For This User

NO.	DVR Name	Watch This DVR
1	EXR	v
2	nv	v
3	nv5k-43c	v
4	183	v
5	aa8	v

Click to select

Allowed Monitor View For This User

NO.	Monitor Name	Watch This Monitor
1	Monitor 1	v
2	Monitor 2	v
3	Monitor 3	v
4	Monitor 4	v
5	Monitor 5	v
6	Monitor 6	v
7	Monitor 7	v

Enable Valid Date Configuration

Begin Date End Date

11.4.4 Using the Playback Function

User can playback recorded video from the remote side of the DVR server.

- i** - Playback function must be enabled. Please go to **Setup > Camera** and select the monitor set and enable the playback function (see also [Camera setup](#))
- iMatrix playback doesn't support on EB series.







1. Double-click the preview icon of channel and the channel will start playback.

- i** The  icon indicates the channel is in playback status.



2. User can use the playback control button to operate the playback.

- i** - Click channel to switch to full screen mode for operating playback control button easily.
- iMatrix only supports 4 channel playback at the same time.

Button	Function
	Begin: Move at the beginning of video.
	Slower: Play the recorded video file at the speed of 1/2X, 1/4X, 1/8X, 1/16X, or 1/32X.
	Pause: Briefly stop playing
	Play: Play the video
	Next: Go to the next frame.
	Faster: Play the recorded video file at the speed of 2x, 4x, 8x, 16x or 32x.
	End: Go to the end of the video.

Button

Function



Select recorded vide to playback from remote DVR server hard disk. Select the date on the calendar and the time from 00 to 23 to where to start playing the recorded video file.

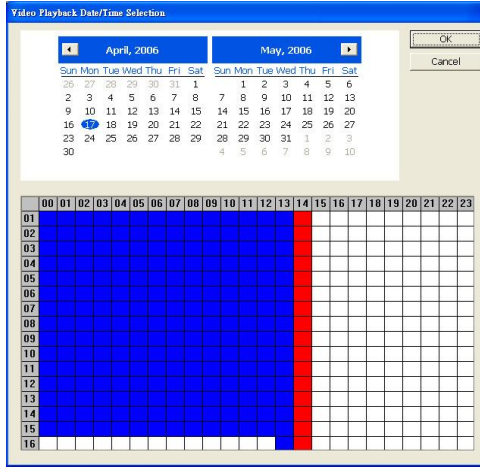



x1 10:00:01.261

Display playback speed and recoding time.



Chapter 12 Using the Remote Control Server

The bundled Remote Control Server enables the PC with Central Management System program (CM3000) installed in it remotely access the NV DVR server. You may need to manually run this program for CMS access the NV DVR server. To run, click **Start > Programs > DVR > Remote Control Server**. The  remote control server icon appears on the taskbar when the remote control server is enabled. To change the port setting or stop server, right-click  icon and then make a selection.



User can also setup Remote Control Server in DVR **Network** setting, please see [Chapter 5.4 #5](#).

Appendix A Registering Domain Names

DDNS (Dynamic Domain Name Service) is a data query service mainly used on the Internet for translating domain names into Internet addresses. It allows remote clients to intelligently search dynamic servers without any previous enquiring for servers' Internet addresses.

In order to take advantage of this intelligent service, first register your domain name. User has two choice of the DDNS server site can register the domain name. Choice the one you like and register the domain name.

I. Register the Domain Name on <http://ddns.avers.com.tw>

1. User Login

Browse the website ddns.avers.com.tw with Microsoft IE or Netscape Navigator to access the following dialog.

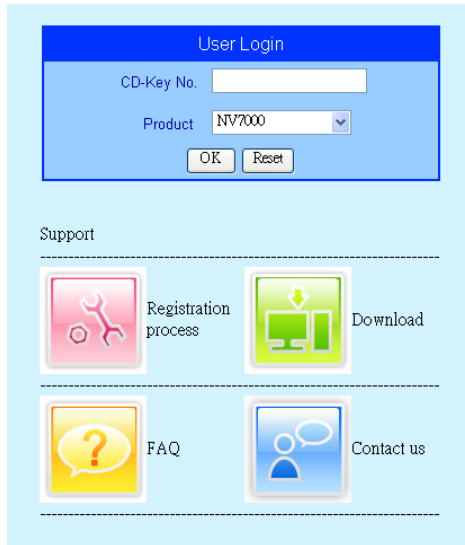

- First input CD-Key number and select the product name.



One of CD-Key allows user to register two domain names. One of domain name can be used by Dispatch serve.

- Then click **OK** to login or **Reset** to clear the previous input.

2. User Information

Please provide the following user information, **Host Name** (user can choose any name he/she likes except the one violence with other users), **Password**, **E-mail**, **Company**, and **Country**. And then, click **OK** to complete the domain name registration.



Note that Host Name and Domain Name (AVerMedia.avers.com.tw) are the replacement for Internet address while a remote client tends to search a dynamic server.

II. Register the Domain Name on <http://www.dyndns.com>

1. Open the browser on your PC and enter the URL <http://www.dyndns.com>
2. Select the **Create Account** from the main page.

DynDNS.com
by Dynamic Network Services Inc.

User: Pass:

[Lost Password?](#) - [Create Account](#)

About Services Account Support News

LIKE YIN AND YANG.
Buy Custom DNS and get Domain Registration for just \$10.
Learn more about our **Custom DNS service**

New to DynDNS.com?
Take our **new tour** and see what we do

DNS Services
DNS for static and dynamic IP address

MailHop Services
Ensure reliable email delivery

News Outage Causes Multiple Website Failures (DynDNS Customers Not Affected)

Resources
What is DNS?
DNS Tools
Home Solutions
Business Solutions

Services
DNS Hosting
Free Dynamic DNS
Email Relay
Domain Names

Support
DynStatus
Knowledge Base
24/7 Premier Support
Update Clients

Follow Us
Our News
Twitter @dyninc
LinkedIn
DNS Ninjas | Facebook

© 1998-2009 [Dynamic Network Services Inc.](#) - [Legal Notices](#) - [Privacy Policy](#) - [Contacts](#)

3. Enter the **Username, Email, Retype Email, Password, Retype Password**, and read the policy agreement.
4. Click **Create Account**.

DynDNS.com
by Dynamic Network Services Inc.

User: Pass:
[Lost Password?](#) - [Create Account](#)

About Services Account Support News

My Account
 Create Account
 Login
 Lost Password?

Search

Create your DynDNS.com account

User Information

Username:

Email: Activation instructions will be sent here.

Retype Email:

Password:

Retype Password:

Mailing Lists (optional)

Newsletters:

Press-releases:

Format: HTML Plain Text

Acceptable Use & Privacy Policy

Privacy Policy:
 We [do not sell](#) your account information to anyone, including your email address.

I agree to the [Acceptable Use Policy \(AUP\)](#), and my mailing list subscriptions.

5. User need to do the email verify in order to complete the account apply. Go to your mail account that user has used to register the account to find the confirm mail.

DynDNS.com
by Dynamic Network Services Inc.

User: Pass:
[Lost Password?](#) - [Create Account](#)

About Services Account Support News

My Account
 Create Account
 Login
 Lost Password?

Search

One more step to go...

We've sent an email to avers@avermedia.com, to verify your account.
 Please check your inbox and click on the confirmation link.

If you do not receive the email in the next few minutes you can try [resending it](#).

Thanks for choosing DynDNS.com!

© 1998-2009 [Dynamic Network Services Inc.](#) - [Legal Notices](#) - [Privacy Policy](#) - [Contacts](#)

6. After account has been confirmed, user can login to your account.

The screenshot shows the DynDNS.com account summary page for user 'myown'. The page is divided into several sections:

- Header:** DynDNS.com logo, 'by Dynamic Network Services Inc.', and 'Logged In User: myown' with links for 'My Services', 'My Cart', and 'Log Out'.
- Navigation:** A yellow bar with links for 'About', 'Services', 'Account', 'Support', and 'News'.
- Left Sidebar:** A vertical menu with links for 'My Account', 'My Services', 'Account Settings', 'Billing', 'My Cart (0 Items)', and a 'Search' box.
- Main Content Area:** Titled 'Account Summary for myown', it is divided into three columns:
 - My Services:** Includes a description 'View, modify, purchase, and delete your services.' and a list of links: 'My Zones/Domains', 'Add Zone/Domains Services' (highlighted with a red box), 'My Hosts', 'Add Host Services', 'Spring Server VPS', 'Dynamic DNS Pro', 'MailHop Outbound', 'Network Monitoring', 'SSL Certificates', 'Recursive DNS', 'Support', 'Premier Support', 'Contact Support', and 'DNS Service Level Agreement'.
 - Billing:** Includes a description 'Update your billing information, complete a purchase, and view invoices.' and a list of links: 'View Shopping Cart', 'Active Services', 'Order History', 'Billing Profile and Vouchers', 'Renew Services', 'Auto Renew Settings', and 'Sync Expirations'.
 - Account Settings:** Includes a description 'Update your email address, set preferences, and delete your account.' and a list of links: 'Change Email Address', 'Change Password', 'Change Username', 'Contact Manager', 'Mailing Lists', 'Move Services', 'Preferences', and 'Close Account'.
- Footer:** Copyright information: '© 1998-2009 Dynamic Network Services Inc. - Legal Notices - Privacy Policy - Contacts'.

7. Select **Add Zone/Domains Service** to register the domain name.

Appendix B Configure UPnP

NV DVR application support UPnP function that can automatically configure the port setting of DVR into the local router.

Please make sure the following items are true for the UPnP to workable:

- Window XP service Pack 2 is require
- Window XP must be configured to use UPnP
- UPnP must be enabled on your router (Please contact your local router dealer or refer to the router user manual for the UPnP configuration on router)

Enabling UPnP in Window XP

1. Go to **Start > Setting > Network Connections**. And then, the below windows appear:

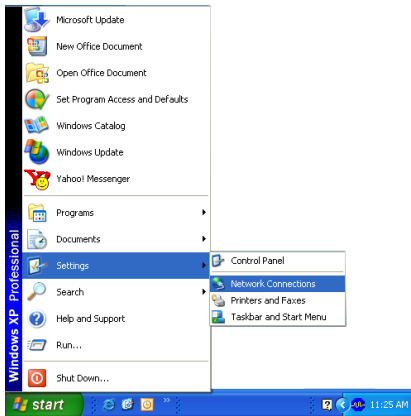

2. Right click on **Local Network Connection** icon and select **Properties > Advance** tab. The below windows appear:

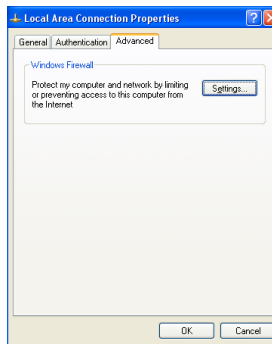

3. Click **Settings** button and select **Exception** tab. The **Windows Firewall** appears.

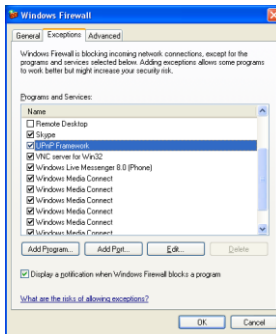

4. Mark the **UPnP Framework** check box and click **OK**.

Appendix C Network Service Port

The following table shows the ports that DVR server uses for certain network service.

	Port #	Variable
Remote Console (CM 3000)	5550	Y
WebCam	80	Y
2-way audio	9999	Y
Remote Control (CM3000/RC1000)	5555	Y
DVR POS	5150	Y
DVR DDNS (Upload / Download)	53 / 1053	N

Appendix D Mobile Viewer Comparison

	PDAViewer	JAVAViewer	3GViewer	iPhone Viewer	SmartViewer	Handy Viewer
Live	1/4CH Live Video	1CH Live Video	1CH Live Video	1CH Live Video	1CH Live Video	1CH Image
Playback	Yes	No	No	No	No	No
Audio	Yes	No	No	No	No	No
Remote I/O Control	Yes	No	No	No	No	No
PTZ	Yes	Yes	No	No	No	No
Compatibility	PDA with Windows Mobile OS	Symbian smart phone or smart phone with JAVA2.0 support	Smart phone with 3GPP streaming support	Apple iPhone	Windows Smart Phone OS	General Cell Phone with internet browser support

LIMITED WARRANTY

AVerMedia Information, Inc. warrants that this product to be free of defects resulting from faulty manufacturing or components under the following terms:

WARRANTY LENGTH

Labor is warranted for 5 years.

Parts is warranted for 3 years.

WHO IS PROTECTED

This warranty is enforceable only by the first consumer purchaser.

WHAT IS AND IS NOT COVERED

Except as specified below, this warranty covers all defects resulting from faulty manufacturing of this product. The following are not covered by the warranty.

1. Any product on which the serial number has been defaced, modified, or removed.
2. Damage, deterioration, or malfunction resulting from:
 - a. Accident, abuse, misuse, neglect, fire, water, lightning, or other acts of nature, commercial or industrial use, unauthorized product modification, or failure to follow instructions included with the product.
 - b. Misapplication of service by someone other than the manufacturer's representative.
 - c. Any shipment damages. (Claims must be made with carriers.)
 - d. Any other cause that does not relate to a product defect.
3. Cartons, cases, batteries, cabinets, tapes, or accessories used with the product.
4. AVerMedia Information, Inc. does not warrant that this product will meet your requirements; it is your responsibility to determine the suitability of this product for your purpose.

WHAT WE WILL AND WILL NOT PAY FOR

We will pay labor and material expenses for covered items. However, we will not pay for the following:

1. Removal or installation charges.
2. Shipping charges.
3. Any incidental charges.

EXCLUSION OF DAMAGES

THE MANUFACTURER'S SOLE OBLIGATION AND LIABILITY UNDER THIS WARRANTY IS LIMITED TO THE REPAIR OR REPLACEMENT OF A DEFECTIVE PRODUCT AT OUR OPTION. THE MANUFACTURER SHALL NOT, IN ANY EVENT, BE LIABLE TO THE PURCHASER OR ANY THIRD PARTY FOR ANY INCIDENTAL OR CONSEQUENTIAL DAMAGE (INCLUDING, BUT NOT LIMITED TO, DAMAGES RESULTING FROM INTERRUPTION OF SERVICE AND LOSS OF BUSINESS) OR LIABILITY LIMITATIONS OF IMPLIED WARRANTIES.

There are no other oral or written warranties, expressed or implied, including but not limited to those of merchantability or fitness for a particular purpose. Any implied warranties are limited in duration to 15 months from the date of purchase.

STATE LAW AND YOUR WARRANTY

This warranty gives you specific legal rights, and you may also have other rights granted under state law. These rights vary from state to state.

CONTACT INFORMATION

Taiwan & International
No. 135, Jian Yi Rd., Chung Ho City, Taipei, Taiwan
TEL: 886-2-2226-3630 ext.2582
FAX: 886-2-2226-7241
Web Site: www.averdigi.com